

CITY OF LITTLE ROCK

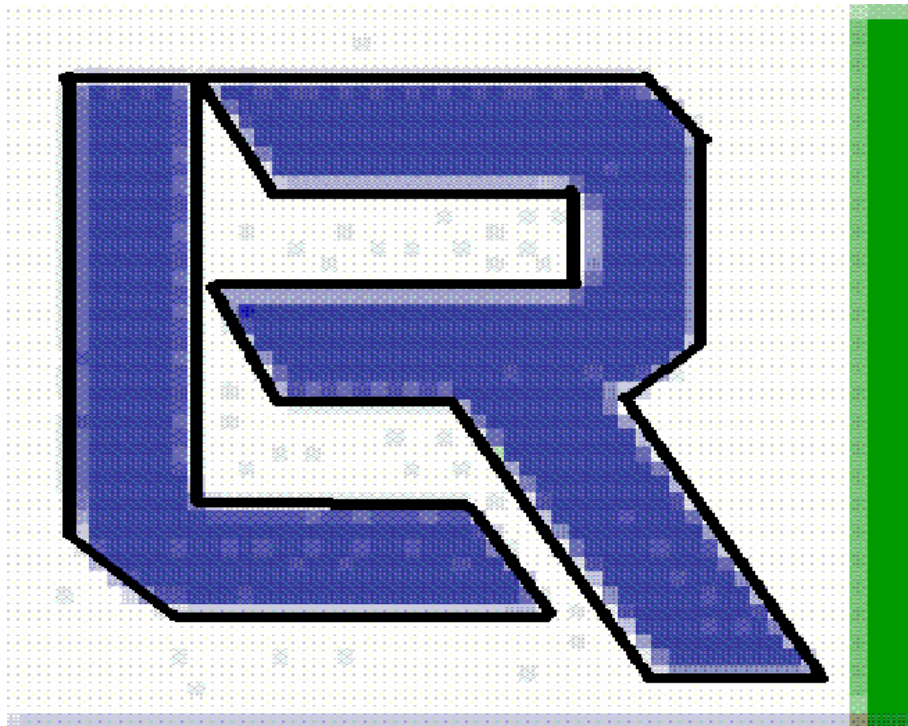

STORMWATER MANAGEMENT AND DRAINAGE MANUAL

PUBLIC WORKS DEPARTMENT
701 WEST MARKHAM STREET
LITTLE ROCK, ARKANSAS 72201

AUGUST, 2012 UPDATE

~~DECEMBER, 2007 UPDATE~~

~~NOVEMBER, 2011 UPDATE~~



City of Little Rock

Department of
Public Works

701 West Markham
Little Rock, Arkansas 72201
371-4800

March 29, 1985

TO: THE USER OF "THE STORMWATER MANAGEMENT
AND DRAINAGE MANUAL"

In order to ensure that you will receive all changes or
additions to this manual, please complete the following:

NAME: _____

FIRM: _____

COMPLETE MAILING ADDRESS:

REMOVE AND RETURN THIS SLIP TO:

CITY OF LITTLE ROCK
PUBLIC WORKS DEPARTMENT
ENGINEERING SECTION
701 WEST MARKHAM STREET
LITTLE ROCK, AR 72201

STORMWATER MANAGEMENT & DRAINAGE DESIGN MANUAL

OUTLINE

ORDINANCE

POLICIES

INTRODUCTION

SECTION I - Submittal Procedures

SECTION II - Determination of Storm Runoff

SECTION III - Storm Drains and Drainage Appurtenances

SECTION IV - Culvert Hydraulics

SECTION V - Stormwater Detention

SECTION VI - Pavement Drainage Design

SECTION VII - Storm Inlets

SECTION VIII - Storm Sewer Design

SECTION IX - Open Channels

SECTION X - Erosion and Sediment Control

SECTION XI - General Requirements to Prevent Stormwater Damage

APPENDICES

A. SCS-TR-55 Tabular Method Using Micro-Computer

B. Detention Pond Design, Example, and Channel Routing

C. Tabular Method Hydrograph Distributions

D. Tabular Method Example Problem

E. Load, Proof, and Correct Programs

F. Interpolation and Use of Distribution Data Program

Bibliography

TABLES

TABLE

2-1	Runoff Coefficients for Rational Method - Land Use Characteristics
2-2	Runoff Coefficients for Rational Method - Composite Analysis
2-3	Rational Method Runoff Curve Numbers by Zone and Land Use - SCS TR-55
2-4	Direct Runoff Values by RCN's and Rainfall Amounts
2-5	RCN/Runoff Inches
3-1	Minimum Slope Required to Produced Scouring Velocity
3-2	Permissible Velocities for Channels Lined with Grass
3-3	Roughness Coefficients "n" for Storm Drains
3-4	Junction or Structure - Coefficient of Loss
3-5	Head Loss Coefficients Due to Obstructions
3-6	Head Loss Coefficients Due to Sudden Enlargements and Contractions
4-1	Values of Entrance Loss Coefficients "Ke"
4-2	Reduction Factors for Velocity of Approach
4-3	Culvert Discharge - Velocity Limitations
9-1	Computation of Composite Roughness Coefficient for Excavated and Natural Channels
9-2	Classification of Vegetal Covers to Degree of Retardance
9-3	Permissible Velocities for Channels Lined with Grass

FIGURES

FIGURE

- 1-1 Topographic Symbols and Abbreviations
- 2-1 Zone Map for Runoff Potentials: SCS TR-55
- 2-2 Time of Concentration Nomograph
- 2-3 Average Velocities for Overland Flow
- 2-4 Intensity - Duration - Frequency Chart: 0-24 hrs.
- 2-5 Intensity - Duration - Frequency Chart: 5-60 min.
- 2-6 Runoff Curve Number Work Sheet
- 2-7 TR-55 Work Sheet
- 3-1 Uniform Flow for Pipe Culverts
- 3-2 Critical Depth of Flow for Circular Conduits
- 3-3 Velocity in Pipe Conduits
- 3-4 Uniform Flow for Concrete Elliptical Pipe
- 3-5 Critical Depth for Elliptical Pipe
- 3-6 Velocity in Elliptical Pipe
- 3-7 Uniform for Pipe-Arch
- 3-8 Critical Depth for Flow for Pipe-Arch
- 3-10 Minor Head Losses Due to Turbulence at Structures
- 3-11 Minor Head Losses Due to Turbulence at Structures
- 3-12 Minimum Easements for Drainage and Utilities
- 4-1 Inlet Control
- 4-2 Outlet Control
- 4-3 Culvert Design
- 4-4 Type 1 - Culvert Flowing Part Full with Outlet Control and Tail Water Depth Below Critical Depth

FIGURES

FIGURE

- 4-5 Culvert Flowing Part Full with Outlet Control and Tail Water Depth Above Critical Depth
- 4-6 Culvert Flowing Part Full with Inlet Control
- 4-7 Type IV-A, Culvert Flowing Full with Submerged Outlet
- 4-8 Type IV-B, Culvert Flowing Full with Partially Submerged Outlet
- 4-9 Critical Flow for Box Culverts
- 4-10 Uniform Flow for Box Culverts
- 4-11 Headwater Depth for Box Culverts with Inlet Control
- 4-12 Head for Concrete Box Culverts Flowing Full
- 4-13 Critical Depth of Flow for Circular Conduits
- 4-14 Uniform Flow for Pipe Culverts
- 4-15 Velocity in Pipe Conduits
- 4-16 Head for Concrete Pipe Culverts Flowing Full
- 4-17 Headwater Depth for Concrete Pipe Culverts with Inlet Control
- 4-18 Deph of Cover Tables
- 4-19 Pipe Beddings
- 4-20 Pipe Beddings
- 5-1 Modified Retention Hydrograph
- 5-2 Headwater Depth for Concrete Pipe Culverts with Inlet Controls
- 6-1 Reduction Factor for Allowable Gutter Capacity
- 6-2 Nomograph for Flow in Triangular Channels
- 6-3-6-31 Gutter Flow Curves

FIGURES

FIGURE

- 7-1 Depressed Curb-Opening Inlet: Type A-1 and C-1
- 7-2 Depressed Grate Inlet: Type A-2 and C-2
- 7-3 Depressed Combination Inlet: Type A-3 and C-3
- 7-4 Drop Inlet (Grate Covering): Type A-5
- 7-5 Undepressed Curb-Opening: Inlet Type A-1 and B-1 (Recessed)
- 7-6 Undepressed Grate Inlet: Type A-2 and B-2
- 7-7 Undepressed Combination Inlet: Type A-3 and B-3 (Recessed)
- 7-8 Inlet Capacity: Type A-7 and A-4
- 7-9 Inlet Capacity: Type A-2 and A-5
- 7-10 Capacity for Inlets on Grade
- 7-11 Ratio of Intercepted to Total Flow for Inlets on Grade

- 9-1 Uniform Flow for Trapezoidal Channels
- 9-2 Ditch Design Form
- 9-3 Flow Velocity for Unlined Channels (Bare Soil)
- 9-4 Maximum Permissible Depth of Flow for Unlined Channels (Bare Soil)
- 9-5 Maximum Permissible Depth of Flow for Channels Lined with Fiberglass Roving (Single and Double Layer)
- 9-6 Flow Velocity for Channels Lined with Fiberglass Roving Tacked with Asphalt, Single Layer
- 9-7 Flow Velocity for Channels Lined with Fiberglass Roving Tacked with Asphalt, Double Layer
- 9-8 Maximum Permissible Depth of Flow for Channels Lined with Jute Mesh

FIGURES

FIGURE

- 9-9 Flow Velocity for Channels Lined with Jute Mesh
- 9-10 Maximum Permissible Depth of Flow for Channels Lined with Excelsior Mat
- 9-11 Flow Velocity for Channels Lined with Excelsior Mat
- 9-12 Maximum Permissible Depth of Flow for Channels Lined with Erosion Net
- 9-13 Flow Velocity for Channels Lined with Erosion Net
- 9-14 Maximum Permissible Depth of Flow for Channels Lined with Bermuda Grass, Good Stand, Cut to Various Lengths
- 9-15 Maximum Permissible Depth of Flow for Channels Lined with Grass Mixtures, Good Stand, Uncut
- 9-16 Maximum Permissible Depth of Flow for Channels Lined with Common Lespedeza of Various Lengths
- 9-17 Flow Velocity for Channels Lined with Vegetation of Retardance A
- 9-18 Flow Velocity for Channels Lined with Vegetation of Retardance B
- 9-19 Flow Velocity for Channels Lined with Vegetation of Retardance C
- 9-20 Flow Velocity for Channels Lined with Vegetation of Retardance D
- 9-21 Flow Velocity for Channels Lined with Vegetation of Retardance E
- 9-22 Maximum Permissible Depth of Flow for Channels Lined with Rock Riprap
- 9-23 Flow Velocity for Channels Lined with Rock Riprap
- 9-24 Flow Velocity for Channels Lined with Rock Riprap
- 9-25-9-30 Trapezoidal Channel Design Charts

FIGURES

FIGURE

- 10-1 Erosion Control Methods: Stabilize Construction Entrance; Diversion Dike; Straw Bale Dike
- 10-2 Erosion Control Methods: Barrier with Gravel Outlets and Level Spreader
- 10-3 Erosion Control Methods: Diversion Channels and Sediment Basin
- 10-4 Erosion Control Methods: Embankment Section through Riser and Earth Outlet Sediment Trap
- 10-5 Erosion Control Methods: Flexible Down Drain and Temporary Down Drainage Structure
- 10-6 Erosion Control Methods: Down Drain and Storm Inlet Sediment Trap

Chapter 29 STORMWATER MANAGEMENT AND DRAINAGE*

***Cross references:** Buildings and building regulations, Ch. 8; landscaping and tree protection, Ch. 15; fills for storm sewers, drains, etc., § 30-166; subdivisions, Ch. 31; zoning, Ch. 36.

State law references: Authority to legislate on matters pertaining to municipal affairs, A.C.A. § 14-43-601 et seq.

-
- Art. I. In General, §§ 29-1--29-35
 - Art. II. Stormwater Management and Drainage System, §§ 29-36--29-60
 - Art. III. Stormwater Management and Drainage Plans, §§ 29-61--29-85
 - Art. IV. Design Criteria and Performance Standards, §§ 29-86--29-145
 - Div. 1. Generally, §§ 29-86--29-95
 - Div. 2. Design Criteria, §§ 29-96--29-125
 - Div. 3. Performance Standards, §§ 29-126--29-145
 - Art. V. Bonds, Maintenance Assurances and Drainage Approvals, §§ 29-146--29-165
 - Art. VI. Land Alteration Regulations, §§ 29-166--29-196
 - Div. 1. Generally, §§ 29-166--29-185
 - Div. 2. Grading Permit and Grading and Drainage Plan, §§ 29-186--29-196

ARTICLE I. IN GENERAL

Sec. 29-1. Definitions.

The following words, terms and phrases, when used in this chapter, shall have the meanings ascribed to them in this section, except where the context clearly indicates a different meaning:

Agriculture means all farm enterprises such as crop land, forage production, animal husbandry, dairy and poultry, and floriculture.

Base flood means the flood that has a one (1) percent chance of being equaled or exceeded in any given year, i.e., the one-hundred-year flood.

Bond means any form of security for the completion or performance of the stormwater management and drainage plan or the maintenance of drainage improvements, including surety bond, collateral, property or instrument of credit, or escrow deposit in an amount and form satisfactory to the public works department.

Building means any structure built for the support, shelter or enclosure of persons, animals, chattels or movable property of any kind.

Channel means a course of perceptible extent which periodically or continuously contains moving water, or which forms a connected link between two (2) bodies of water, and which has a definite bed and banks.

Clear cutting means removing of substantially all merchantable standing trees.

Clearing means the act of cutting, harvesting, removing from the ground, burning, damaging or destroying trees, stumps, hedge, brush, roots, logs, or scalping existing vegetation.

Conduit means any open or closed device for conveying flowing water.

Control means the hydraulic characteristic which determines the stage-discharge relationship in a conduit. The control is usually critical depth, tailwater depth, or uniform depth.

Detention means the temporary detaining or storage of floodwater in reservoirs, on parking lots, on rooftops and other areas under predetermined and controlled conditions accompanied by controlled release of the stored water.

Detention basins means any manmade area which serves as a means of controlling and temporarily storing stormwater runoff. The facility normally drains completely between spaced runoff events, e.g., parking lots, rooftops, athletic fields, dry wells, oversized storm drain pipes.

Detention pond means a stormwater detention facility which maintains a fixed minimum water elevation between runoff events except for the lowering resulting from losses of water due to infiltration or evaporation.

Developer means a person engaged in land alteration activities which are not excluded by section 29-187.

Development means any change of land use or improvement on any parcel of land.

Differential runoff means the volume and rate of flow of stormwater runoff discharged from a parcel of land or drainage area which is or will be greater than the volume and rate which pertained prior to proposed development or redevelopment existed.

Drainage approval means a certificate of approval issued by the public works department based upon an approved final stormwater management and drainage plan. The final stormwater management and drainage plan must accompany the building permit application or be submitted with the proposed construction plans.

Drainage easement means authorization by a property owner for use by another party for all or any portion of his land for a drainage and adjoining utility purposes.

Engineer of record means a registered professional engineer in the state who shall supervise the design and construction of the project and shall be acceptable to the public works department.

Erosion means the wearing away of land by action of wind, water or gravity.

Floodplain means a land area adjoining a river, stream, watercourse or lake which is likely to be flooded.

Floodway means the channel of a river or other watercourse and the adjacent land areas that must be

reserved in order to discharge the base flood without a cumulative increase of the water surface elevation more than a designated height.

Forestry operation means an operation conducted on land owned or leased by a major forestry industry corporation for the systematic harvest of timber.

Freeboard means a factor of safety expressed as the difference in elevation between the top of the detention basin dam, levees, culvert entrances and other hydraulic structures, and the design flow elevation.

Frequency means the reciprocal of the exceedance probability.

Grading and drainage plan means the plan required before a grading permit can be issued.

Grading permit means the permit issued by public works for grading, clearing, harvesting, filling, excavating, quarrying, tunneling, trenching, construction, or similar activities in the city.

Habitable dwelling unit means a dwelling unit intended and suitable for human habitation.

Imminent construction means the installation of a foundation or erection of a structure without unreasonable delay following land-alteration activities as determined by the director of public works.

Land alteration means the process of grading, clearing, filling, excavating, quarrying, tunneling, trenching, construction or similar activities, unless excluded by section 29-187.

Major storm easement means a privately maintained area designed to carry the one-hundred-year storm with no obstructions allowed such as fill or fences that would impede floodwater flow. Properly designed landscaping that does not impede floodwater or endanger adjacent property may be allowed.

Minor storm easement means a publicly maintained area designed to carry the ten-year (or fifty-year for CBD area) storm, provide access for maintenance, and prevent channel obstructions.

Mulching means the application of plant or other suitable materials on a soil surface to conserve moisture, reduce erosion, and aid in establishing plant cover.

Off-stream detention means temporary storage accomplished off-line, i.e., not within a principal drainage system.

One-hundred-year peak flow means the peak rate of flow of water at a given point in a channel, watercourse or conduit resulting from the base flood.

One-hundred-year storm means a rainstorm of a specified duration having a one (1) percent chance of occurrence in a given year.

On-site detention means temporary storage of runoff on the same land development site where the runoff is generated.

On-stream detention means temporary storage of runoff within a principal drainage system, i.e., in the receiving streams or conduits.

Permittee means a person to whom a permit is granted.

Plat means a legally recorded plat of a parcel of land subdivided into lots with streets, alleys, easements and other land lines drawn to scale.

Project means any development involving the construction, reconstruction or improvement of structures and/or grounds.

Rational method means an empirical formula for calculating peak rates of runoff resulting from rainfall.

Responsible party means any person or entity having control of the property subject to this chapter.

Retention facility means any type of detention facility not provided with a positive outlet.

Sediment means rock, sand, gravel, silt, clay or other material deposited by action of wind, water or gravity.

Sedimentation basin means the storage area created by a barrier or dam built across a waterway or at other suitable locations to retain rock, sand, gravel, silt, clay or other material.

Stormwater management and drainage manual or *drainage manual* means the set of drainage policies, analysis methods, design charts, stormwater runoff methods, and design standards used by the city as the official design guidelines for drainage improvements consistent with this chapter.

Stormwater runoff means water that results from precipitation which is not absorbed by the soil, evaporated

into the atmosphere or entrapped by ground surface depressions and vegetation, which flows over the ground surface.

Structure means any object constructed above or belowground. Pipes, manholes and certain other utility structures which exist underground may be excluded from this definition.

Swale means a shallow waterway.

Time of concentration means the estimated time in minutes required for runoff to flow from the most remote section of the drainage area to the point at which the flow is to be determined.

Tributary area means all of the area that contributes stormwater runoff to a given point.

Undisturbed perimeter strip means a perimeter or boundary strip around land areas which have been cleared, cut or filled, which is required to remain in a natural state, including topography, trees and vegetation. Enhancements such as additional landscaping or other treatments may be used if approved by the public works department.

Uniform channel means a channel with a constant cross section and roughness.

Universal soil loss equation means a method developed by the agricultural research service, USDA, and used to estimate soil erosion based on a rainfall, soil erodibility, slope of the land, length of slope and plant cover. The basic form of the equation is:

$$E = R K L S C P$$

Where:

TABLE INSET:

E	=	soil loss, in tons per acre per year.
R	=	rainfall factor.
K	=	soil erodibility factor.
LS	=	slope length gradient factor.
C	=	vegetative cover factor.
P	=	conservation practice factor.

Examples of soil loss calculations are contained in the stormwater management and drainage manual.

Watercourse means any surface stream, creek, brook, branch, depression, reservoir, lake, pond or drainageway in or into which stormwater runoff flows.

Wet bottom basin means a detention basin intended to have a permanent pool.

(Code 1961, § 35A-6; Ord. No. 15,243, § 1(5A-14), 2-17-87; Ord. No. 15,833, § 1, 4-3-90; Ord. No. 18,361, § 1, 9-26-00; Ord. No. 19,353, § 1, 7-19-05)

Cross references: Definitions and rules of construction generally, § 1-2.

Sec. 29-2. Penalty.

Any person convicted of a violation of any of the provisions of this chapter shall be punished as provided in section 1-9.

Sec. 29-3. Purpose.

In order to promote the public health, safety and general welfare of the citizens of the city, the provisions of this chapter are intended to:

- (1) Reduce property damage and human suffering.
- (2) Minimize the hazards of personal injury and loss of life due to flooding, to be accomplished through the approval of a stormwater management and drainage plan that:
 - a. Establish the major and minor stormwater management systems.

- b. Define and establish stormwater management practices and use restrictions.
- c. Establish guidelines for handling increases in volume and peak discharges of runoff.

(Code 1961, § 35A-5)

Sec. 29-4. Interpretation and conflict.

(a) In their interpretation and application, the provisions of this chapter shall be held to be the minimum requirements for the promotion of the public health, safety and general welfare.

(b) This chapter is not intended to interfere with, abrogate, or annul any other ordinance, rule or regulation, statute or other provision of law. Where any provision of this chapter imposes restrictions different from those imposed by any other provision of this chapter or any other ordinance, rule or regulation, or other provision of law, whichever provisions are more restrictive or impose higher standards shall control.

(c) This chapter is not intended to abrogate any easement, covenant or any other private agreement or restriction; provided, that where the provisions of this chapter are more restrictive or impose higher standards than such easement, covenant or other private agreement or restriction, the requirements of this chapter shall govern. Where the provisions of the easement, covenant or private agreement or restriction imposed duties and obligations more restrictive, or higher standards than the requirements of this chapter, and such private provisions are inconsistent with this chapter or determinations thereunder, then such private provisions shall be operative and supplemental to this chapter and determinations made under this chapter.

(Code 1961, § 35A-7)

Sec. 29-5. Amendments.

For the purpose of providing for the public health, safety and general welfare, the board of directors may amend the provisions of this chapter. The city department designated by the city manager has the responsibility for updating on a continuing basis the drainage manual.

(Code 1961, § 35A-9; Ord. No. 15,988, § 4, 12-18-90)

Sec. 29-6. Appeals.

Any person aggrieved by a decision of the public works department may appeal any order, requirement, decision or determination to the planning commission. The next step in the process would be to a court of competent jurisdiction in accordance with law.

(Code 1961, § 35A-10; Ord. No. 17,697, § 1a, 3-17-98)

Sec. 29-7. Disclaimer of liability.

The performance standards and design criteria set forth in this chapter and in the drainage manual establish minimum requirements which must be implemented with good engineering practice and workmanship. Use of the requirements contained herein shall not constitute a representation, guarantee or warranty of any kind by the city, or its officers and employees, of the adequacy or safety of any stormwater management structure or use of the land. The approval of the stormwater management and drainage plan does not imply that the land uses permitted will be free from damages caused by stormwater runoff. The degree of protection required by this chapter is considered reasonable for regulatory purposes and is based on historical records, engineering and scientific methods of study. Larger storms may occur or stormwater runoff heights may be increased by manmade or natural causes. This chapter, therefore, shall not create liability on the part of the city or any officer or employee with respect to any legislative or administrative decision lawfully made hereunder.

(Code 1961, § 35A-11)

Sec. 29-8. Enforcement generally.

(a) It shall be the duty of the public works department to bring to the attention of the city attorney any violation or lack of compliance herewith.

(b) The public works department shall be responsible for determining whether the stormwater management and drainage plan is in conformance with the requirements specified in the Stormwater Management and Drainage Manual. The public works department shall be responsible for determining whether the development plan is proceeding in accordance with the approved drainage plan. Periodic inspection of the development site shall be made by the public works departments to ensure that the stormwater management and drainage plan is properly implemented and that the improvements are maintained.

(Code 1961, §§ 35A-23, 35A-24; Ord. No. 17,697, § 1a, 3-17-98)

Sec. 29-9. Remedial work.

If it is determined through inspection that the development is not proceeding in accordance with the approved stormwater management and drainage plan, and drainage and/or building permit, the public works department shall immediately issue written notice to the permittee and the surety of the nature and location of the alleged noncompliance, accompanied by documentary evidence demonstrating noncompliance and specifying what remedial work is necessary to bring the project into compliance. The permittee so notified shall immediately, unless weather conditions or other factors beyond the control of the permittee prevent immediate remedial action, commence the recommended remedial action and shall complete the remedial work within seventy-two (72) hours or within a reasonable time as determined in advance by the public works department. Upon satisfactory completion of remedial work, the public works department shall issue a notice of compliance and the development may proceed.

(Code 1961, § 35A-25; Ord. No. 17,697, § 1a, 3-17-98)

Sec. 29-10. Revocation of permits or approvals; stop orders.

The public works department after giving five (5) days' written notice may revoke the permit issued for any project which is found upon inspection to be in violation of the provisions of this chapter, and for which the permittee has not agreed to undertake remedial work as provided in section 29-9. Drainage and/or building permits may also be revoked if remedial work is not completed within the time allowed. Upon revocation of a permit or approval, the public works department shall issue a stop work order. Such stop work order shall be directed to the permittee and he shall immediately notify persons owning the land, the developer and those persons actually performing the physical work of clearing, grading and developing the land. The stop work order shall direct the parties involved to cease and desist all or any portion of the work on the development or a portion thereof which is not in compliance, except such remedial work necessary to bring the project into compliance.

(Code 1961, § 35A-26; Ord. No. 17,697, § 1a, 3-17-98)

Sec. 29-11. Modifications to stormwater management and drainage manual.

Any modifications to the stormwater management and drainage manual will be made by the public works department. Modifications must be consistent with stated policies and the intent of this chapter.

(Code 1961, § 35A-6; Ord. No. 17,697, § 1a, 3-17-98)

Secs. 29-12--29-35. Reserved.

ARTICLE II. STORMWATER MANAGEMENT AND DRAINAGE SYSTEM

Sec. 29-36. Generally.

This article establishes the stormwater runoff management system of the city which shall be composed of a major system and a minor system, management controls and management practices. This article shall apply in the minor system.

(Code 1961, § 35A-40)

Sec. 29-37. Major system.

The major system is the area in any drainageway within the limits of flow of a one-hundred-year storm.

(Code 1961, § 35A-41)

Sec. 29-38. Minor system.

The minor system shall be composed of all watercourses and drainage structures, both public and private, that are not part of the major system, because of lower design storm frequencies.

(Code 1961, § 35A-42)

Sec. 29-39. Management controls.

Management controls are requirements applicable to the major system under the provisions of this chapter. Such controls shall limit any activity which adversely affect hydraulic function of open channels, drainage swales, detention facilities or enclosed stormwater conveyance systems. The drainage manual shall be the official document used for designing stormwater management controls and drainage systems.

(Code 1961, § 35A-43)

Sec. 29-40. Management practices.

The following practices may be used on approval by the public works department.

- (1) *Storage.* Runoff may be stored in temporary or permanent detention basins, or through rooftop, parking lot ponding, or percolation storage, or by other means in accordance with the design criteria and performance standards set forth in this chapter.
- (2) *Open channels.* Maximum feasible use shall be made of existing drainageways, open channels and drainage swales that are designed and coordinated with the design of building lots and streets in accordance with the design criteria and performance standards set forth in the drainage manual.
- (3) *Curbs.* Streets, curbs and gutters shall be an integral part of the stormwater runoff management system. To the maximum extent possible, drainage systems, street layout and grades, lotting patterns and the location of curbs, inlets and site drainage and overflow swales shall be concurrently designed in accordance with design criteria and performance standards set forth in the drainage manual.
- (4) *Enclosed conveyance systems.* Enclosed conveyance systems consisting of inlets, conduits and manholes may be used to convey stormwater runoff. Where used, such systems must be designed and performance standards set forth in the drainage manual.
- (5) *Other practices.* The stormwater runoff management practices enumerated herein shall not

constitute an exclusive listing of available management practices. Other generally accepted practices and methods may be approved by the public works department, if the purposes, design criteria and minimum performance standards of this chapter are complied with.

(Code 1961, § 35A-44; Ord. No. 17,697, § 1a, b, 3-17-98)

Sec. 29-41. Public responsibilities.

Administration of this chapter shall be the responsibility of the public works department, who shall review to determine approval, disapproval or modification of stormwater management plans as provided herein. The city department designated by the city manager shall be responsible after construction for the operation and maintenance of all drainage structures and improved courses which are part of the stormwater runoff management system under public ownership and which are not constructed and maintained by or under the jurisdiction of any state or federal agency.

(Code 1961, § 35A-45(a); Ord. No. 15,988, § 4, 12-18-90; Ord. No. 17,697, § 1a, 3-17-98)

Sec. 29-42. Private responsibilities.

(a) Each developer of land within the city has a responsibility to provide on the developer's property all approved stormwater runoff management facilities to ensure the adequate drainage and control of stormwater on the developer's property both during and after construction of such facilities.

(b) Each developer or owner has a responsibility and duty before and after construction to properly operate and maintain any on-site stormwater runoff control facility which has not been accepted for maintenance by the public. Such responsibility is to be transmitted to subsequent owners through appropriate covenants.

(Code 1961, § 35A-45(b))

Sec. 29-43. Unpermitted discharges of dry and wet weather overflows from sanitary sewers into the city's municipal separate storm sewer system.

The operator of the Little Rock Sanitary Sewer System shall eliminate unpermitted discharges of dry and wet weather overflows from sanitary sewers into the city's municipal separate storm sewer system.

(Ord. No. 19,497, § 1, 3-7-06)

Sec. 29-44. Infiltration from sanitary sewers into the city's municipal separate storm sewer system

The operator of the Little Rock Sanitary Sewer System shall limit the infiltration from sanitary sewers into the city's municipal separate storm sewer system.

(Ord. No. 19,497, § 2, 3-7-06)

Sec. 29-45. Discharge of nonstormwater to the city's municipal separate storm sewer system.

(a) Except as provided in paragraph (b) below, it shall be unlawful to discharge nonstormwater to the city's municipal separate storm sewer system.

(b) Unless identified by the city, the U.S. Environmental Protection Agency, or the state as significant sources of pollutants to waters of the state, it shall not be unlawful to discharge the following nonstormwater into the city's municipal separate storm sewer system:

- (1) Water line flushing;
- (2) Landscape irrigation;
- (3) Diverted stream flows;
- (4) Rising ground waters;

- (5) Uncontaminated ground water infiltration [as defined at 40 CFR 35.2005(20)] to separate storm sewers;
- (6) Uncontaminated pumped ground water;
- (7) Discharges from potable water sources;
- (8) Foundation drains;
- (9) Air conditioning condensate;
- (10) Irrigation water;
- (11) Springs;
- (12) Water from crawl space pumps;
- (13) Footing drains;
- (14) Lawn watering;
- (15) Individual residential car washing;
- (16) Flows from riparian habitats and wetlands;
- (17) Dechlorinated swimming pool discharges;
- (18) Street wash waters; and
- (19) Discharges or flows from emergency firefighting activities.

(Ord. No. 19,497, § 3, 3-7-06)

Sec. 29-46. Discharge of used motor vehicle fluids and household hazardous wastes into the city's municipal separate storm sewer system.

It shall be unlawful to discharge used motor vehicle fluids and household hazardous wastes into the city's municipal separate storm sewer system.

(Ord. No. 19,497, § 1, 3-7-06)

Secs. 29-47--29-60. Reserved.

ARTICLE III. STORMWATER MANAGEMENT AND DRAINAGE PLANS

Sec. 29-61. Generally.

(a) Any person proposing to construct buildings or develop land within the city's planning jurisdiction shall submit drainage plans to the public works department for approval of a stormwater management and drainage plan before building permits are issued or subdivisions are approved. No land shall be developed except upon approval by the public works department.

Cross references: Planning area, § 23-2.

(b) All construction subdivision approvals or remodeling activities shall have a stormwater management and drainage plan approved before a building permit is issued or subdivision is approved except for the following:

- (1) One (1) new or existing single-family structure.
- (2) One (1) new or existing duplex family structure.
- (3) One (1) new commercial or industrial structure located on less than a one-acre individual lot.
- (4) One (1) existing commercial or industrial structure where additional structural improvements are less than five hundred (500) square feet.

(Code 1961, §§ 35A-3, 35A-4; Ord. No. 17,697, § 1a, 3-17-98)

Sec. 29-62. Preparation and approval.

The stormwater management and drainage plan shall be prepared by the engineer of record. No building permits or subdivision approvals shall be issued until and unless the stormwater management and drainage plan has been approved by the public works department.

(Code 1961, § 35A-55; Ord. No. 17,697, § 1a, 3-17-98)

Sec. 29-63. Pre-preliminary drainage plan review.

A pre-preliminary drainage plan review with the engineering staff is suggested before preliminary platting for the purpose of overall general drainage concept review.

(Code 1961, § 35A-56)

Sec. 29-64. Review of preliminary stormwater and drainage plan.

A preliminary stormwater and drainage plan, and accompanying information, shall be submitted at the time of preliminary plat submittal. If needed, a review meeting will be scheduled by the public works department with representatives of the developer, including the engineer of record, to review the overall concepts included in the preliminary stormwater and drainage plan. The purpose of this review shall be to jointly agree upon an overall stormwater management concept for the proposed development and to review criteria and design parameters which shall apply to final design of the project.

(Code 1961, § 35A-57; Ord. No. 17,697, § 1a, 3-17-98)

Sec. 29-65. Final stormwater management and drainage plan.

Following the preliminary stormwater management and drainage plan review, the final stormwater management and drainage plan shall be prepared for each phase of the proposed project as each phase is developed. The final plan shall constitute a refinement of the concepts approved in the preliminary stormwater and

drainage plan with preparation and submittal of detailed information as required in the drainage manual. This plan shall be submitted at the time construction drawings are submitted for approval. No final plat is to be approved until the drainage structures approved on the construction plans are in place and approved by the public works department.

(Code 1961, § 35A-58; Ord. No. 17,697, § 1a, 3-17-98)

Sec. 29-66. Review and approval of final stormwater management and drainage plans.

(a) Final stormwater management and drainage plans shall be reviewed by the public works department. If it is determined according to present engineering practice that the proposed development will provide control of stormwater runoff in accordance with the purposes, design criteria, and performance standards of this chapter and will not be detrimental to the public health, safety and general welfare, the public works department shall approve the plan or conditionally approve the plan, setting forth the conditions thereof.

(b) If it is determined that the proposed development will not control stormwater runoff in accordance with this chapter, the public works department shall disapprove the final stormwater management and drainage plan.

(c) If disapproved, the application and data shall be returned to the applicant for resubmittal.

(d) Time frames for filing, review and approval of stormwater management and drainage plans shall coincide with time periods applicable in chapter 31.

(Code 1961, § 35A-59; Ord. No. 17,697, § 1a, 3-17-98)

Secs. 29-67--29-85. Reserved.

ARTICLE III. STORMWATER MANAGEMENT AND DRAINAGE PLANS

Sec. 29-61. Generally.

(a) Any person proposing to construct buildings or develop land within the city's planning jurisdiction shall submit drainage plans to the public works department for approval of a stormwater management and drainage plan before building permits are issued or subdivisions are approved. No land shall be developed except upon approval by the public works department.

Cross references: Planning area, § 23-2.

(b) All construction subdivision approvals or remodeling activities shall have a stormwater management and drainage plan approved before a building permit is issued or subdivision is approved except for the following:

- (1) One (1) new or existing single-family structure.
- (2) One (1) new or existing duplex family structure.
- (3) One (1) new commercial or industrial structure located on less than a one-acre individual lot.
- (4) One (1) existing commercial or industrial structure where additional structural improvements are less than five hundred (500) square feet.

(Code 1961, §§ 35A-3, 35A-4; Ord. No. 17,697, § 1a, 3-17-98)

Sec. 29-62. Preparation and approval.

The stormwater management and drainage plan shall be prepared by the engineer of record. No building permits or subdivision approvals shall be issued until and unless the stormwater management and drainage plan has been approved by the public works department.

(Code 1961, § 35A-55; Ord. No. 17,697, § 1a, 3-17-98)

Sec. 29-63. Pre-preliminary drainage plan review.

A pre-preliminary drainage plan review with the engineering staff is suggested before preliminary platting for the purpose of overall general drainage concept review.

(Code 1961, § 35A-56)

Sec. 29-64. Review of preliminary stormwater and drainage plan.

A preliminary stormwater and drainage plan, and accompanying information, shall be submitted at the time of preliminary plat submittal. If needed, a review meeting will be scheduled by the public works department with representatives of the developer, including the engineer of record, to review the overall concepts included in the preliminary stormwater and drainage plan. The purpose of this review shall be to jointly agree upon an overall stormwater management concept for the proposed development and to review criteria and design parameters which shall apply to final design of the project.

(Code 1961, § 35A-57; Ord. No. 17,697, § 1a, 3-17-98)

Sec. 29-65. Final stormwater management and drainage plan.

Following the preliminary stormwater management and drainage plan review, the final stormwater management and drainage plan shall be prepared for each phase of the proposed project as each phase is developed. The final plan shall constitute a refinement of the concepts approved in the preliminary stormwater and

drainage plan with preparation and submittal of detailed information as required in the drainage manual. This plan shall be submitted at the time construction drawings are submitted for approval. No final plan is to be approved until the drainage structures approved on the construction plans are in place and approved by the public works department.

(Code 1961, § 35A-58; Ord. No. 17,697, § 1a, 3-17-98)

Sec. 29-66. Review and approval of final stormwater management and drainage plans.

(a) Final stormwater management and drainage plans shall be reviewed by the public works department. If it is determined according to present engineering practice that the proposed development will provide control of stormwater runoff in accordance with the purposes, design criteria, and performance standards of this chapter and will not be detrimental to the public health, safety and general welfare, the public works department shall approve the plan or conditionally approve the plan, setting forth the conditions thereof.

(b) If it is determined that the proposed development will not control stormwater runoff in accordance with this chapter, the public works department shall disapprove the final stormwater management and drainage plan.

(c) If disapproved, the application and data shall be returned to the applicant for resubmittal.

(d) Time frames for filing, review and approval of stormwater management and drainage plans shall coincide with time periods applicable in chapter 31.

(Code 1961, § 35A-59; Ord. No. 17,697, § 1a, 3-17-98)

Secs. 29-67--29-85. Reserved.

ARTICLE IV. DESIGN CRITERIA AND PERFORMANCE STANDARDS

DIVISION 1. GENERALLY

Secs. 29-86--29-95. Reserved.

DIVISION 2. DESIGN CRITERIA

Sec. 29-96. Generally.

The drainage manual shall be the accepted design document. Unless otherwise provided, the provisions of this division shall govern the design and improvements with respect to managing stormwater runoff.

(Code 1961, § 35A-70)

Sec. 29-97. Method of determining storm-water runoff.

(a) Developments where the upstream drainage area contributing runoff is less than two hundred (200) acres should be designed using the rational method of calculating runoff. Developments where the area contributing runoff is between two hundred (200) and two thousand (2,000) acres should be designed using the U.S. Soil Conservation Service's TR-55 method of calculating runoff. For developments where the area contributing runoff is greater than two thousand (2,000) square acres or more, the U.S. Army Corps of Engineers' HEC-I program should be used to calculate flows or discharges. The applicant may also submit an alternative hydrograph method of evaluation for the calculation of runoff to the public works department for review and approval.

(b) All such development proposals shall be prepared by a professional engineer licensed in the state.

(Code 1961, § 35A-70(a); Ord. No. 17,697, § 1a, 3-17-98)

Sec. 29-98. Development design.

Streets, lots, depths of lots, parks, and other public grounds shall be located and laid out in such a manner as to minimize the velocity of overland flow, allow maximum opportunity for infiltration of stormwater to the ground, and to preserve and utilize existing and planned streams, channels, extension basins, and include, wherever possible, streams and floodplains within parks and other public grounds.

(Code 1961, § 35A-70(b))

Sec. 29-99. Detention.

Developments also shall include temporary detention of stormwater runoff in order to minimize downstream flooding conditions. The following design criteria shall govern the design of temporary drainage facilities:

(1) *Storage volume.* The volume of storage provided in the detention basin shall be sufficient to control the differential runoff from the twenty-five-year storm frequency of six-hour duration. The differential runoff is the volume and rate of flow of stormwater runoff discharged from a parcel of land or drainage area which is or will be greater than the volume and rate which pertained prior to proposed development for redevelopment.

(2) *Freeboard.* Detention storage areas shall have adequate capacity to contain the storage volume of tributary stormwater runoff with at least six (6) inches of freeboard above the water surface of flow and the emergency spillway in a twenty-five-year storm. The entire structure should be designed for discharging the major storm.

(3) *Outlet control works.* Outlet works shall be designed to limit peak out-flow rates from detention storage areas to or below peak flow rates for a twenty-five-year storm that would have occurred prior to the proposed development. Outlet works shall not include any mechanical components or devices and shall function without requiring attendance or control during operation. Size and hydraulic characteristics shall be such that all water and detention storage is released to the downstream storm sewer systems within twenty-four (24) hours after the end of the design rainfall. Normal time for discharge ranges from three (3) to twenty-four (24) hours.

(4) *Spillway.* Emergency spillways shall be provided to permit the safe passage of runoff generated from a one-hundred-year storm or greater, if appropriate because of downstream high hazard, such as loss of life or damage to high-value property.

(5) *Design data submittal.* In addition to complete plans, all design data shall be submitted as required in the detention design data submittal section of the drainage manual.

(6) *Detention methods.* Depending upon the detention alternatives selected by the engineer of record, the design criteria for detention ponds shall follow those given in the drainage manual.

(Code 1961, § 35A-70(e))

Sec. 29-100. Reductions in coefficient of runoff.

If an existing site with an existing coefficient of runoff of 1.0 (totally impervious) is developed, no on-site detention or in-lieu fee for detention is required. Also, if an existing site is developed whereby the coefficient of runoff is reduced to a lesser value, no on-site detention or in-lieu fee is required.

(Code 1961, § 35A-70(f))

Sec. 29-101. Enclosed systems and open channels.

Enclosed systems and open channels shall be designed using the design drainage manual.

(Code 1961, § 35A-70(c))

Sec. 29-102. Evaluation of downstream flooding.

The engineer of record should evaluate whether the proposed plan will cause or increase downstream flooding conditions. This evaluation should be made on the basis of existing downstream development and an analysis of stormwater runoff with and without the proposed development. When it is determined that the proposed development will cause or increase downstream flooding conditions, provisions to minimize such flooding conditions should be included in the design of storm management improvements. Such provisions may include downstream improvements and/or detention of stormwater runoff and its regulated discharge to the downstream storm drainage system.

(Code 1961, § 35A-70(d))

Sec. 29-103. Alternatives to on-site detention.

Alternatives to on-site detention are as follows:

(1) *Generally.* Where on-site detention is deemed inappropriate due to local topographical or other physical conditions, alternate methods for accommodating increases in stormwater runoff shall be permitted. The methods may include:

- a. Off-site detention or comparable improvements.
- b. In-lieu monetary contributions for channel improvements or off-site detention improvements

by the city within the same watershed. Channel improvements shall only be used if they are an integral part of a detailed watershed study.

(2) *In-lieu contributions to regional or subregional detention.* An owner may contribute to the construction of a regional or subregional detention site constructed or to be constructed in lieu of constructing on-site detention. However, no in-lieu contributions are allowed when existing flooding occurs downstream from the development, or if the development will cause downstream flooding.

(3) *In-lieu fees.* The in-lieu fee contribution shall be based upon an amount of ten thousand dollars (\$10,000.00) per acre-foot of stormwater storage.

(4) *Excess stormwater storage credit.* An owner may receive credit for excess stormwater storage (in acre-feet) created on one (1) site that may be applied to another site within the same watershed. The transfer of storage volume credit (in acre-feet) shall not be allowed if the site where credited storage is proposed to be transferred has an existing flooding condition downstream or the proposed development will produce downstream flooding.

(5) *Regional or subregional detention sites.* The acquisition of regional or subregional detention sites and construction of facilities thereon will be financed by the city. Monies contributed by the owners as above provided shall be used for regional and subregional detention site studies, land acquisition and facility construction thereof in the watershed in which the development is located.

(6) *Watershed boundaries.* The boundaries of watersheds and priority of acquisition of regional and subregional detention sites in construction of detention facilities and location thereof shall be established by the public works department and approved by the planning commission.

(Code 1961, § 35A-70(g); Ord. No. 17,697, § 1a, 3-17-98)

Secs. 29-104--29-125. Reserved.

DIVISION 3. PERFORMANCE STANDARDS

Sec. 29-126. Stormwater channel location.

Generally acceptable locations of stormwater runoff channels in the design of a subdivision may include, but not be limited to, the following:

- (1) In a depressed median of a double roadway, street or parkway provided the median is wide enough to permit maximum three (3) to one (1) side slopes.
- (2) Along the roadway, street or parkway.
- (3) Located along lot lines or entirely within the rear yards of a single row of lots or parcels.
- (4) In each of the foregoing cases, a drainage easement to facilitate maintenance and design flow shall be provided and shown on the plat. Drainage easement required dimensions are shown in the drainage manual and shall conform to the dimensions given. No structures shall be constructed within or across stormwater channels without the approval of the public works department.

Sec. 29-127. Easements.

(a) Drainage easements required to facilitate maintenance, detention and conveyance of stormwater shall be provided and shown on the preliminary and final plat. There are two (2) types of easements that are to be determined by the engineer of record and shown on the preliminary final plat. These are:

- (1) *Minor storm easements.* Easements designed to carry the minor storm (ten-year design frequency). The minor storm easements are primarily for carrying flow from the ten-year storm, maintenance access, utility locations, and are to be kept clear of any obstructions.
- (2) *Major storm easements.* Privately maintained easements designed to carry the major storm (one-hundred-year design frequency). The major storm easements shall be kept free of obstructions, such as fill or fences, that would impede the flow of the one-hundred-year design storm. Properly designed

landscaping that does not impede the flow of floodwater or endanger adjacent property is acceptable.

(b) Drainage easements shall be dedicated to the city when required or approved by the public works department.

(Code 1961, §§ 35A-6, 35A-71(b); Ord. No. 17,697, § 1a, 3-17-98)

Sec. 29-128. Storm sewer outfall.

The storm sewer outfall shall be designed so as to provide adequate protection against downstream erosion and scouring.

(Code 1961, § 35A-71(c))

Sec. 29-129. Lot lines.

Whenever the plans call for the passage and/or storage of floodwater, surface runoff or stormwater along lot lines involving the major storm system, grading of all such lots shall be prescribed and established for the passage and/or storage of waters. No structure may be erected which will obstruct the flow of stormwater, no fences, shrubbery, or trees planted, or changes made to the prescribed grades and contours of the specified floodwater or stormwater runoff channels.

(Code 1961, § 35A-71(d))

Sec. 29-130. Manholes.

All sanitary sewer manholes constructed in a floodplain or in an area designed for the storage or passage of flood or stormwater shall be provided with either a watertight manhole cover or be constructed with a rim elevation of a minimum one (1) foot above the high water elevation of the base flood, whichever is applicable to the specific area.

(Code 1961, § 35A-71(e))

Sec. 29-131. Floor elevations.

The floor elevation of any occupied residence or commercial building shall be a minimum of twelve (12) inches above the land immediately surrounding the building. The minimum floor elevation for a structure located on the uphill side of a street shall be at or above the crown of the adjacent street.

(Code 1961, § 35A-71(f))

Secs. 29-132--29-145. Reserved.

ARTICLE IV. DESIGN CRITERIA AND PERFORMANCE STANDARDS

DIVISION 1. GENERALLY

Secs. 29-86--29-95. Reserved.

DIVISION 2. DESIGN CRITERIA

Sec. 29-96. Generally.

The drainage manual shall be the accepted design document. Unless otherwise provided, the provisions of this division shall govern the design and improvements with respect to managing stormwater runoff.

(Code 1961, § 35A-70)

Sec. 29-97. Method of determining stormwater runoff.

(a) Developments where the upstream drainage area contributing runoff is less than two hundred (200) acres should be designed using the rational method of calculating runoff. Developments where the area contributing runoff is between two hundred (200) and two thousand (2,000) acres should be designed using the U.S. Soil Conservation Service's TR-55 method of calculating runoff. For developments where the area contributing runoff is greater than two thousand (2,000) square acres or more, the U.S. Army Corps of Engineers' HEC-I program should be used to calculate flows or discharges. The applicant may also submit an alternative hydrograph method of evaluation for the calculation of runoff to the public works department for review and approval.

(b) All such development proposals shall be prepared by a professional engineer licensed in the state.

(Code 1961, § 35A-70(a); Ord. No. 17,697, § 1a, 3-17-98)

Sec. 29-98. Development design.

Streets, lots, depths of lots, parks, and other public grounds shall be located and laid out in such a manner as to minimize the velocity of overland flow, allow maximum opportunity for infiltration of stormwater to the ground, and to preserve and utilize existing and planned streams, channels, extension basins, and include, wherever possible, streams and floodplains within parks and other public grounds.

(Code 1961, § 35A-70(b))

Sec. 29-99. Detention.

Developments also shall include temporary detention of stormwater runoff in order to minimize downstream flooding conditions. The following design criteria shall govern the design of temporary drainage facilities:

(1) *Storage volume.* The volume of storage provided in the detention basin shall be sufficient to control the differential runoff from the twenty-five-year storm frequency of six-hour duration. The differential runoff is the volume and rate of flow of stormwater runoff discharged from a parcel of land or drainage area which is or will be greater than the volume and rate which pertained prior to proposed development for redevelopment.

(2) *Freeboard.* Detention storage areas shall have adequate capacity to contain the storage volume of tributary stormwater runoff with at least six (6) inches of freeboard above the water surface of flow and the emergency spillway in a twenty-five-year storm. The entire structure should be designed for discharging the major storm.

(3) *Outlet control works.* Outlet works shall be designed to limit peak out-flow rates from detention storage areas to or below peak flow rates for a twenty-five-year storm that would have occurred prior to the proposed development. Outlet works shall not include any mechanical components or devices and shall function without requiring attendance or control during operation. Size and hydraulic characteristics shall be such that all water and detention storage is released to the downstream storm sewer systems within twenty-four (24) hours after the end of the design rainfall. Normal time for discharge ranges from three (3) to twenty-four (24) hours.

(4) *Spillway.* Emergency spillways shall be provided to permit the safe passage of runoff generated from a one-hundred-year storm or greater, if appropriate because of downstream high hazard, such as loss of life or damage to high-value property.

(5) *Design data submittal.* In addition to complete plans, all design data shall be submitted as required in the detention design data submittal section of the drainage manual.

(6) *Detention methods.* Depending upon the detention alternatives selected by the engineer of record, the design criteria for detention ponds shall follow those given in the drainage manual.

(Code 1961, § 35A-70(e))

Sec. 29-100. Reductions in coefficient of runoff.

If an existing site with an existing coefficient of runoff of 1.0 (totally impervious) is developed, no on-site detention or in-lieu fee for detention is required. Also, if an existing site is developed whereby the coefficient of runoff is reduced to a lesser value, no on-site detention or in-lieu fee is required.

(Code 1961, § 35A-70(f))

Sec. 29-101. Enclosed systems and open channels.

Enclosed systems and open channels shall be designed using the design drainage manual.

(Code 1961, § 35A-70(c))

Sec. 29-102. Evaluation of downstream flooding.

The engineer of record should evaluate whether the proposed plan will cause or increase downstream flooding conditions. This evaluation should be made on the basis of existing downstream development and an analysis of stormwater runoff with and without the proposed development. When it is determined that the proposed development will cause or increase downstream flooding conditions, provisions to minimize such flooding conditions should be included in the design of storm management improvements. Such provisions may include downstream improvements and/or detention of stormwater runoff and its regulated discharge to the downstream storm drainage system.

(Code 1961, § 35A-70(d))

Sec. 29-103. Alternatives to on-site detention.

Alternatives to on-site detention are as follows:

(1) *Generally.* Where on-site detention is deemed inappropriate due to local topographical or other physical conditions, alternate methods for accommodating increases in stormwater runoff shall be permitted. The methods may include:

- a. Off-site detention or comparable improvements.
- b. In-lieu monetary contributions for channel improvements or off-site detention improvements

by the city within the same watershed. Channel improvements shall only be used if they are an integral part of a detailed watershed study.

(2) *In-lieu contributions to regional or subregional detention.* An owner may contribute to the construction of a regional or subregional detention site constructed or to be constructed in lieu of constructing on-site detention. However, no in-lieu contributions are allowed when existing flooding occurs downstream from the development, or if the development will cause downstream flooding.

(3) *In-lieu fees.* The in-lieu fee contribution shall be based upon an amount of ten thousand dollars (\$10,000.00) per acre-foot of stormwater storage.

(4) *Excess stormwater storage credit.* An owner may receive credit for excess stormwater storage (in acre-feet) created on one (1) site that may be applied to another site within the same watershed. The transfer of storage volume credit (in acre-feet) shall not be allowed if the site where credited storage is proposed to be transferred has an existing flooding condition downstream or the proposed development will produce downstream flooding.

(5) *Regional or subregional detention sites.* The acquisition of regional or subregional detention sites and construction of facilities thereon will be financed by the city. Monies contributed by the owners as above provided shall be used for regional and subregional detention site studies, land acquisition and facility construction thereof in the watershed in which the development is located.

(6) *Watershed boundaries.* The boundaries of watersheds and priority of acquisition of regional and subregional detention sites in construction of detention facilities and location thereof shall be established by the public works department and approved by the planning commission.

(Code 1961, § 35A-70(g); Ord. No. 17,697, § 1a, 3-17-98)

Secs. 29-104--29-125. Reserved.

DIVISION 3. PERFORMANCE STANDARDS

Sec. 29-126. Stormwater channel location.

Generally acceptable locations of stormwater runoff channels in the design of a subdivision may include, but not be limited to, the following:

- (1) In a depressed median of a double roadway, street or parkway provided the median is wide enough to permit maximum three (3) to one (1) side slopes.
- (2) Along the roadway, street or parkway.
- (3) Located along lot lines or entirely within the rear yards of a single row of lots or parcels.
- (4) In each of the foregoing cases, a drainage easement to facilitate maintenance and design flow shall be provided and shown on the plat. Drainage easement required dimensions are shown in the drainage manual and shall conform to the dimensions given. No structures shall be constructed within or across stormwater channels without the approval of the public works department.

Sec. 29-127. Easements.

(a) Drainage easements required to facilitate maintenance, detention and conveyance of stormwater shall be provided and shown on the preliminary and final plat. There are two (2) types of easements that are to be determined by the engineer of record and shown on the preliminary final plat. These are:

- (1) *Minor storm easements.* Easements designed to carry the minor storm (ten-year design frequency). The minor storm easements are primarily for carrying flow from the ten-year storm, maintenance access, utility locations, and are to be kept clear of any obstructions.
- (2) *Major storm easements.* Privately maintained easements designed to carry the major storm (one-hundred-year design frequency). The major storm easements shall be kept free of obstructions, such as fill or fences, that would impede the flow of the one-hundred-year design storm. Properly designed

landscaping that does not impede the flow of floodwater or endanger adjacent property is acceptable.

(b) Drainage easements shall be dedicated to the city when required or approved by the public works department.

(Code 1961, §§ 35A-6, 35A-71(b); Ord. No. 17,697, § 1a, 3-17-98)

Sec. 29-128. Storm sewer outfall.

The storm sewer outfall shall be designed so as to provide adequate protection against downstream erosion and scouring.

(Code 1961, § 35A-71(c))

Sec. 29-129. Lot lines.

Whenever the plans call for the passage and/or storage of floodwater, surface runoff or stormwater along lot lines involving the major storm system, grading of all such lots shall be prescribed and established for the passage and/or storage of waters. No structure may be erected which will obstruct the flow of stormwater, no fences, shrubbery, or trees planted, or changes made to the prescribed grades and contours of the specified floodwater or stormwater runoff channels.

(Code 1961, § 35A-71(d))

Sec. 29-130. Manholes.

All sanitary sewer manholes constructed in a floodplain or in an area designed for the storage or passage of flood or stormwater shall be provided with either a watertight manhole cover or be constructed with a rim elevation of a minimum one (1) foot above the high water elevation of the base flood, whichever is applicable to the specific area.

(Code 1961, § 35A-71(e))

Sec. 29-131. Floor elevations.

The floor elevation of any occupied residence or commercial building shall be a minimum of twelve (12) inches above the land immediately surrounding the building. The minimum floor elevation for a structure located on the uphill side of a street shall be at or above the crown of the adjacent street.

(Code 1961, § 35A-71(f))

Secs. 29-132--29-145. Reserved.

**ARTICLE V. BONDS, MAINTENANCE
ASSURANCES AND DRAINAGE
APPROVALS**

Sec. 29-146. Maintenance agreement.

- (a) A maintenance agreement, approved by the public works department, assuring perpetual maintenance of stormwater management improvements shall be agreed upon by the city and the applicant.
- (b) Maintenance of detention ponds (wet type) shall be the responsibility of the owner of record and/or the property owners' association.
- (c) Maintenance of detention basins (dry type) shall be the responsibility of the owner of record and/or property owners' association. The city shall have the primary right to remove sediment when the basin's function is impaired. The owner of record and/or property owners' association shall be responsible for all other maintenance, plantings, reseeding or resodding. The owner shall also be responsible for removing and replacing any landscaping, playground equipment or other facilities within the basin.

(Code 1961, § 35A-80; Ord. No. 17,697, § 1a, 3-17-98)

Sec. 29-147. Maintenance bond.

A one-year maintenance bond against defects in workmanship shall be required by the public works department for any portion of the stormwater management improvements dedicated to the public.

(Code 1961, § 35A-81; Ord. No. 17,697, § 1a, 3-17-98)

Sec. 29-148. Drainage permits and/or approvals.

Upon approval of the final stormwater management and drainage plan, and acceptance and the applicant's assurances of performance and maintenance as provided in this chapter, the public works department shall approve the plan. Project approval shall be issued in the name of the applicant who shall then be known and thereafter be referred to as the permittee. An approved permit shall set forth the terms and conditions of the approved stormwater management and drainage plan.

(Code 1961, § 35A-82; Ord. No. 17,697, § 1a, 3-17-98)

Sec. 29-149. Engineer of record.

Should the original engineer of record be prevented from completing the project, the permittee shall employ another qualified engineer and notify the public works department immediately.

(Code 1961, § 35A-83; Ord. No. 17,697, § 1a, 3-17-98)

Secs. 29-150--29-165. Reserved.

ARTICLE VI. LAND ALTERATION REGULATIONS*

***Editor's note:** Ord. No. 19,353, § 2, adopted July 19, 2005, amended Art. VI in its entirety and enacted similar provisions as set out herein. The former Art. VI derived from Ord. No. 18,361, § 2, adopted Sept. 26, 2000.

State law references: Buffers and screening, § 36-520 et seq.

DIVISION 1. GENERALLY

Sec. 29-166. Penalty.

Any person convicted of a violation of any of the provisions of this chapter shall be punished as provided in section 1-9.

(Ord. No. 19,353, § 2, 7-19-05)

Sec. 29-167. Findings.

The city has experienced development activity causing the displacement of large amounts of earth and tree cover. Significant problems resulting from such development include flooding, soil erosion and sedimentation, unstable slopes, and impaired quality of life. These problems are a concern because of their negative effects on the safety and general welfare of the community.

(Ord. No. 19,353, § 2, 7-19-05)

Sec. 29-168. Purpose.

The purposes of this chapter are to:

- (1) Prohibit the indiscriminate clearing of property.
- (2) Prevent excessive grading, clearing, filling, cutting or similar activities.
- (3) Substantially reduce flooding, erosion and sediment damage within the city.
- (5) Safeguard the safety and welfare of citizens.
- (6) Establish reasonable standards and procedures for development which prevent potential flooding, erosion and sediment damage.
- (7) Prevent the pollution of streams, ponds and other watercourses by sediment.
- (8) Minimize the danger of flood loss and property loss due to unstable slopes.
- (9) Preserve natural vegetation which enhances the quality of life of the community.
- (10) To conceal hillside scars.
- (11) To preserve the contours of the natural landscape and land forms.

(Ord. No. 19,353, § 2, 7-19-05)

Sec. 29-169. General requirements.

Persons engaged in land alteration activities regulated by this chapter shall take measures to protect

neighboring public and private properties from damage by such activities. The requirements of this chapter, however, are not intended to prevent the reasonable use of properties as permitted by chapter 36 of this Code.

(Ord. No. 19,353, § 2, 7-19-05)

Sec. 29-170. Violation, enforcement and penalties.

(a) Violations of any provisions of this chapter shall be punishable as provided in section 1-9 of this Code, except that the continuing violation provisions of subsection 1-9(c) shall not apply unless:

(1) An approved plan for correction of the violation(s) has not been implemented by the responsible party within the time specified in the plan, or

(2) The responsible party fails to submit a required plan within the time specified.

(b) The responsible party shall be liable for all fines levied and remedial action required under this chapter. Each tree removed or improperly preserved or any other activity proscribed by this chapter shall be a separate violation. Each violation shall be considered a separate offense.

(c) Any person who engages in land alteration activities regulated by this chapter without obtaining a grading permit shall be required to restore the land to the maximum extent practicable to its original condition in accordance with section 29-196.

(d) When a violation of this chapter is determined to exist, the city official shall issue written notice of violation to the responsible party. The notice shall specify those sections of this chapter which are determined to be violated and shall include the time and conditions under which the violation(s) shall be corrected. If it is determined that the restoration is not feasible due to imminent construction, (1) a citation may be issued and fines may be levied; (2) the site shall be graded to obtain positive drainage; and (3) the site shall be stabilized with vegetation and the addition of erosion controls. If the responsible party has been issued either a notice of violation or stop work order within the previous twelve-month period, the notice may require the violation(s) to be corrected within twenty-four (24) hours.

(e) The responsible party shall have a maximum of ten (10) calendar days from the date of the written notice to appeal the finding of the violation(s) to the planning commission as provided in section 29-172.

(f) If the responsible party fails to comply with the written notice of violation the city official may issue a stop-work order and citation, as provided in section 29-10 and revoke all permits including the grading permit, building permit, and certificate of occupancy. Additionally, when the city official determines that trees to be protected are in the process of being removed or damaged or other emergencies exist, a stop work order to immediately cease and desist may be issued.

(g) The permit applicant shall have on the project site at all times an agent who is a competent superintendent capable of reading and thoroughly understanding the plans, specifications and requirements for areas of tree protection for the type of work being performed. The superintendent shall have full authority to issue orders or direction to employees working on site, without delay and to promptly supply such materials, labor, equipment, tools, and incidentals as may be required to complete the work in a proper manner. If no superintendent is on site, the city official may issue the notice of violation and stop work order to the person conducting the violation.

(h) Removal of trees with a diameter of six (6) inches or greater measured four and one-half (4.5) feet above the ground that have been removed without a grading permit or trees required in an approved plan that have been removed or which die shall be considered a violation.

(i) If a land alteration activity causes damage to off-site property or water, the responsible party shall be required to mitigate the damage and install such additional erosion controls, as approved by the city official, to prevent further damage.

(j) Damage to private or public property due to hauling operations or operation of construction related equipment from a nearby construction site shall be repaired by the responsible party prior to issuance of a certificate of occupancy.

(Ord. No. 19,353, § 2, 7-19-05)

Sec. 29-171. Conflicts.

Where provisions of this chapter conflict with any other ordinance, regulation, or resolution of the city, the most stringent provision shall be enforced. The provisions of this chapter are considered minimum requirements.

(Ord. No. 19,353, § 2, 7-19-05)

Sec. 29-172. Hearing before planning commission.

Appeals of a notice of violation as provided for in subsection 29-170(e), a grading and drainage plan decision, or a restoration plan requirement as provided in section 29-196 shall be heard by the planning commission provided an appeal is filed by the applicant within ten (10) calendar days after the date of the notice of violation, fee(s) are paid, and proper public notice is given. Any hearing before the planning commission regarding such appeal will be conducted in the following manner:

(a) The appellant shall submit an application and fee as provided in section 29-193 to the director of public works within the time limits provided for in subsection 29-170(e). The appellant shall provide (1) a cover letter that clearly sets forth the provisions of the article that are being appealed and (2) a copy of all pertinent graphic materials or correspondence. Appealable issues are as follows:

1. For a notice of violation, appealable issues are the determination that a violation has occurred, the time frame for correcting the violation, and the corrective action to be required.
2. For a grading and drainage plan decision, appealable issues are the denial of a grading permit and the terms of a grading permit.
3. For a restoration plan, appealable issues are any requirements of section 29-196.

(b) Certified-mail notice of all appeals shall be given by the applicant to adjacent property owners, including those across a street or alley from the subject property, at least ten (10) days prior to the planning commission meeting at which the appeal is to be considered. At least three (3) business days prior to the hearing, the appellant shall provide proof of notice to the director of public works. Failure to provide the required notice will cause the appeal to the planning commission to be dismissed, although minor irregularities in the giving of notice may be waived by the commission.

(c) At the conclusion of questioning and statements, the chairman will call the appeal to a vote as follows:

1. For an appeal of the finding of a violation, either to affirm or overturn the finding of violation; upon affirmation of a finding of violation, a citation may be issued to the appellant;
2. For an appeal of the time to correct the violation, either to affirm the time or determine a new time;
3. For an appeal of the corrective action, either to affirm, determine a new corrective action, or decide that a corrective action is not feasible. A finding that a corrective action is not feasible or appellant's refusal to comply with the commission's decision may result in a citation being issued to the appellant.
4. For an appeal of a grading and drainage plan decision, either affirm or overturn the decision to deny a grading permit, either affirm the permit term or establish a new permit term.
5. For an appeal of a restoration plan or plan provision, either to affirm, determine a new provision or provisions, or decide that restoration is not feasible. A citation may be issued after finding that restoration is not feasible or upon appellant's refusal to fully comply with the restoration measures required by the planning commission.

(d) Decisions by the commission shall be final and are not appealable to the city board of directors.

(Ord. No. 19,353, § 2, 7-19-05)

Secs. 29-173--29-185. Reserved.

DIVISION 2. GRADING PERMIT AND GRADING AND DRAINAGE PLAN

Sec. 29-186. Grading permit required.

(a) Any person proposing to engage in clearing, filling, cutting, harvesting, quarrying, construction or similar activities regulated by this chapter shall apply by means of a grading permit application obtained from the city for a grading permit as specified in this chapter. The city shall have a maximum three (3) working days to review the grading permit application before a permit is issued. Grading permits shall not be issued while applications are incomplete. A landscape permit as required in chapter 15 shall be obtained from the city before constructing or expanding a vehicular use area. Additionally, a permit is required when expanding or rehabilitating a building and landscaping is required under this chapter. Except as otherwise provided in chapter 15, the responsible party shall not allow the removal of more than seven (7) trees within any given twelve-month period without first obtaining a grading permit. No land shall be altered or cleared to the extent regulated in this chapter unless approved by a permit.

(b) No land alteration shall be permitted until all necessary city approval of all plans and permits, except building permit, have been issued and construction is imminent. Clearing and grading for streets and drainage improvements may be done on residential subdivisions provided the preliminary plat has been approved. In those cases where filling or cutting in areas with seven (7) or fewer trees is to be done, the area is to be graded suitable for mowing and shall be revegetated within twenty-one (21) calendar days of grading completion. If building construction has not commenced and been diligently pursued within eight (8) months of grading permit issuance, then all disturbed areas must be restored in accordance with section 29-196 and landscaping and tree requirements in the buffers shall be installed, unless the city official determines that the existing buffers on the site meet the landscape planting requirements of chapter 15 and zoning requirements of chapter 36 of this Code.

(c) A grading permit is required for land alteration activities specified in this section. All construction work shall include appropriate drainage and erosion control measures to protect neighboring properties. All land alteration on properties within the designated floodplain requires a grading permit without exception.

(d) Grading permits, which may be obtained as part of a building permit, shall be required for any of the following activities:

- (1) A top of hill or hillside cuts or fills greater than ten (10) feet vertical.
- (2) Any construction activity where the total volume of cut or fill is equal to or greater than one thousand (1,000) cubic yards.
- (3) Clearing or cutting of trees on property in the city except for:
 - i. Those districts zoned agriculture and forestry (AF);
 - ii Mining (M); and
 - iii. Properties abutting on a collector street of two (2) acres or less zoned single- or two-family districts R1, R2, R3, R4, or R7A, and residentially zoned properties of five (5) acres or less fronting on a residential street.

(e) Prior to issuance of a grading permit, a grading and drainage plan shall be submitted to and approved by the city for activities specified in subsections (d)(1), (2) and (3).

(f) When the application is for a planned zoning district, conditional use permit, site plan review, subdivision, or multiple building site approval, a sketch grading and drainage plan shall be required in the application to the planning commission only if any of the activities specified in subsection (d) are involved.

(g) Utility organizations may obtain a one-time approval from the city for all routine tree trimming and installation, maintenance, replacement and repair of fence and sign posts, telephone poles and other kinds of posts or poles and overhead or underground electric, water, sewer, natural gas, telephone or cable facilities. The approval will include a utility organization and its contractors, agents or assigns and will be permanent in nature as long as the original approved procedures are followed. However, large-scale utility projects involving clearing of areas over twenty-five (25) feet in width shall not be authorized by one-time approval of all projects. In such cases, a separate grading permit must be obtained for each project.

(h) One-time approval may be obtained by public or private entities for the stockpiling of construction spoil material and concrete and asphalt rubble at particular locations for a limited time period, not to exceed six (6) months. Grading and replanting of grassed areas and trees is required upon removal of stockpile.

Sec. 29-187. Exemptions and variances.

(a) A grading permit shall not be required for:

(1) Construction on properties in the city (i) zoned agriculture and forestry (AF); (ii) properties abutting on a collector street of two (2) acres or less zoned single- or two-family districts R1, R2, R3, R4 or R7A, and residentially zoned property five (5) acres or less fronting on a residential street.

(2) Emergency work or repairs to protect health, safety and welfare of the public. Removal of damaged or diseased trees will be permitted by staff upon certification by the city forester of the condition of the trees sought to be removed; and

(3) Mining and mining operations because these activities are covered by the Arkansas Open Cut Land Reclamation Act [A.C.A. Section 15-57-301 as amended], which is regulated by the state Department of Environmental Quality.

(b) The planning commission may grant variances from the standards set forth in this article provided that a variance request is filed by the applicant, fee(s) are paid, and proper public notice is given. The applicant shall submit a variance request application and fee as provided in section 29-193 to the director of public works. As part of the application, the applicant shall provide:

(1) A cover letter that clearly sets forth the provisions of the code from which a variance is requested and

(2) A copy of all pertinent graphic materials or correspondence.

(c) Certified-mail notice of all variance requests shall be given by the applicant to adjacent property owners, including those across a street or alley from the subject property, at least ten (10) days prior to the planning commission meeting at which the variance is to be considered. At least three (3) business days prior to the hearing, the applicant shall provide proof of proper notice to the director of public works. Failure to provide the required notice will cause the variance request to the planning commission to be dismissed, although minor irregularities in the giving of notice may be waived by the commission.

(d) Appeals from the variance decision of the planning commission shall be filed with the appropriate court of jurisdiction within thirty (30) calendar days of the decision of the planning commission.

(e) Variances may be granted, to the extent that the change will not be contrary to the purposes set forth in section 29-168:

(1) To clear and grade a multilot or multiphase development where construction is not imminent on all phases of the development;

(2) To harvest timber on land not otherwise allowed under this section in accordance with a reasonable staff-approved forestry-management plan which is determined to be reasonable and prepared by a registered forester or certified arborist using best management practice guidelines for silviculture in urban areas, that complies with the purposes and requirements of this article; however, clear cutting or total harvests shall not be allowed;

(3) To exceed the cut, fill, and slope requirements of section 29-190;

(4) From the restoration requirements of section 29-196.

The planning commission may impose conditions on the approval of variances. Where variances are granted, applicants shall otherwise comply with all other provisions of the ordinance including, but not limited to, obtaining a grading permit prior to construction or tree removal, meeting the standards for grading, drainage, tree removal, maintaining buffer zones, erosion controls, and establishing of vegetative cover following grading activities.

Sec. 29-188. Contents of grading and drainage plans.

(a) The sketch grading and drainage plan shall identify the following:

- (1) Acreage of the proposed project.
- (2) Land areas to be disturbed.
- (3) Stages of grading showing the limits of sections to be graded and indicating the approximate order of development.
- (4) The height and slope of cuts and fills. Cross sections may be required every fifty (50) feet on property where the depth of excavation or fill exceeds ten (10) feet, showing original and final grades and will include visual aids to show how the final development, including planting, and landscaping will look.
- (5) Provisions for collecting and discharging surface water.
- (6) Erosion and sediment measures, including structural and vegetative measures for permanent slopes and bank stability.
- (7) Seal and signature of a registered engineer, architect, or landscape architect, qualified under state regulations to certify that the sketch grading and drainage plan complies with this chapter. However, plans for less than two (2) acres fronting on a collector street, or residentially zoned areas less than five (5) acres fronting on a residential street, where cuts or fills are not greater than ten (10) feet in height or where only tree clearing activities are to be undertaken, may be required by public works to be prepared by a contractor or the property owner.

(b) A final grading and drainage plan shall include the following information prior to issuance of grading and special flood hazard development permits:

- (1) Seal of a registered engineer, architect or landscape architect qualified under state regulations to certify that the grading and drainage plan complies with this chapter.
- (2) A vicinity drawing showing location of property lines, location and names of all existing or platted streets or other public ways within or immediately adjacent to the tract.
- (3) Location of all known existing sewers, water mains, culverts and underground utilities within the tract and immediately adjacent thereto; location of existing permanent buildings on or immediately adjacent to the site if right of entry can be obtained to locate the utilities.
- (4) Identification of rights-of-way or easements affecting the property.
- (5) Soil-loss calculations as estimated by the universal soil-loss equation. Allowable soil loss shall not exceed five (5) tons per acre per year. Examples of soil-loss calculations are contained in the city's stormwater management and drainage manual.
- (6) A plan of the site at a minimum scale of one (1) inch equals one hundred (100) feet.
- (7) Such other information required by city officials, including, but not limited to:
 - a. Address and telephone number of owner, permit applicant and the designated agent responsible for maintenance of erosion and sediment control measures.
 - b. The approximate location and width of existing and proposed streets.
 - c. The locations and dimensions of all proposed or existing lots.
 - d. The locations and dimensions of all parcels of land proposed to be set aside for parks, playgrounds, natural condition perimeters, public use, or for the use of property owners in the proposed development.
 - e. Existing and proposed topography at a maximum of five-foot contour intervals for steep terrain; two-foot contour intervals for ten (10) percent or less grade terrain.
 - f. An approximate timing schedule, indicating the anticipated starting and completion dates of the development; a timing schedule for the sequence of grading and application of erosion and sediment control measures.
 - g. Acreage of the proposed project.
 - h. Identification of unusual material or soils in land areas to be disturbed. If any surface indications of unusual materials or soils that would cause street or lot instability, such as nonvertical tree growth, old slides, seepage, or depressions in the soil are visible before

grading, they should be noted and accompanied by the engineer's, architect's, landscape architect's, or contractor's recommendation for correcting such problem areas.

i. Identification of suitable material to be used for fills shall be accomplished before actual filling begins. If there are any surface indications that local material is not suitable for fills, those areas to be filled with outside material should be identified and the type and source of the fill noted.

j. Specification of measures to control runoff, erosion and sedimentation during the process of construction, noting those areas where control of runoff will be required during construction and indicating what will be used, such as straw bales, sediment basins, silt dams, brush check dams, lateral hillside ditches, catch basins, etc.

k. Measures to protect neighboring built-up areas and city property during process of construction, noting work to be performed, such as cleaning existing ditches, storm culverts and catch basins or raising existing curbs in neighboring areas.

l. Provisions to stabilize soils and slopes after completion of streets, sewers and other improvements, noting on the grading plan when and where ground cover will be planted, also noting any other means to be used such as placement of reinforced turf, staked sod, stone embankments, and riprap or construction of retaining walls.

(8) The grading and drainage plan shall include areas of tree protection, erosion and sediment control provisions meeting standards established by the city in the stormwater management and drainage manual. Tree lines and individual trees may be required to be shown.

(Ord. No. 19,353, § 2, 7-19-05)

Sec. 29-189. Issuance procedure.

(a) The following procedure shall be implemented for the issuance of a grading permit.

(1) The city official shall approve, disapprove or recommend modification of the grading and drainage plan in writing within five (5) working days after the date of submittal of a complete application.

(2) Applications for which planning commission approval is required shall be placed on the next available planning commission agenda following city staff review. Sketch grading and drainage plans shall be reviewed by the city and a report prepared by the time of the applicable subdivision subcommittee meeting, if possible, but not later than the applicable planning commission meeting.

(3) Except for residential subdivision work, the approval of a sketch grading and drainage plan shall not eliminate the need to submit and have approved a final grading and drainage plan prior to issuance of a building permit or the initiation of land alteration activities.

(4) For residential subdivision work, only a sketch grading and drainage plan shall be required, and clearing and grading work may proceed upon approval of the preliminary plat and issuance of a grading permit. The sketch plan for residential subdivisions shall indicate how runoff, erosion, and sedimentation will be controlled.

(b) Upon approval of the final plan, the city shall issue a grading permit. A superintendent capable of understanding the plans and with authority to issue orders to employees performing the land alteration shall properly supervise the land alteration activities.

(c) The city official may issue a stop work order if, upon inspection, it is determined that the work is not progressing in accordance with the approved plan.

(d) Groups of trees and individual trees that are not to be removed or that can be preserved with reasonable effort in site design or are located within required undisturbed buffer areas shall be protected during construction by protective fencing. The buffer and any preservation areas shall not be used for material storage or for any other purpose. The fencing shall be placed and maintained by the owner until all exterior construction except landscaping has been completed. Individual trees or groups of trees to be preserved outside the buffer area shall be fenced at no less than seventy-five (75) percent of the area within the drip line of the critical root zone and shall be flagged with bright orange vinyl tape wrapped around the main trunk at a height of four (4) feet or more such that the tape is clearly visible to workers on foot or operating equipment.

(e) The city official may allow minor modifications of the plan to alleviate particular problems during the process of construction. In reviewing a request for modifications, the city official may require from the

applicant's engineer, architect, or landscape architect appropriate reports and data sufficient to make a decision on the request.

(f) Major changes to plans approved by the planning commission either in sketch or final form shall only be permitted by the planning commission. Examples of major changes are those that substantially increase the height of cuts or the area of clearing or grading, or substantially impact neighboring properties. More than twenty (20) percent increase in height, area or impact will normally be considered a major change. Examples of increased impact include reductions in buffer area, increased runoff onto adjacent properties, and increased site area that is visible from adjacent properties or public streets.

(Ord. No. 19,353, § 2, 7-19-05)

Sec. 29-190. Grading and drainage plan requirements.

Preparation of grading and drainage plans shall follow the stormwater management and drainage manual and shall be designed on the basis of the following considerations:

(1) A maximum of thirty (30) vertical feet of fill or excavation (such as three (3) ten-foot vertical terraces or two (2) fifteen-foot vertical terraces) is permitted, however additional development areas may be constructed a minimum of one hundred fifty (150) feet in width and at a slope of no more than eight (8) percent. The maximum of thirty (30) feet of fill or excavation may again be utilized.

a. The depth of fill or excavation shall be measured from the finish grade elevation to the original ground line elevation.

b. No more than two hundred (200) feet of terrace can be in a straight line and a minimum of a ten (10) feet curved section, jog, or offset is required for each additional two hundred (200) feet of terrace.

c. For excavations or fills constructed with slopes flatter than 3:1 (three horizontal to one vertical), terraces are not required nor is there a limit on the height of cut or fill. Planting requirements on these 3:1 slopes shall be the same as required for terraces and shall be spaced uniformly over the slope.

d. Cuts or fills shall be limited to ten (10) feet in height or to fifteen (15) feet if architectural stone is included to protect the vertical face. A series of smaller cuts or fills with terraces, preserving portions of natural vegetation and providing areas for planting, shall be used in situations where more than ten (10) feet of cut or fill is needed.

e. Terracing width shall be at a ratio of at least one (1) foot of horizontal terrace for every one (1) foot of vertical height, up to a maximum of ten (10) feet. Terraces shall be landscaped with dense evergreen plantings sufficient to screen the cut or fill slope. The terrace may be sloped to drain up to one (1) foot in ten (10) feet of width.

f. If the slope of the cut or fill is faced with an architectural stone wall, the terrace plantings shall be a minimum of two (2) rows of trees four (4) feet between the rows, staggered not more than twenty (20) feet on centers.

g. Shrubs and ground cover shall be required in accordance with chapter 15 of this Code.

h. Slopes steeper than 3:1 may be allowed for street improvements in the right-of-way due to rock outcropping or extreme slope intercepts if approved by the director of public works.

(2) Development shall be planned to fit topography, soils, geology, hydrology, and other existing site conditions.

(3) Provisions shall be made for safety against unstable slopes or slopes subject to erosion and deterioration. The city official may require certified geotechnical analysis for sliding and global stability safety. New cuts and fills forming channel banks may require permanent provisions for erosion control upon determination by the city official.

(4) Grading shall complement natural landforms.

(5) After grading, all paving, seeding, sodding, or mulching shall be performed in accordance with a reasonable schedule approved by the city official.

(6) Open areas not planned for immediate use shall be seeded or sodded. Soil which is exposed for

more than twenty-one (21) days with no construction activity shall be seeded, mulched or revegetated in accordance with this code.

(7) Areas not well suited to development, as evidenced by existing competent soils, geology, hydrology investigations and reports, should be allocated to open space and recreational uses.

(8) The potential for soil loss shall be minimized by retaining natural vegetation wherever possible.

(9) Appropriate provisions such as those in the stormwater management and drainage manual shall be used to accommodate stormwater runoff and soil loss occasioned by changed soil and surface conditions during and after development, including the use of vegetation and limitations on soil exposure. If staff determines upon visual inspection that excessive silt from the construction has migrated on or offsite, additional measures to reduce erosion may be required.

(10) Permanent improvements such as streets, storm sewers, curb and gutters, and other features for control of storm runoff shall be scheduled as soon as economically and physically feasible before removing vegetation cover from the area, so that large areas are not left bare and exposed for long periods of time beyond the capacity of temporary control measures.

(11) A temporary or permanent sediment basin, debris basin, desilting basin or silt trap shall be installed and maintained to substantially reduce sediment from water runoff upon determination by the city official. The volume of the sediment basin shall be three thousand six hundred (3,600) cubic feet per acre for property with average slope steeper than five (5) percent, or one thousand eight hundred (1,800) cubic feet per acre for property with an average slope five (5) percent or flatter. A properly sized sediment basin is required for each separate drainage area within the property being developed.

(12) Construction access shall be limited to locations as approved by the city official. Construction access points shall be paved in uniformly graded stone without fines for a minimum length of twenty (20) percent of the lot depth or fifty (50) feet, whichever is greater, up to a maximum of one hundred (100) feet to prevent tracking onto the city street.

(13) Appropriate provisions such as the addition of water or dust retardants shall be utilized to prevent excessive particulate matter from becoming airborne.

(14) A perimeter buffer strip shall be temporarily maintained around disturbed areas for erosion control purposes and shall be kept undisturbed except for reasonable access for maintenance. The width of the strip shall be six (6) percent of the lot width and depth. The minimum width shall be twenty-five (25) feet and the maximum shall be forty (40) feet. In no event shall these temporary strips be less than the width of the permanent buffers required for the development.

(15) A minimum strip twenty-five (25) feet wide, undisturbed except for reasonable access, shall be provided along each side of streams having a ten-year storm of greater than one hundred fifty (150) cubic feet per second. The twenty-five-foot strip shall be measured from the top of the bank. An exception to this requirement is allowed where the only work being done on the site is public street construction.

(16) Care shall be exercised to minimize the risk of damage from or to pedestrian and vehicular traffic in the vicinity of a cut or fill by placement of handrails, guardrails, fencing or landscaping.

(17) Additional landscape treatment shall be provided in accordance with chapter 15 of this Code.

(Ord. No. 19,353, § 2, 7-19-05)

Sec. 29-191. Unified plan and permit.

One (1) plan may be submitted incorporating all provisions for compliance with the applicable city zoning, landscaping, drainage detention, grading, clearing, filling, cutting, quarrying, and construction requirements.

(Ord. No. 19,353, § 2, 7-19-05)

Sec. 29-192. Reserved.

Sec. 29-193. Fees.

A fee for each grading permit shall be paid to the city as follows:

TABLE INSET:

Total Project Area	Fee
Less than 1/2 acre.....	\$60.00
1/2 to 1 acre.....	120.00
Greater than 1 acre.....	\$120.00 for first acre, \$60.00 for each additional acre, up to a maximum of ten acres, not to exceed \$660.00.

Fees for each grading permit will double if the grading permit is issued after a notice of violation(s) has been issued for violation(s) of the land alteration regulations that have occurred on the subject property.

A fee for each appeal and variance shall be paid to the city as follows:

Flat fee . . . \$50.00
plus \$5.00 per acre of the total project area
up to ten acres,
not to exceed \$100.00

(Ord. No. 19,353, § 2, 7-19-05)

Sec. 29-194. Inspection and compliance.

- (a) The department designated by the city manager shall be responsible for determining whether construction is proceeding according to the approved grading and drainage plan.
- (b) City officials shall perform inspections of the development site. In applying for a grading permit, the applicant shall be deemed to have consented to such inspections.
- (c) The city official, through such periodic inspections, shall ensure that all erosion control measures are implemented within one (1) week after cessation or completion of all or portions of authorized work. The city official may where necessary, order remedial work or issue a stop work order in accordance with this chapter.

(Ord. No. 19,353, § 2, 7-19-05)

Sec. 29-195. Reserved.

Sec. 29-196. Land restoration requirements.

All land restoration corrective action activities resulting from land alteration violations shall comply with following conditions:

- (1) Submit site restoration and erosion control plans to public works for approval prior to beginning restoration work.
- (2) All restoration work must be begin within ten (10) calendar days of plans approval and conclude within thirty (30) calendar days of commencement unless otherwise provided by the approved plan or other uncontrollable conditions.
- (3) Prior to commencing restoration activities, erosion controls such as silt fence, hay bales, and rock check dams shall be installed and shall remain in place until restoration activities are complete.
- (4) Return all ground surface contours to those in existence prior to land alteration violation while maintaining positive drainage. All slopes must be 3:1 or flatter. Terraces are prohibited.
- (5) All spoil materials and debris including tree debris must be removed from the property.

(6) Replant one (1) tree for every seven hundred fifty (750) square feet of the area of violation, as determined by the city official, with an average linear spacing of not less than thirty (30) feet with at least two-inch caliper nursery- or farm-grown trees of the same species as those cleared, harvested, removed or damaged. Planting specifications shall be provided on the plan including soil preparation, staking and other necessary measures to ensure trees thrive. If the city official determines the current season of the year is not conducive to sustaining life for trees, the time compliance with these provisions may be extended for not more than one hundred eighty (180) days.

(7) Establish a permanent vegetative cover of perennial grasses with the addition of fertilizer mixes conducive to site conditions.

(8) For one (1) year, restored trees shall be watered once per month and additionally every ten (10) calendar days during the months of June, July, August, and September.

(9) Final inspection and approval is required following completion of required restoration activities. All incomplete items or additional work identified during the final inspection must be completed within seven (7) calendar days following the final inspection.

(10) All restoration work is to be guaranteed by the responsible party in the form of cash, surety bond or letter of credit as referenced in subsection 31-431(2) for two (2) years following its installation and approval by the department of public works.

(11) All permits and approvals must be obtained from all federal, state, and local agencies prior to commencing work.

(12) All restoration work shall be required as stated above unless approved otherwise by the city official.

(Ord. No. 19,353, § 2, 7-19-05)

1 **ORDINANCE NO. 19,497**

2

3 **AN ORDINANCE TO AMEND LITTLE ROCK, ARK., REV.**
4 **CODE § 29-1 TO § 29-196 (1988) TO ADD PROVISIONS**
5 **REQUIRED BY THE CITY'S NATIONAL POLLUTANT**
6 **DISCHARGE ELIMINATION SYSTEM PERMIT AND TO**
7 **FURTHER CLARIFY THE STATUS OF CERTAIN**
8 **DISCHARGES OF NON-STORMWATER TO THE CITY'S**
9 **MUNICIPAL SEPARATE STORM SEWER SYSTEM; TO**
10 **DECLARE AN EMERGENCY; AND FOR OTHER**
11 **PURPOSES.**

12

13 **WHEREAS**, on July 31, 2005, the Arkansas Department of Environmental
14 Quality issued the City a new National Pollutant Discharge Elimination System
15 ("NPDES") Permit No. ARS000002 effective September 1, 2005, and

16 **WHEREAS**, because of the requirements of the City's NPDES permit, it has
17 become necessary to amend Chapter 29 of the Little Rock Code, Stormwater
18 Management and Drainage, to clarify the requirements of the operator of the Little Rock
19 Sanitary Sewer System relative to certain discharges from the Little Rock Sanitary Sewer
20 System, and

21 **WHEREAS**, it is also necessary to amend Chapter 29 of the Little Rock Code to
22 further clarify the status of certain discharges of non-storm water to the City's
23 municipal separate storm sewer system.

24 **NOW, THEREFORE, BE IT ORDAINED BY THE BOARD OF DIRECTORS**
25 **OF THE CITY OF LITTLE ROCK, ARKANSAS:**

1 **Section 1.** A new Little Rock, Ark., Rev. Code § 29-43 (1988), **Unpermitted**
2 **discharges of dry and wet weather overflows from sanitary sewers into the city’s**
3 **municipal separate storm sewer system**, is hereby added as follows:

4 “The operator of the Little Rock Sanitary Sewer System shall eliminate
5 unpermitted discharges of dry and wet weather overflows from sanitary
6 sewers into the city’s municipal separate storm sewer system.”

7 **Section 2.** A new Little Rock, Ark., Rev. Code § 29-44 (1988), **Infiltration from**
8 **sanitary sewers into the city’s municipal separate storm sewer system**, is hereby
9 added as follows:

10 “The operator of the Little Rock Sanitary Sewer System shall limit the
11 infiltration from sanitary sewers into the city’s municipal separate storm
12 sewer system.”

13 **Section 3.** A new Little Rock, Ark., Rev. Code § 29-45 (1988), **Discharge of**
14 **non-storm water to the city’s municipal separate storm sewer system**, is hereby added
15 as follows:

16 “(a) Except as provided in paragraph (b) below, it shall be unlawful to
17 discharge non-storm water to the city’s municipal separate storm sewer
18 system.

19 (b) Unless identified by the city, the U. S. Environmental Protection
20 Agency, or the State of Arkansas as significant sources of pollutants to
21 waters of the State, it shall not be unlawful to discharge the following
22 non-storm water into the city’s municipal separate storm sewer system:

- 23 (1) water line flushing;
- 24 (2) landscape irrigation;
- 25 (3) diverted stream flows;
- 26 (4) rising ground waters;

1
2
3
4
5
6
7
8
9
10
11
12
13
14
15
16
17
18
19
20
21
22
23
24
25
26
27

- (5) uncontaminated ground water infiltration [as defined at 40 CFR 35.2005(20)] to separate storm sewers;
- (6) uncontaminated pumped ground water;
- (7) discharges from potable water sources;
- (8) foundation drains;
- (9) air conditioning condensate;
- (10) irrigation water;
- (11) springs;
- (12) water from crawl space pumps;
- (13) footing drains;
- (14) lawn watering;
- (15) individual residential car washing;
- (16) flows from riparian habitats and wetlands;
- (17) dechlorinated swimming pool discharges;
- (18) street wash waters; and
- (19) discharges or flows from emergency fire fighting activities."

Section 4. A new Little Rock, Ark., Rev. Code § 29-46 (1988), **Discharge of used motor vehicle fluids and household hazardous wastes into the city's municipal separate storm sewer system**, is hereby added as follows:

"It shall be unlawful to discharge used motor vehicle fluids and household hazardous wastes into the city's municipal separate storm sewer system."

Section 5. Severability. In the event any section, subsection, subdivision, paragraph, subparagraph, item, sentence, clause, phrase, or word of this ordinance is declared or adjudged to be invalid or unconstitutional, such declaration or adjudication shall not affect the remaining provisions of this ordinance, as if such invalid or unconstitutional provision was not originally a part of this ordinance.

1 **Section 6. Repealer.** All ordinances, resolutions, bylaws, and other matters
2 inconsistent with this ordinance are hereby repealed to the extent of such inconsistency.

3 **Section 7. Emergency.** *Because the City is required by both the Arkansas*
4 *Department of Environmental Quality and the U. S. Environmental Protection Agency to*
5 *comply with the provisions of NPDES Permit No. ARS000002, and because Chapter 29,*
6 *Stormwater Management and Drainage, of the City code is essential to compliance with the*
7 *City's NPDES permit and is also essential to protect the public health, safety and welfare, an*
8 *emergency is declared to exist and this ordinance shall be in full force and effect from and after*
9 *the date of this adoption.*

10 **PASSED: March 7, 2006**

11

12 **ATTEST:**

APPROVED:

13

14 
15 Nancy Wood, City Clerk

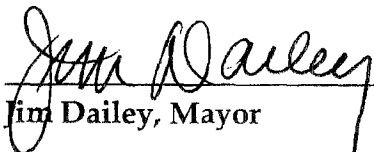
Jim Dailey, Mayor

16

17 **APPROVED AS TO LEGAL FORM:**

18

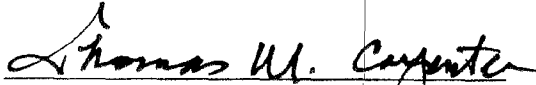
19 
20 Thomas M. Carpenter, City Attorney

21 //

22 //

23 //

24 //

25 //

26 //

27 //

ORDINANCE NO. 19,353

AN ORDINANCE AMENDING CHAPTER 29 OF LITTLE ROCK, ARK. REV. CODE (1988) PROVIDING FOR THE AMENDMENT OF ARTICLE I, SECTION 29-1, BY ADDING CERTAIN DEFINITIONS; DELETING ARTICLE VI. "LAND ALTERATION REGULATIONS" ENTIRELY AND SUBSTITUTING REPLACEMENT PROVISIONS THEREFOR; AND FOR OTHER PURPOSES.

WHEREAS, the City has experienced development activity causing the displacement of tree cover and large amounts of earth, and

WHEREAS, significant problems have resulted from such development and impaired the quality of life such that the general appearance of the City has been compromised; and

WHEREAS, these problems are a concern because of their negative impact on the community, and

WHEREAS, new provisions for land alteration were passed by the City Board of Directors after a citizen task force composed of interested citizens met for more than two years to study land alteration issues, and

WHEREAS, since the new land alteration provisions have been in effect, experience has shown that some further clarifications and changes to those provisions would be in the best interests of the City, and

WHEREAS, the revised Chapter 29 was considered by the Little Rock Planning Commission, and the City Beautiful Commission and the Board of Directors now desires for the City to adopt the amendments to the land alteration provisions as set forth below for the health, safety and welfare of the City.

1 **NOW, THEREFORE, BE IT ORDAINED BY THE BOARD OF DIRECTORS**
2 **OF THE CITY OF LITTLE ROCK, ARKANSAS:**

3 **Section 1.** Article I of Chapter 29 of Little Rock, Ark. Rev. Code (1988) ("LRC"),
4 Section 29-1 "Definitions" is amended to add the following definitions:

5 *Clearing* means the act of cutting, harvesting, removing from the ground,
6 burning, damaging or destroying trees, stumps, hedge, brush, roots, logs, or scalping
7 existing vegetation.

8 *Clear cutting* means removing of substantially all merchantable standing trees.

9 *Grading permit* means the permit issued by Public Works for grading, clearing,
10 harvesting, filling, excavating, quarrying, tunneling, trenching, construction, or similar
11 activities in the City of Little Rock.

12 *Imminent construction* means the installation of a foundation or erection of a
13 structure without unreasonable delay following land alteration activities as determined
14 by the Director of Public Works.

15 *Land alteration* means the process of grading, clearing, harvesting, filling,
16 excavating, quarrying, tunneling, trenching, construction or similar activities, unless
17 excluded by section 29-187.

18 *Responsible party* means any person or entity having control of the property
19 subject to this chapter.

20 **Section 2.** Article VI. of Chapter 29 is deleted in its entirety and replaced with the
21 following provisions:

22 **ARTICLE VI. LAND ALTERATION REGULATIONS**

23 **DIVISION 1. GENERALLY**

24 **Sec. 29-166. Penalty.**

25 Any person convicted of a violation of any of the provisions of this chapter shall
26 be punished as provided in section 1-9.

1 **Sec. 29-167. Findings.**

2 The city has experienced development activity causing the displacement of large
3 amounts of earth and tree cover. Significant problems resulting from such development
4 include flooding, soil erosion and sedimentation, unstable slopes, and impaired quality
5 of life. These problems are a concern because of their negative effects on the safety and
6 general welfare of the community.

7 **Sec. 29-168. Purpose.**

8 The purposes of this chapter are to:

- 9 (1) Prohibit the indiscriminate clearing of property.
- 10 (2) Prevent excessive grading, clearing, filling, cutting or similar
11 activities.
- 12 (3) Substantially reduce flooding, erosion and sediment damage
13 within the city.
- 14 (5) To safeguard the safety and welfare of citizens.
- 15 (6) Establish reasonable standards and procedures for
16 development which prevent potential flooding, erosion and
17 sediment damage.
- 18 (7) Prevent the pollution of streams, ponds and other
19 watercourses by sediment.
- 20 (8) Minimize the danger of flood loss and property loss due to
21 unstable slopes.
- 22 (9) Preserve natural vegetation which enhances the quality of
23 life of the community.
- 24 (10) To conceal hillside scars.
- 25 (11) To preserve the contours of the natural landscape and land
26 forms.

1 **Sec. 29-169. General requirements.**

2 Persons engaged in land alteration activities regulated by this chapter shall take
3 measures to protect neighboring public and private properties from damage by such
4 activities. The requirements of this chapter, however, are not intended to prevent the
5 reasonable use of properties as permitted by chapter 36 of this code.

6 **Sec. 29-170. Violation, Enforcement and Penalties.**

7 (a) Violations of any provisions of this chapter shall be punishable as provided in
8 section 1-9 of this code, except that the continuing violation provisions of section 1-9 (c)
9 shall not apply unless (1) an approved plan for correction of the violation(s) has not
10 been implemented by the responsible party within the time specified in the plan, or (2)
11 the responsible party fails to submit a required plan within the time specified.

12 (b) The responsible party shall be liable for all fines levied and remedial action
13 required under this chapter. Each tree removed or improperly preserved or any other
14 activity proscribed by this chapter shall be a separate violation. Each violation shall be
15 considered a separate offense.

16 (c) Any person who engages in land alteration activities regulated by this chapter
17 without obtaining a grading permit shall be required to restore the land to the
18 maximum extent practicable to its original condition in accordance with Section 29-196.

19 (d) When a violation of this chapter is determined to exist, the city official shall
20 issue written notice of violation to the responsible party. The notice shall specify those
21 sections of this chapter which are determined to be violated and shall include the time
22 and conditions under which the violation(s) shall be corrected. If it is determined that
23 the restoration is not feasible due to imminent construction, (1) a citation may be issued
24 and fines may be levied; (2) the site shall be graded to obtain positive drainage; and (3)
25 the site shall be stabilized with vegetation and the addition of erosion controls. If the
26 responsible party has been issued either a notice of violation or stop work order within

1 the previous twelve (12) month period, the notice may require the violation(s) to be
2 corrected within twenty-four (24) hours.

3 (e) The responsible party shall have a maximum of ten (10) calendar days from
4 the date of the written notice to appeal the finding of the violation(s) to the planning
5 commission as provided in Section 29-172.

6 (f) If the responsible party fails to comply with the written notice of violation the
7 city official may issue a stop work order and citation, as provided in section 29-10 and
8 revoke all permits including the grading permit, building permit, and certificate of
9 occupancy. Additionally, when the city official determines that trees to be protected are
10 in the process of being removed or damaged or other emergencies exist, a stop work
11 order to immediately cease and desist may be issued.

12 (g) The permit applicant shall have on the project site at all times an agent who is
13 a competent superintendent capable of reading and thoroughly understanding the
14 plans, specifications and requirements for areas of tree protection for the type of work
15 being performed. The superintendent shall have full authority to issue orders or
16 direction to employees working on site, without delay and to promptly supply such
17 materials, labor, equipment, tools, and incidentals as may be required to complete the
18 work in a proper manner. If no superintendent is on site, the city official may issue the
19 notice of violation and stop work order to the person conducting the violation.

20 (h) Removal of trees with a diameter of six (6) inches or greater measured four
21 and one half (4.5) feet above the ground that have been removed without a grading
22 permit or trees required in an approved plan that have been removed or which die shall
23 be considered a violation.

24 (i) If a land alteration activity causes damage to off-site property or water, the
25 responsible party shall be required to mitigate the damage and install such additional
26 erosion controls, as approved by the city official, to prevent further damage.

1 (j) Damage to private or public property due to hauling operations or operation
2 of construction related equipment from a nearby construction site shall be repaired by
3 the responsible party prior to issuance of a certificate of occupancy.

4 **Sec. 29-171. Conflicts.**

5 Where provisions of this chapter conflict with any other ordinance, regulation, or
6 resolution of the City, the most stringent provision shall be enforced. The provisions of
7 this chapter are considered minimum requirements.

8 **Sec. 29-172. Hearing before Planning Commission.**

9 Appeals of a notice of violation as provided for in section 29-170(e), a grading
10 and drainage plan decision, or a restoration plan requirement as provided in section 29-
11 196 shall be heard by the planning commission provided an appeal is filed by the
12 applicant within ten (10) calendar days after the date of the notice of violation, fee(s) are
13 paid, and proper public notice is given. Any hearing before the planning commission
14 regarding such appeal will be conducted in the following manner:

15 a) The appellant shall submit an application and fee as provided in section 29-193 to
16 the director of public works within the time limits provided for in section 29-
17 170(e). The appellant shall provide (1) a cover letter that clearly sets forth the
18 provisions of the ordinance that are being appealed and (2) a copy of all
19 pertinent graphic materials or correspondence. Appealable issues are as follows:

20 (1) for a notice of violation, appealable issues are the determination that a
21 violation has occurred, the time frame for correcting the violation, and the
22 corrective action to be required;

23 (2) for a grading and drainage plan decision, appealable issues are the denial
24 of a grading permit and the terms of a grading permit.

25 (3) For a restoration plan, appealable issues are any requirements of section
26 29-196.

1 b) Certified mail notice of all appeals shall be given by the applicant to adjacent
2 property owners, including those across a street or alley from the subject
3 property, at least ten (10) days prior to the planning commission meeting at
4 which the appeal is to be considered. At least three (3) business days prior to the
5 hearing, the appellant shall provide proof of notice to the director of public
6 works. Failure to provide the required notice will cause the appeal to the
7 planning commission to be dismissed, although minor irregularities in the giving
8 of notice may be waived by the commission.

9 c) At the conclusion of questioning and statements, the chairman will call the
10 appeal to a vote as follows:

11 (1) For an appeal of the finding of a violation, either to affirm or overturn the
12 finding of violation; upon affirmation of a finding of violation, a citation
13 may be issued to the appellant;

14 (2) For an appeal of the time to correct the violation, either to affirm the time
15 or determine a new time;

16 (3) For an appeal of the corrective action, either to affirm, determine a new
17 corrective action, or decide that a corrective action is not feasible. A
18 finding that a corrective action is not feasible or appellant's refusal to
19 comply with the commission's decision may result in a citation being
20 issued to the appellant.

21 (4) For an appeal of a grading and drainage plan decision, either affirm or
22 overturn the decision to deny a grading permit, either affirm the permit
23 term or establish a new permit term.

24 (5) For an appeal of a restoration plan or plan provision, either to affirm,
25 determine a new provision or provisions, or decide that restoration is not
26 feasible. A citation may be issued after finding that restoration is not

1 feasible or upon appellant's refusal to fully comply with the restoration
2 measures required by the planning commission.

3 (d) Decisions by the Commission shall be final and are not appealable to the City
4 Board of Directors.

5 **DIVISION 2. GRADING PERMIT AND**
6 **GRADING AND DRAINAGE PLAN**

7 **Sec. 29-186. Grading Permit Required.**

8 (a) Any person proposing to engage in clearing, filling, cutting, harvesting,
9 quarrying, construction or similar activities regulated by this chapter shall apply by
10 means of a grading permit application obtained from the city for a grading permit as
11 specified in this chapter. The city shall have a maximum three (3) working days to
12 review the grading permit application before a permit is issued. Grading permits shall
13 not be issued while applications are incomplete. A landscape permit as required in
14 Chapter 15 shall be obtained from the city before constructing or expanding a vehicular
15 use area. Additionally, a permit is required when expanding or rehabilitating a
16 building and landscaping is required under this chapter. Except as otherwise provided
17 in Chapter 15, the responsible party shall not allow the removal of more than seven (7)
18 trees within any given twelve (12) month period without first obtaining a grading
19 permit. No land shall be altered or cleared to the extent regulated in this chapter unless
20 approved by a permit.

21 (b) No land alteration shall be permitted until all necessary city approval of all
22 plans and permits, except building permit, have been issued and construction is
23 imminent. Clearing and grading for streets and drainage improvements may be done
24 on residential subdivisions provided the preliminary plat has been approved. In those
25 cases where filling or cutting in areas with 7 or fewer trees is to be done, the area is to be
26 graded suitable for mowing and shall be revegetated within twenty one (21) calendar

1 days of grading completion. If building construction has not commenced and been
2 diligently pursued within eight (8) months of grading permit issuance, then all
3 disturbed areas must be restored in accordance with Section 29-196 and landscaping
4 and tree requirements in the buffers shall be installed, unless the city official determines
5 that the existing buffers on the site meet the landscape planting requirements of chapter
6 15 and zoning requirements of chapter 36 of this code.

7 (c) A grading permit is required for land alteration activities specified in this
8 section. All construction work shall include appropriate drainage and erosion control
9 measures to protect neighboring properties. All land alteration on properties within the
10 designated floodplain requires a grading permit without exception.

11 (d) Grading permits, which may be obtained as part of a building permit, shall be
12 required for any of the following activities:

- 13 (1) A top of hill or hillside cuts or fills greater than ten (10) feet
14 vertical.
- 15 (2) Any construction activity where the total volume of cut or
16 fill is equal to or greater than one thousand (1,000) cubic
17 yards.
- 18 (3) Clearing or cutting of trees on property in the City of Little
19 Rock except for (i) those districts zoned agriculture and
20 forestry (AF); (ii) mining (M); and (iii) properties abutting on
21 a collector street of two (2) acres or less zoned single or two
22 family districts R1, R2, R3, R4, or R7A, and residentially
23 zoned properties of five (5) acres or less fronting on a
24 residential street.

1 (e) Prior to issuance of a grading permit, a grading and drainage plan shall be
2 submitted to and approved by the City for activities specified in paragraphs (d)(1), (2)
3 and (3) of this section.

4 (f) When the application is for a planned zoning district, conditional use permit,
5 site plan review, subdivision, or multiple building site approval, a sketch grading and
6 drainage plan shall be required in the application to the planning commission only if
7 any of the activities specified in subsection (d) of this section are involved.

8 (g) Utility organizations may obtain a one-time approval from the city for all
9 routine tree trimming and installation, maintenance, replacement and repair of fence
10 and sign posts, telephone poles and other kinds of posts or poles and overhead or
11 underground electric, water, sewer, natural gas, telephone or cable facilities. The
12 approval will include a utility organization and its contractors, agents or assigns and
13 will be permanent in nature as long as the original approved procedures are followed.
14 However, large-scale utility projects involving clearing of areas over twenty-five (25)
15 feet in width shall not be authorized by one-time approval of all projects. In such cases,
16 a separate grading permit must be obtained for each project.

17 (h) One-time approval may be obtained by public or private entities for the
18 stockpiling of construction spoil material and concrete and asphalt rubble at particular
19 locations for a limited time period, not to exceed (6) six months. Grading and
20 replanting of grassed areas and trees is required upon removal of stockpile.

21 **Sec. 29-187. Exemptions and variances.**

22 (a) A grading permit shall not be required for:

- 23 (1) Construction on properties in the City of Little Rock (i)
24 zoned agriculture and forestry (AF); (ii) properties abutting
25 on a collector street of two (2) acres or less zoned single or
26 two family districts R1, R2, R3, R4 or R7A, and residentially

1 zoned property five (5) acres or less fronting on a residential
2 street.

3 (2) Emergency work or repairs to protect health, safety and
4 welfare of the public. Removal of damaged or diseased trees
5 will be permitted by staff upon certification by the city
6 forester of the condition of the trees sought to be removed;
7 and

8 (3) Mining and mining operations because these activities are
9 covered by the Arkansas Open Cut Land Reclamation Act
10 [A.C.A. Section 15-57-301 as amended], which is regulated
11 by the state Department of Environmental Quality.

12 (b) The planning commission may grant variances from the
13 standards set forth in this article provided that a variance
14 request is filed by the applicant, fee(s) are paid, and proper
15 public notice is given. The applicant shall submit a variance
16 request application and fee as provided in section 29-193 to
17 the director of public works. As part of the application, the
18 applicant shall provide (1) a cover letter that clearly sets
19 forth the provisions of the code from which a variance is
20 requested and (2) a copy of all pertinent graphic materials or
21 correspondence.

22 (c) Certified mail notice of all variance requests shall be given
23 by the applicant to adjacent property owners, including
24 those across a street or alley from the subject property, at
25 least ten (10) days prior to the planning commission meeting
26 at which the variance is to be considered. At least three (3)

1 business days prior to the hearing, the applicant shall
2 provide proof of proper notice to the director of public
3 works. Failure to provide the required notice will cause the
4 variance request to the planning commission to be
5 dismissed, although minor irregularities in the giving of
6 notice may be waived by the commission.

7 (d) Appeals from the variance decision of the planning
8 commission shall be filed with the appropriate court of
9 jurisdiction within thirty (30) calendar days of the decision
10 of the planning commission.

11 (e) Variances may be granted, to the extent that the change will
12 not be contrary to the purposes set forth in section 29-168:

13 (1) To clear and grade a multi-lot or multi-phase development
14 where construction is not imminent on all phases of the
15 development;

16 (2) To harvest timber on land not otherwise allowed under this
17 section in accordance with a reasonable staff approved
18 forestry management plan which is determined to be
19 reasonable and prepared by a registered forester or certified
20 arborist using best management practice guidelines for
21 silviculture in urban areas, that complies with the purposes
22 and requirements of this article; however, clear cutting or
23 total harvests shall not be allowed;

24 (3) To exceed the cut, fill, and slope requirements of Sec. 29-190;

25 (4) From the restoration requirements of Sec. 29-196.

1 The planning commission may impose conditions on the approval of variances. Where
2 variances are granted, applicants shall otherwise comply with all other provisions of the
3 ordinance including, but not limited to, obtaining a grading permit prior to construction
4 or tree removal, meeting the standards for grading, drainage, tree removal, maintaining
5 buffer zones, erosion controls, and establishing of vegetative cover following grading
6 activities.

7 **Sec. 29-188. Contents of grading and drainage plans.**

8 (a) The sketch grading and drainage plan shall identify the following:

9 (1) Acreage of the proposed project.

10 (2) Land areas to be disturbed.

11 (3) Stages of grading showing the limits of sections to be graded
12 and indicating the approximate order of development.

13 (4) The height and slope of cuts and fills. Cross sections may be
14 required every fifty (50) feet on property where the depth of
15 excavation or fill exceeds ten (10) feet, showing original and
16 final grades and will include visual aids to show how the
17 final development, including planting, and landscaping will
18 look.

19 (5) Provisions for collecting and discharging surface water.

20 (6) Erosion and sediment measures, including structural and
21 vegetative measures for permanent slopes and bank
22 stability.

23 (7) Seal and signature of a registered engineer, architect, or
24 landscape architect, qualified under state regulations to
25 certify that the sketch grading and drainage plan complies
26 with this chapter. However, plans for less than two (2) acres

1 fronting on a collector street, or residentially zoned areas
2 less than (5) five acres fronting on a residential street, where
3 cuts or fills are not greater than ten (10) feet in height or
4 where only tree clearing activities are to be undertaken, may
5 be required by public works to be prepared by a contractor
6 or the property owner.

7 (b) A final grading and drainage plan shall include the following information
8 prior to issuance of grading and special flood hazard development permits:

9 (1) Seal of a registered engineer, architect or landscape architect
10 qualified under state regulations to certify that the grading
11 and drainage plan complies with this chapter.

12 (2) A vicinity drawing showing location of property lines,
13 location and names of all existing or platted streets or other
14 public ways within or immediately adjacent to the tract.

15 (3) Location of all known existing sewers, water mains, culverts
16 and underground utilities within the tract and immediately
17 adjacent thereto; location of existing permanent buildings on
18 or immediately adjacent to the site if right of entry can be
19 obtained to locate the utilities.

20 (4) Identification of rights-of-way or easements affecting the
21 property.

22 (5) Soil loss calculations as estimated by the universal soil loss
23 equation. Allowable soil loss shall not exceed five (5) tons
24 per acre per year. Examples of soil loss calculations are
25 contained in the City's Stormwater Management and
26 Drainage Manual.

- 1 (6) A plan of the site at a minimum scale of one (1) inch equals
2 one hundred (100) feet.
- 3 (7) Such other information required by city officials, including
4 but not limited to:
- 5 a. Address and telephone number of owner,
6 permit applicant and the designated agent
7 responsible for maintenance of erosion and
8 sediment control measures.
- 9 b. The approximate location and width of
10 existing and proposed streets.
- 11 c. The locations and dimensions of all proposed
12 or existing lots.
- 13 d. The locations and dimensions of all parcels of
14 land proposed to be set aside for parks,
15 playgrounds, natural condition perimeters,
16 public use, or for the use of property owners in
17 the proposed development.
- 18 e. Existing and proposed topography at a
19 maximum of five-foot contour intervals for
20 steep terrain; two-foot contour intervals for ten
21 percent (10%) or less grade terrain.
- 22 f. An approximate timing schedule, indicating
23 the anticipated starting and completion dates
24 of the development; a timing schedule for the
25 sequence of grading and application of erosion
26 and sediment control measures.

- 1 g. Acreage of the proposed project.
- 2 h. Identification of unusual material or soils in
3 land areas to be disturbed. If any surface
4 indications of unusual materials or soils that
5 would cause street or lot instability, such as
6 nonvertical tree growth, old slides, seepage, or
7 depressions in the soil are visible before
8 grading, they should be noted and
9 accompanied by the engineer's, architect's,
10 landscape architect's, or contractor's
11 recommendation for correcting such problem
12 areas.
- 13 i. Identification of suitable material to be used for
14 fills shall be accomplished before actual filling
15 begins. If there are any surface indications that
16 local material is not suitable for fills, those
17 areas to be filled with outside material should
18 be identified and the type and source of the fill
19 noted.
- 20 j. Specification of measures to control runoff,
21 erosion and sedimentation during the process
22 of construction, noting those areas where
23 control of runoff will be required during
24 construction and indicating what will be used,
25 such as straw bales, sediment basins, silt dams,

1 brush check dams, lateral hillside ditches, catch
2 basins, etc.

3 k. Measures to protect neighboring built-up areas
4 and city property during process of
5 construction, noting work to be performed,
6 such as cleaning existing ditches, storm
7 culverts and catch basins or raising existing
8 curbs in neighboring areas.

9 l. Provisions to stabilize soils and slopes after
10 completion of streets, sewers and other
11 improvements, noting on the grading plan
12 when and where ground cover will be planted,
13 also noting any other means to be used such as
14 placement of reinforced turf, staked sod, stone
15 embankments, and riprap or construction of
16 retaining walls.

17 (8) The grading and drainage plan shall include areas of tree
18 protection, erosion and sediment control provisions meeting
19 standards established by the city in the stormwater
20 management and drainage manual. Tree lines and
21 individual trees may be required to be shown.

22 **Sec. 29-189. Issuance procedure.**

23 (a) The following procedure shall be implemented for the issuance of a grading
24 permit.

25 (1) The city official shall approve, disapprove or recommend
26 modification of the grading and drainage plan in writing

1 within five (5) working days after the date of submittal of a
2 complete application.

3 (2) Applications for which planning commission approval is
4 required shall be placed on the next available planning
5 commission agenda following city staff review. Sketch
6 grading and drainage plans shall be reviewed by the city
7 and a report prepared by the time of the applicable
8 subdivision subcommittee meeting, if possible, but not later
9 than the applicable planning commission meeting.

10 (3) Except for residential subdivision work, the approval of a
11 sketch grading and drainage plan shall not eliminate the
12 need to submit and have approved a final grading and
13 drainage plan, prior to issuance of a building permit or the
14 initiation of land alteration activities.

15 (4) For residential subdivision work, only a sketch grading and
16 drainage plan shall be required, and clearing and grading
17 work may proceed upon approval of the preliminary plat
18 and issuance of a grading permit. The sketch plan for
19 residential subdivisions shall indicate how runoff, erosion,
20 and sedimentation will be controlled.

21 (b) Upon approval of the final plan, the City shall issue a grading permit. A
22 superintendent capable of understanding the plans and with authority to issue orders
23 to employees performing the land alteration shall properly supervise the land alteration
24 activities.

25 (c) The city official may issue a stop work order if, upon inspection, it is
26 determined that the work is not progressing in accordance with the approved plan.

1 (d) Groups of trees and individual trees that are not to be removed or that can be
2 preserved with reasonable effort in site design or are located within required
3 undisturbed buffer areas shall be protected during construction by protective fencing.
4 The buffer and any preservation areas shall not be used for material storage or for any
5 other purpose. The fencing shall be placed and maintained by the owner until all
6 exterior construction except landscaping has been completed. Individual trees or
7 groups of trees to be preserved outside the buffer area shall be fenced at no less than
8 75% of the area within the drip line of the critical root zone and shall be flagged with
9 bright orange vinyl tape wrapped around the main trunk at a height of four (4) feet or
10 more such that the tape is clearly visible to workers on foot or operating equipment.

11 (e) The city official may allow minor modifications of the plan to alleviate
12 particular problems during the process of construction. In reviewing a request for
13 modifications, the city official may require from the applicant's engineer, architect, or
14 landscape architect appropriate reports and data sufficient to make a decision on the
15 request.

16 (f) Major changes to plans approved by the planning commission either in sketch
17 or final form shall only be permitted by the planning commission. Examples of major
18 changes are those that substantially increase the height of cuts or the area of clearing or
19 grading, or substantially impact neighboring properties. More than twenty percent
20 (20%) increase in height, area or impact will normally be considered a major change.
21 Examples of increased impact include reductions in buffer area, increased runoff onto
22 adjacent properties, and increased site area that is visible from adjacent properties or
23 public streets.

24 **Sec. 29-190. Grading and drainage plan requirements.**

1 Preparation of grading and drainage plans shall follow the stormwater
2 management and drainage manual and shall be designed on the basis of the following
3 considerations:

4 (1) A maximum of thirty (30) vertical feet of fill or excavation
5 (such as three, ten [10] feet vertical terraces or two, fifteen
6 [15] feet vertical terraces) is permitted, however additional
7 development areas may be constructed a minimum of one-
8 hundred fifty (150) feet in width and at a slope of no more
9 than eight percent (8%). The maximum of thirty (30) feet of
10 fill or excavation may again be utilized.

11 a. The depth of fill or excavation shall be
12 measured from the finish grade elevation to
13 the original ground line elevation.

14 b. No more than two hundred (200) feet of terrace
15 can be in a straight line and a minimum of a
16 ten (10) feet curved section, jog, or offset is
17 required for each additional two hundred 200
18 feet of terrace.

19 c. For excavations or fills constructed with slopes
20 flatter than 3:1 (three horizontal to one
21 vertical), terraces are not required nor is there a
22 limit on the height of cut or fill. Planting
23 requirements on these 3:1 slopes shall be the
24 same as required for terraces and shall be
25 spaced uniformly over the slope.

1
2
3
4
5
6
7
8
9
10
11
12
13
14
15
16
17
18
19
20
21
22
23
24
25

- d. Cuts or fills shall be limited to ten (10) feet in height or to fifteen (15) feet if architectural stone is included to protect the vertical face. A series of smaller cuts or fills with terraces, preserving portions of natural vegetation and providing areas for planting, shall be used in situations where more than ten (10) feet of cut or fill is needed.
- e. Terracing width shall be at a ratio of at least one (1) foot of horizontal terrace for every one (1) foot of vertical height, up to a maximum of ten (10) feet. Terraces shall be landscaped with dense evergreen plantings sufficient to screen the cut or fill slope. The terrace may be sloped to drain up to one (1) foot in ten (10) feet of width.
- f. If the slope of the cut or fill is faced with an architectural stone wall, the terrace plantings shall be a minimum of two (2) rows of trees four (4) feet between the rows, staggered not more than twenty (20) feet on centers.
- g. Shrubs and ground cover shall be required in accordance with chapter 15 of this code.
- h. Slopes steeper than 3:1 may be allowed for street improvements in the right-of-way due to

1 rock outcropping or extreme slope intercepts if
2 approved by the director of public works.

3 (2) Development shall be planned to fit topography, soils, geology, hydrology,
4 and other existing site conditions.

5 (3) Provisions shall be made for safety against unstable slopes or slopes subject to
6 erosion and deterioration. The city official may require certified geotechnical analysis
7 for sliding and global stability safety. New cuts and fills forming channel banks may
8 require permanent provisions for erosion control upon determination by the city
9 official.

10 (4) Grading shall complement natural landforms.

11 (5) After grading, all paving, seeding, sodding, or mulching shall be performed
12 in accordance with a reasonable schedule approved by the city official.

13 (6) Open areas not planned for immediate use shall be seeded or sodded. Soil
14 which is exposed for more than twenty-one (21) days with no construction activity shall
15 be seeded, mulched or revegetated in accordance with this code.

16 (7) Areas not well suited to development, as evidenced by existing competent
17 soils, geology, hydrology investigations and reports, should be allocated to open space
18 and recreational uses.

19 (8) The potential for soil loss shall be minimized by retaining natural vegetation
20 wherever possible.

21 (9) Appropriate provisions such as those in the stormwater management and
22 drainage manual shall be used to accommodate stormwater runoff and soil loss
23 occasioned by changed soil and surface conditions during and after development,
24 including the use of vegetation and limitations on soil exposure. If staff determines
25 upon visual inspection that excessive silt from the construction has migrated on or
26 offsite, additional measures to reduce erosion may be required.

1 (10) Permanent improvements such as streets, storm sewers, curb and gutters,
2 and other features for control of storm runoff shall be scheduled as soon as
3 economically and physically feasible before removing vegetation cover from the area, so
4 that large areas are not left bare and exposed for long periods of time beyond the
5 capacity of temporary control measures.

6 (11) A temporary or permanent sediment basin, debris basin, desilting basin or
7 silt trap shall be installed and maintained to substantially reduce sediment from water
8 runoff upon determination by the city official. The volume of the sediment basin shall
9 be three-thousand six hundred (3600) cubic feet per acre for property with average
10 slope steeper than five (5) percent, or eighteen hundred (1800) cubic feet per acre for
11 property with an average slope five (5) percent or flatter. A properly sized sediment
12 basin is required for each separate drainage area within the property being developed.

13 (12) Construction access shall be limited to locations as approved by the city
14 official. Construction access points shall be paved in uniformly graded stone without
15 fines for a minimum length of twenty percent (20%) of the lot depth or fifty (50) feet,
16 whichever is greater, up to a maximum of one hundred (100) feet to prevent tracking
17 onto the city street.

18 (13) Appropriate provisions such as the addition of water or dust retardants shall
19 be utilized to prevent excessive particulate matter from becoming airborne.

20 (14) A perimeter buffer strip shall be temporarily maintained around disturbed
21 areas for erosion control purposes and shall be kept undisturbed except for reasonable
22 access for maintenance. The width of the strip shall be six percent (6%) of the lot width
23 and depth. The minimum width shall be twenty-five (25) feet and the maximum shall
24 be forty (40) feet. In no event shall these temporary strips be less than the width of the
25 permanent buffers required for the development.

1 (15) A minimum strip twenty-five (25) feet wide, undisturbed except for
2 reasonable access, shall be provided along each side of streams having a ten (10) year
3 storm of greater than one hundred fifty (150) cubic feet per second. The twenty-five
4 (25) foot strip shall be measured from the top of the bank. An exception to this
5 requirement is allowed where the only work being done on the site is public street
6 construction.

7 (16) Care shall be exercised to minimize the risk of damage from or to pedestrian
8 and vehicular traffic in the vicinity of a cut or fill by placement of handrails, guardrails,
9 fencing or landscaping.

10 (17) Additional landscape treatment shall be provided in accordance with chapter 15
11 of this code.

12 **Sec. 29-191. Unified plan and permit.**

13 One plan may be submitted incorporating all provisions for compliance with the
14 applicable city zoning, landscaping, drainage detention, grading, clearing, filling,
15 cutting, quarrying, and construction requirements.

16 **Sec. 29-192. Reserved.**

17 **Sec. 29-193. Fees.**

18 A fee for each grading permit shall be paid to the city as follows:

19 <i>Total Project Area</i>	<i>Fee</i>
20 Less than ½ acre	\$ 60.00
21 ½ to 1 acre	\$120.00
22 Greater than 1 acre	\$120.00 for first acre, \$60.00 for
23 each additional acre, up to a maximum of ten (10) acres, not to exceed \$660.00. Fees for	
24 each grading permit will double if the grading permit is issued after a notice of	

1 violation(s) has been issued for violation(s) of the land alteration regulations that have
2 occurred on the subject property.

3 A fee for each appeal and variance shall be paid to the city as follows:

4 Flat Fee\$50.00 plus \$5.00 per acre of the
5 total project area up to ten (10) acres, not to exceed \$100.00

6 **Sec. 29-194. Inspection and compliance.**

7 (a) The department designated by the City Manager shall be responsible for
8 determining whether construction is proceeding according to the approved grading and
9 drainage plan.

10 (b) City officials shall perform inspections of the development site. In applying
11 for a grading permit, the applicant shall be deemed to have consented to such
12 inspections.

13 (c) The city official, through such periodic inspections, shall ensure that all
14 erosion control measures are implemented within one (1) week after cessation or
15 completion of all or portions of authorized work. The city official may where necessary,
16 order remedial work or issue a stop work order in accordance with this chapter.

17 **Sec. 29-195. Reserved.**

18 **Sec. 29-196. Land restoration requirements.**

19 All land restoration corrective action activities resulting from land alteration
20 violations shall comply with following conditions:

21 (1) Submit site restoration and erosion control plans to Public Works for
22 approval prior to beginning restoration work.

23 (2) All restoration work must be begin within ten (10) calendar days of plans
24 approval and conclude within thirty (30) calendar days of commencement
25 unless otherwise provided by the approved plan or other uncontrollable
26 conditions.

- 1 (3) Prior to commencing restoration activities, erosion controls such as silt fence,
2 hay bales, and rock check dams shall be installed and shall remain in place
3 until restoration activities are complete.
- 4 (4) Return all ground surface contours to those in existence prior to land
5 alteration violation while maintaining positive drainage. All slopes must be
6 3:1 or flatter. Terraces are prohibited.
- 7 (5) All spoil materials and debris including tree debris must be removed from the
8 property.
- 9 (6) Replant one (1) tree for every seven hundred fifty (750) square feet of the area
10 of violation, as determined by the city official, with an average linear spacing
11 of not less than thirty (30) feet with at least two (2) inch caliper nursery or
12 farm grown trees of the same species as those cleared, harvested, removed or
13 damaged. Planting specifications shall be provided on the plan including soil
14 preparation, staking and other necessary measures to ensure trees thrive. If
15 the city official determines the current season of the year is not conducive to
16 sustaining life for trees, the time compliance with these provisions may be
17 extended for not more than one hundred eighty (180) days.
- 18 (7) Establish a permanent vegetative cover of perennial grasses with the addition
19 of fertilizer mixes conducive to site conditions.
- 20 (8) For one (1) year, restored trees shall be watered once per month and
21 additionally every ten (10) calendar days during the months of June, July,
22 August, and September.
- 23 (9) Final inspection and approval is required following completion of required
24 restoration activities. All incomplete items or additional work identified
25 during the final inspection must be completed within seven (7) calendar days
26 following the final inspection.

1 (10) All restoration work is to be guaranteed by the responsible party in the form
2 of cash, surety bond or letter of credit as referenced in Section 31-431(2) for
3 two (2) years following its installation and approval by the department of
4 public works.

5 (11) All permits and approvals must be obtained from all federal, state, and local
6 agencies prior to commencing work.

7 (12) All restoration work shall be required as stated above unless approved
8 otherwise by the city official.

9 **Section 3. Severability.** In the event any portion of this ordinance is declared or
10 adjudged to be invalid or unconstitutional, such declaration or adjudication shall not
11 affect the remaining portions of the ordinance, which shall remain in full force and
12 effect as if the portion so declared or adjudged invalid or unconstitutional were not
13 originally a part of this ordinance.

14 **Section 4. Repealer.** All laws, ordinances and regulations and parts thereof in
15 conflict with this ordinance are hereby repealed to the extent of such inconsistency.

16 **Section 5. Emergency Clause.** *The ability to limit, to a reasonable extent, the number*
17 *of trees destroyed or removed as a result of development and redevelopment within the City is*
18 *essential to the public health, safety and welfare. The protection of foliage and open space has*
19 *been demonstrated to increase the overall quality of life within the community, and to reduce*
20 *aspects of urban stress such as crime and temperature. An emergency is, therefore, declared to*
21 *exist and this ordinance shall be in full force and effect from and after the date of its passage.*

22
23 **PASSED: July 19, 2005**

24 //

25 //

26 //

1 ATTEST:

2

3 *Nancy Wood*

4 Nancy Wood, City Clerk

5

APPROVED:

Barbara Graves

Barbara Graves, Vice Mayor

6 APPROVED AS TO LEGAL FORM:

7

8 *Thomas M. Carpenter*

9 Thomas M. Carpenter, City Attorney

10 //

11 //

12 //

13 //

14 //

15 //

16 //

17 //

18 //

19 //

20 //

21 //

22 //

23 //

24 //

25 //

26 //

27 //

ORDINANCE NO. 18,246

1
2
3 **AN ORDINANCE AMENDING CHAPTER 29, ARTICLE VI,**
4 **LITTLE ROCK ARK. REV. CODE (1988) TO REQUIRE A**
5 **BUILDING PERMIT TO BE IN PLACE BEFORE ISSUING A**
6 **GRADING PERMIT; TO PROVIDE FOR A HARDSHIP**
7 **EXCEPTION; TO DECLARE AN EMERGENCY; AND FOR**
8 **OTHER PURPOSES.**
9

10 **WHEREAS,** the City of Little Rock currently regulates the clearing of trees and the grading
11 of land in the City through the issuance of grading permits; and

12 **WHEREAS,** such regulations have been adopted and implemented to address significant
13 problems such as flooding, soil erosion and sedimentation, unstable slopes, drainage, aesthetic issues
14 and impaired quality of life, all of which impact the health, safety and welfare of citizens of the City
15 of Little Rock; and

16 **WHEREAS,** the City regulates the construction of buildings and other improvements on real
17 property through the issuance of building permits; and

18 **WHEREAS,** such regulations are designed to require that structures are built to City codes
19 in a timely manner; and

20 **WHEREAS,** it has recently come to the attention of the Little Rock Board of Directors that
21 the current grading permit requirements have allowed land in the City to be clear cut which has
22 caused the mass elimination of trees at an alarming rate; and

23 **WHEREAS,** such mass elimination of trees potentially increases the likelihood of the
24 problems described herein which the grading permit process is designed to address; and

25 **WHEREAS,** in some instances land has been needlessly clear cut with no particular
26 development plan in mind, but rather to reduce the costs of future development which may have to
27 comply with new land alteration, tree preservation and landscaping regulations now under
28 consideration by the City; and

29 **WHEREAS,** the Board is concerned that more land may be needlessly cleared of trees before
30 the new regulations as adopted by the Board will go into effect, and thereby create a threat to the
31 health, safety and welfare of the citizens of Little Rock; and

1 WHEREAS, the Board deems it necessary to declare an emergency and to require that, for 458
2 a limited time, not to exceed six (6) months from the date this ordinance is adopted, a proper building
3 permit is required to be in place before a grading permit will be issued.

4 **NOW, THEREFORE, BE IT ORDAINED BY THE BOARD OF DIRECTORS OF**
5 **THE CITY OF LITTLE ROCK, ARKANSAS:**

6 **SECTION 1.** Little Rock, Ark., Rev. Code § 29-186 (1988) is hereby amended to add the
7 following subsection:

8 (h) (1) Notwithstanding any other provisions in this Code, no grading permit
9 shall be issued unless a proper building permit is already in place and
10 has been approved by all necessary City departments, unless to meet
11 this requirement would impose a substantial hardship on the person(s)
12 seeking the grading permit;

13 (2) To establish a substantial hardship pursuant to this subsection, the
14 applicant shall demonstrate to the Little Rock Board of Zoning
15 Adjustment that it is not possible to obtain a building permit until the
16 grading permit has been issued and all grading completed, and that a
17 delay of six months in the issuance of a grading permit will inalterably
18 change the applicant's position and ability to develop the property.

19 **SECTION 2.** The Board of Adjustment shall not grant any variance to § 29-186(h) until
20 there has been a full and complete hearing on the application for a variance. If the City Attorney does
21 not believe that such a hearing has been held, the Board of Directors shall be notified so it can decide
22 whether to appeal the grant of the variance to a court of proper jurisdiction.

23 **SECTION 3.** All notices and publications of proposed ordinances to impose more definite
24 requirements on tree protection and preservation, landscaping and the issuance of grading permits,
25 shall include a request that any person with suggestions for passage, rejection or amendment of the
26 provisions of the ordinances should present such suggestions in written form to the Little Rock
27 Planning Commission. The Board intends to give final consideration of any such ordinances within
28 six (6) months from the effective date of this ordinance.

29 **SECTION 4. Severability.** In the event any section, subsection, subdivision, paragraph,
30 subparagraph, item, sentence, clause, phrase, or word of this ordinance is declared or adjudged to be

1 invalid or unconstitutional, such declaration or adjudication shall not affect the remaining portions
2 of this ordinance which shall remain in full force and effect as if the portion so declared or adjudged
3 invalid or unconstitutional was not originally a part of this ordinance.

4 **SECTION 5. Emergency.** It is hereby found and determined by the Board of Directors of
5 the City of Little Rock that a need exists to modify the current regulations on tree protection and
6 preservation, landscaping and the issuance of grading permits to prevent the needless destruction of
7 trees, which may lead to problems affecting the health, safety and welfare of the citizens of the City
8 of Little Rock. That while the City has been reviewing proposed new regulations, land has been
9 cleared, not in anticipation of imminent development but in anticipation of the new regulations; and
10 in order to assure that trees are not needlessly destroyed while the new regulations are studied, and
11 yet provide sufficient time for the City to make the transition to the new regulations, an emergency
12 is hereby declared to exist, and this Ordinance, being necessary for the preservation of the public
13 peace, health and safety, shall be in full force and effect from and after the date of its passage.

14 **PASSED: March 28, 2000**

16 **ATTEST:**

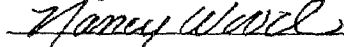
17 

18 Nancy Wood, City Clerk

APPROVED:



Jim Dailey, Mayor

20 **APPROVED AS TO LEGAL FORM:**

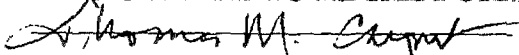
21 

22 Thomas M. Carpenter, City Attorney

23 //

24 //

25 //

26 //

27 //

28 //

29 //

30 //

1
2
3 AN ORDINANCE AMENDING CHAPTER 29 OF LITTLE
4 ROCK, ARK. REV. CODE (1988) PROVIDING FOR THE
5 AMENDMENT OF ARTICLE I "IN GENERAL", SECTION 29-1,
6 DEFINITIONS, BY ADDING THE DEFINITION OF
7 "CLEARING" AND BY AMENDING THE DEFINITION OF
8 "LAND ALTERATION"; DELETING ARTICLE VI. "LAND
9 ALTERATION REGULATIONS" ENTIRELY AND
10 SUBSTITUTING REPLACEMENT PROVISIONS THEREFOR;
11 AND FOR OTHER PURPOSES.

12
13 WHEREAS, the City has experienced development activity causing the
14 displacement of tree cover and large amounts of earth, and

15 WHEREAS, significant problems have resulted from such development and
16 impaired the quality of life such that the general appearance of the City has been
17 compromised; and

18 WHEREAS, these problems are a concern because of their negative impact on
19 the community, and

20 WHEREAS, a citizen task force composed of interested citizens has met for
21 more than two years in an effort to revise the City provisions for land alteration under
22 Chapter 29, and

23 WHEREAS, the task force, representative of the real estate development
24 community and staff, have agreed upon and drafted new provisions for land
25 alteration, and

26 WHEREAS, the revised Chapter 29 was unanimously approved by the Little
27 Rock Planning Commission, and the Board of Directors desires to adopt the new
28 provisions as set forth below for the health, safety and welfare of the City.

1 NOW THEREFORE, BE IT ORDAINED BY THE BOARD OF
2 DIRECTOR OF THE CITY OF LITTLE ROCK, ARKANSAS:

3 SECTION 1. Article I of Chapter 29 of Little Rock, Ark. Rev. Code (1988)
4 (“LRC”), Section 29-1 “Definitions” is amended to add the following definitions:

5 *Clearing* means the act of cutting, removing from the ground, burning,
6 damaging or destroying trees, stumps, hedge, brush, roots, logs, or scalping existing
7 vegetation.

8 *Land alteration* means the process of grading, clearing, filling, excavating,
9 quarrying, tunneling, trenching, construction or similar activities, unless excluded by
10 section 29-187.

11 SECTION 2. Article VI. of Chapter 29 is deleted in its entirety and replaced
12 with the following provisions:

13 ARTICLE VI. LAND ALTERATION REGULATIONS

14 DIVISION 1. GENERALLY

15 Sec. 29-166. Penalty.

16 Any person convicted of a violation of any of the provisions of this chapter
17 shall be punished as provided in section 1-9.

18 Sec. 29-167. Findings.

19 The city has experienced development activity causing the displacement of
20 large amounts of earth and tree cover. Significant problems resulting from such
21 development include flooding, soil erosion and sedimentation, unstable slopes, and
22 impaired quality of life. These problems are a concern because of their negative
23 effects on the safety and general welfare of the community.

24 Sec. 29-168. Purpose.

25 The purposes of this chapter are to:

- 26 (1) Prohibit the indiscriminate clearing of property.

- 1 (2) Prevent excessive grading, clearing, filling, cutting or similar
2 activities.
- 3 (3) Substantially reduce flooding, erosion and sediment damage
4 within the city.
- 5 (5) To safeguard the safety and welfare of citizens.
- 6 (6) Establish reasonable standards and procedures for development
7 which prevent potential flooding, erosion and sediment damage.
- 8 (7) Prevent the pollution of streams, ponds and other watercourses
9 by sediment.
- 10 (8) Minimize the danger of flood loss and property loss due to
11 unstable slopes.
- 12 (9) Preserve natural vegetation which enhances the quality of life of
13 the community.
- 14 (10) To conceal hillside scars.
- 15 (11) To preserve the contours of the natural landscape and land
16 forms.

17 Sec. 29-169. General requirements.

18 Persons engaged in land alteration activities regulated by this chapter shall take
19 measures to protect neighboring public and private properties from damage by such
20 activities. The requirements of this chapter, however, are not intended to prevent the
21 reasonable use of properties as permitted by chapter 36 of this code.

22 Sec. 29-170. Violation, Enforcement and Penalties.

23 (a) Violations of any provisions of this chapter shall be punishable as provided
24 in section 1-9 of this code, except that the continuing violation provisions of section
25 1-9 (c) shall not apply unless (1) an approved plan for correction of the violation(s)
26 has not been implemented by the responsible party within the time specified in the

1 plan, or (2) the responsible party fails to submit a required plan within the time
2 specified.

3 (b) The responsible party shall be liable for all fines levied or remedial action
4 required under this chapter. Each required tree removed or improperly preserved or
5 any other activity proscribed by this chapter shall be a separate violation. Each
6 violation shall be considered a separate offense.

7 (c) Any person who engages in land alteration activities regulated by this
8 chapter without obtaining a grading permit, shall be required to restore the land, to
9 the maximum extent practicable to its original condition.

10 (d) When a violation of this chapter is determined to exist, the city official shall
11 issue written notice of violation to the responsible party. The notice shall specify
12 those sections of this chapter which are determined to be violated and shall include
13 the time and conditions under which the violation(s) shall be corrected. If the
14 responsible party has been issued other written orders within the previous twelve- (12)
15 month period, the notice may require the violation(s) to be corrected within twenty-
16 four (24) hours. If, the city official determines the current season of the year is not
17 conducive to sustaining life for trees, the time compliance with these provisions may
18 be extended for not more than one hundred twenty (120) days.

19 (e) The responsible party shall have a maximum of thirty (30) days from the
20 date of the written notice to appeal to the Planning Commission as provided in
21 Section 29-195.

22 (f) If the responsible party fails to comply with the written notice of violation
23 the city official may issue a stop work order and citation, as provided in section 29-10
24 and revoke all permits including the building permit and certificate of occupancy.
25 Additionally, when the city official determines that an emergency exists, a stop work
26 order to immediately cease and desist may be issued.

1 (g) The permit applicant shall have on the project site at all times an agent who
2 is a competent superintendent capable of reading and thoroughly understanding the
3 plans, specifications and requirements for areas of tree protection for the type of work
4 being performed. The superintendent shall have full authority to issue orders or
5 direction to employees working on site, without delay and to promptly supply such
6 materials, labor, equipment, tools, and incidentals as may be required to complete the
7 work in a proper manner. If no superintendent is on site, the city official may issue
8 the notice of violation and stop work order to the person conducting the violation.

9 (h) Removal of trees with a diameter of six (6) inches or greater, that have been
10 removed without a grading permit or trees required in an approved plan that have
11 been removed or which die shall be considered a violation.

12 (i) If a land alteration activity causes damage to off-site property or water, the
13 developer shall require mitigation by the responsible parties.

14 Sec. 29-171. Conflicts.

15 Where provisions of this chapter conflict with any other ordinance, regulation,
16 or resolution of the City, the most stringent provision shall be enforced. The
17 provisions of this chapter are considered minimum requirements.

18 DIVISION 2. GRADING PERMIT AND
19 GRADING AND DRAINAGE PLAN

20 Sec. 29-186. Grading Permit Required.

21 (a) Any person proposing to engage in clearing, filling, cutting, quarrying,
22 construction or similar activities regulated by this chapter shall apply to the
23 Department of Public Works for a grading permit as specified in this chapter. A
24 landscape permit as required in Chapter 15 shall be obtained from the city before
25 constructing or expanding a vehicular use area. Additionally, a permit is required
26 when expanding or rehabilitating a building and landscaping is required under this
27 chapter. Except as otherwise provided in Chapter 15, the responsible party shall not

1 allow the removal of more than seven (7) trees within any given twelve (12) month
2 period without first obtaining a grading permit. The city official may exempt the need
3 for the permit on a limited case-by-case basis. No land shall be altered or cleared to
4 the extent regulated in this chapter unless approved by a permit.

5 (b) No land alteration shall be permitted until all necessary city approval of all
6 plans and permits, except building permit, have been issued and construction is
7 imminent. Clearing and grading for streets and drainage improvements may be done
8 on residential subdivisions provided the preliminary plat has been approved. In those
9 cases where filling or cutting in areas with no trees is to be done, the area is to be
10 graded suitable for mowing and shall be revegetated. If building construction has not
11 commenced and diligently pursued within eight (8) months of plans approval, then
12 all landscaping and tree requirements in the buffers shall be installed, unless the city
13 official determines that the existing buffers on the site meet the landscape planting
14 requirements of chapter 15 of this code.

15 (c) A grading permit is required for land alteration activities specified in this
16 section. However, all construction work shall include appropriate drainage and
17 erosion control measures to protect neighboring properties. All land alteration in
18 properties within the designated floodplain requires a grading permit without
19 exception.

20 (d) Grading permits, which may be obtained as part of a building permit, shall
21 be required for any of the following activities:

- 22 (1) A top of hill or hillside cut or fills greater than ten (10) feet
23 vertical.
- 24 (2) Any construction activity where the total volume of cut or fill is
25 equal to or greater than one thousand (1,000) cubic yards.
- 26 (3) Clearing or cutting of trees on property in the City of Little Rock
27 except for (i) those districts zoned agriculture and forestry (AF)

1 (ii) mining (M), and (iii) properties fronting on a collector street
2 of two (2) acres or less zoned single or two family districts R1,
3 R2, R3, R4, and R7A, or residentially zoned properties fronting
4 on a residential street of five (5) acres or less.

5 (e) Prior to issuance of a grading permit, a grading and drainage plan shall be
6 submitted to and approved by the City for activities specified in paragraphs (d)(1), (2)
7 and (3) of this section.

8 (f) When the application is for a planned zoning district, conditional use
9 permit, site plan review, subdivision, or multiple building site approval a sketch
10 grading and drainage plan shall be required in the application to the planning
11 commission only if any of the activities specified in subsection (d) of this section are
12 involved.

13 (g) Utility organizations may obtain a one-time approval from the city for all
14 routine tree trimming and installation, maintenance, replacement and repair of fence
15 and sign posts, telephone poles and other kinds of posts or poles and overhead or
16 underground electric, water, sewer, natural gas, telephone or cable facilities. The
17 approval will include a utility organization and its contractors, agents or assigns and
18 will be permanent in nature as long as the original approved procedures are followed.
19 However, large-scale utility projects involving clearing of areas over twenty-five (25)
20 feet in width shall not be authorized by one-time approval of all projects. In such
21 cases, a separate grading permit must be obtained for each project.

22 (h) One-time approval may be obtained by public or private entities for the
23 stockpiling of construction spoil material at particular locations for a limited time
24 period, not to exceed (6) six months. Grading and replanting of grassed areas is
25 required upon removal of stockpile.

26 Sec. 29-187. Exemptions.

27 A grading permit shall not be required for:

- 1 (1) Construction on properties of two (2) acre or less fronting on a
2 collector street and zoned single family districts R1, R2, R3, R4
3 & R7 (A) and on property zoned agriculture and forestry (AF),
4 and residentially zoned property fronting on a residential street
5 of five (5) acres or less.
- 6 (2) Emergency work or repairs to protect health, safety and welfare
7 of the public. Removal of damaged or diseased trees will be
8 permitted by staff upon certification by proper authority.
- 9 (3) Mining and mining operations because these activities are
10 covered by the Arkansas Open Cut Land Reclamation Act
11 [A.C.A. Section 15-57-301 as amended], which is regulated by
12 the state Department of Environmental Quality.

13 Sec. 29-188. Contents of grading and drainage plans.

- 14 (a) The sketch grading and drainage plan shall identify the following:
 - 15 (1) Acreage of the proposed project.
 - 16 (2) Land areas to be disturbed.
 - 17 (3) Stages of grading showing the limits of sections to be graded and
18 indicating the approximate order of development.
 - 19 (4) The height and slope of cuts and fills. Cross sections shall be
20 required every fifty (50) feet on property where the depth of
21 excavation or fill exceeds ten (10) feet, showing original and final
22 grades and will include visual aids to show how the final
23 development, including planting, and landscaping will look.
 - 24 (5) Provisions for collecting and discharging surface water.
 - 25 (6) Erosion and sediment measures, including structural and
26 vegetative measures.

1 (7) Seal and signature of a registered engineer, architect, or
2 landscape architect, qualified under state regulations to certify
3 that the sketch grading and drainage plan complies with this
4 chapter. However, plans for areas less than two (2) acres fronting
5 on a collector street, or residentially zoned areas less than (5) five
6 acres fronting on a residential street, where cuts or fills are not
7 greater than ten (10) feet in height or where only tree clearing
8 activities are to be undertaken, may be prepared by a contractor
9 or the property owner.

10 (b) In addition to the requirements for a sketch grading and drainage plan, a
11 final grading and drainage plan shall include the following information prior to
12 issuance of any required permits:

- 13 (1) Seal of a registered engineer, architect or landscape architect
14 qualified under state regulations to certify that the grading and
15 drainage plan complies with this chapter.
- 16 (2) A vicinity drawing showing location of property lines, location
17 and names of all existing or platted streets or other public ways
18 within or immediately adjacent to the tract.
- 19 (3) Location of all known existing sewers, water mains, culverts and
20 underground utilities within the tract and immediately adjacent
21 thereto; location of existing permanent buildings on or
22 immediately adjacent to the site if right of entry can be obtained
23 to locate same.
- 24 (4) Identification of rights-of-way or easements affecting the
25 property.
- 26 (5) Soil loss calculations as estimated by the universal soil loss
27 equation. Allowable soil loss shall not exceed five (5) tons per

1 acre per year. Examples of soil loss calculations are contained in
2 the City's Stormwater Management and Drainage Manual.

3 (6) A plan of the site at a minimum scale of one (1) inch equals one
4 hundred (100) feet.

5 (7) Such other information required by city official, including but
6 not limited to:

7 a. Address and telephone number of owner, permit applicant
8 and the designated agent responsible for maintenance of
9 erosion and sediment control measures.

10 b. The approximate location and width of existing and
11 proposed streets.

12 c. The locations and dimensions of all proposed or existing
13 lots.

14 d. The locations and dimensions of all parcels of land
15 proposed to be set aside for parks, playgrounds, natural
16 condition perimeters, public use, or for the use of property
17 owners in proposed development.

18 e. Existing and proposed topography at a maximum of five-
19 foot contour intervals.

20 f. An approximate timing schedule, indicating the
21 anticipated starting and completion dates of the
22 development; a timing schedule for the sequence of
23 grading and application of erosion and sediment control
24 measures.

25 g. Acreage of the proposed project.

26 h. Identification of unusual material or soils in land areas to
27 be disturbed. If any surface indications of unusual

1 materials or soils that would cause street or lot instability,
2 such as nonvertical tree growth, old slides, seepage, or
3 depressions in the soil are visible before grading, they
4 should be noted and accompanied by the engineer's,
5 architect's, landscape architect's, or contractor's
6 recommendation for correcting such problem areas.

- 7 i. Identification of suitable material to be used for fills shall
8 be accomplished before actual filling begins. If there are
9 any surface indications that local material is not suitable
10 for fills, those areas to be filled with outside material
11 should be identified and the type and source of the fill
12 noted.
- 13 j. Specification of measures to control runoff, erosion and
14 sedimentation during the process of construction, noting
15 those areas where control of runoff will be required during
16 construction and indicating what will be used, such as
17 straw bales, sediment basins, silt dams, brush check dams,
18 lateral hillside ditches, catch basins, etc.
- 19 k. Measures to protect neighboring built-up areas and city
20 property during process of construction, noting work to be
21 performed, such as cleaning existing ditches, storm
22 culverts and catch basins or raising existing curbs in
23 neighboring areas.
- 24 l. Provisions to stabilize soils and slopes after completion of
25 streets, sewers and other improvements, noting on the
26 grading plan when and where ground cover will be
27 planted, also noting any other means to be used such as

1 placement of stone embankments and riprap or
2 construction of retaining walls.

- 3 (8) The grading and drainage plan shall include areas of tree
4 protection, erosion and sediment control provisions meeting
5 standards established by the city in the stormwater management
6 and drainage manual.

7 Sec. 29-189. Issuance procedure.

8 (a) The following procedure shall be implemented for the issuance of a grading
9 permit.

- 10 (1) The city official shall, in writing approve, disapprove or
11 recommend modification of the grading and drainage plan
12 within ten (10) days after the date of submittal unless otherwise
13 approved by the planning commission.

- 14 (2) Applications for which planning commission approval is required
15 shall be placed on the next available planning commission
16 agenda following city staff review. Sketch grading and drainage
17 plans shall be reviewed by city and a report prepared by the time
18 of the applicable subdivision subcommittee meeting, if possible,
19 but not later than the applicable planning commission meeting.

- 20 (3) Except for residential subdivision work, the approval of a sketch
21 grading and drainage plan shall not eliminate the need to submit
22 and have approved a final grading and drainage plan, prior to
23 issuance of a building permit or the initiation of work.

- 24 (4) For residential subdivision work, only a sketch grading and
25 drainage plan shall be required, and clearing and grading work
26 may proceed upon approval of the preliminary plat. The sketch

1 plan for residential subdivisions shall indicate how runoff,
2 erosion, sedimentation will be controlled.

3 (b) Upon approval of the final plan, the City shall issue a grading permit. A
4 superintendent capable of understanding the plans and with authority to issue orders
5 to employees performing the land alteration shall properly supervise the land
6 alteration work.

7 (c) The city official may issue a stop work order if, upon inspection, it is
8 determined that the work is not progressing in accordance with the approved plan.

9 (d) Groups of trees and individual trees that are not to be removed and
10 required undisturbed buffer areas shall be protected during construction by protective
11 fencing and shall not be used for material storage or for any other purpose. The
12 fencing shall be placed and maintained by the owner until all exterior construction
13 except landscaping has been completed. Individual trees to be preserved outside the
14 protected area shall be fenced at the critical root zone and shall be flagged with bright
15 orange vinyl tape wrapped around the main trunk at a height of four (4) feet or more
16 such that the tape is clearly visible to workers on foot or operating equipment.

17 (e) The city official may allow minor modifications of the plan to alleviate
18 particular problems during the process of construction. In reviewing request for
19 modifications, the city official may require from the applicant's engineer, architect,
20 or landscape architect appropriate reports and data sufficient to make a decision on
21 the request.

22 (f) Major changes to plans approved by the planning commission either in
23 sketch or final form shall only be permitted by the planning commission. Examples
24 of major changes are those that substantially increase the height of cuts, the area of
25 clearing or grading, or impact on neighboring properties. More than twenty percent
26 (20%) increase in height, area or impact will normally be considered a major change.
27 Examples of increased impact include reductions in buffer area, increased runoff onto

1 adjacent properties, and increased site area that is visible from adjacent properties or
2 public streets.

3 Sec. 29-190. Grading and drainage plan requirements.

4 Preparation of grading and drainage plans shall follow the stormwater
5 management and drainage manual and shall be designed on the basis of the following
6 considerations:

7 (1) A maximum of thirty (30) vertical feet of fill or excavation (three,
8 ten [10] feet vertical terraces or two, fifteen [15] feet vertical
9 terraces) is permitted, however additional development areas
10 may be constructed a minimum of one-hundred fifty (150) in
11 width and at a slope of no more than eight percent (8%). The
12 maximum of thirty (30) feet of fill or excavation may again be
13 utilized.

14 a. The depth of fill or excavation shall be measured from the
15 finish grade elevation to the original ground line elevation.

16 b. No more than two hundred (200) feet of terrace can be in
17 a straight line and a minimum of a ten (10) feet curved
18 section, jog, or offset is required for each additional 200
19 feet of terrace.

20 c. For excavations or fills constructed with slopes flatter than
21 3:1 (three horizontal to one vertical), terraces are not
22 required nor is there a limit on the height of cut or fill.
23 Planting requirements on these 3:1 slopes shall be the
24 same as required for terraces and shall be spaced
25 uniformly over the slope.

26 d. Cuts or fills shall be limited to ten (10) feet in height or to
27 fifteen (15) feet if architectural stone is included to protect

1 the vertical face. A series of smaller cuts or fills with
2 terraces, preserving portions of natural vegetation and
3 providing areas for planting, shall be used in situations
4 where more than ten (10) feet of cut or fill is needed.

5 e. Terracing width shall be at a ratio of at least one (1) foot
6 of horizontal terrace for every one (1) foot of vertical
7 height, up to a maximum of ten (10) feet. Terraces shall
8 be landscaped with dense evergreen plantings sufficient to
9 screen the cut or fill slope.

10 f. If the slope of the cut or fill is faced with an architectural
11 stone wall, the terrace plantings shall be a minimum of
12 two (2) rows of trees four (4) feet between the rows,
13 staggered not more than twenty (20) feet on centers.

14 g. Shrubs and ground cover shall be required in accordance
15 with chapter 15 of this code.

16 (2) Development shall be planned to fit topography, soils, geology, hydrology,
17 and other existing site conditions.

18 (3) Provisions shall be made for safety against unstable slopes or slopes subject
19 to erosion and deterioration.

20 (4) Grading shall complement natural landforms.

21 (5) After grading, all paving, seeding, sodding, or mulching shall be performed
22 in accordance with a reasonable schedule approved by the city official.

23 (6) Open areas not planned for immediate use shall be seeded or sodded. Soil
24 which is exposed for more than twenty-one (21) days with no construction activity
25 shall be seeded, mulched or revegetated in accordance with this code.

1 (7) Areas not well suited to development, as evidenced by existing competent
2 soils, geology, hydrology investigations and reports, should be allocated to open
3 space and recreational uses.

4 (8) The potential for soil loss shall be minimized by retaining natural
5 vegetation wherever possible.

6 (9) Appropriate provisions such as those in the stormwater management and
7 drainage manual shall be used to accommodate stormwater runoff and soil loss
8 occasioned by changed soil and surface conditions during and after development,
9 including the use of vegetation and limitations on soil exposure. If staff determines
10 upon visual inspection that excessive silt from the construction has migrated offsite,
11 additional measures to reduce erosion may be required.

12 (10) Permanent improvements such as streets, storm sewers, curb and gutters,
13 and other features for control of storm runoff shall be scheduled as soon as
14 economically and physically feasible before removing vegetation cover from the area,
15 so that large areas are not left bare and exposed for long periods of time beyond the
16 capacity of temporary control measures.

17 (11) A temporary or permanent sediment basin, debris basin, desilting basin
18 or silt trap shall be installed and maintained to substantially reduce sediment from
19 water runoff. The volume of the sediment basin shall be three-thousand (3000) cubic
20 feet per acre for property with average slope greater than five (5) percent, or fifteen-
21 hundred (1500) cubic feet per acre for property with an average slope less than five
22 (5) percent. A properly sized sediment basin is required for each separate drainage
23 area within the property being developed.

24 (12) Construction access shall be limited to locations as approved by the city
25 official. Construction access points shall be graveled for a minimum length of twenty
26 percent (20%) of the lot depth or fifty (50) feet, whichever is greater, up to a
27 maximum of one hundred (100) feet to prevent tracking onto the city street.

1 (13) Appropriate provisions shall be made to prevent excessive particulate
2 matter from becoming airborne.

3 (14) A perimeter buffer strip shall be temporarily maintained around disturbed
4 areas for erosion control purposes and shall be kept undisturbed except for reasonable
5 access for maintenance. The width of the strip shall be six percent (6%) of the lot
6 width and depth. The minimum width shall be twenty-five (25) feet and the
7 maximum shall be forty (40) feet. In no event shall these temporary strips be less than
8 the width of the permanent buffers required for the development.

9 (15) A minimum strip twenty-five (25) feet wide, undisturbed except for
10 reasonable access, shall be provided along each side of streams having a ten-year
11 storm of greater than one hundred fifty (150) cubic feet per second. The 25 foot strip
12 shall be measured from the top of the bank. An exception to this requirement is
13 allowed where the only work being done on the site is public street construction.

14 (16) Care shall be exercised to minimize the risk of damage from or to
15 pedestrian and vehicular traffic in the vicinity of a cut or fill by placement of
16 handrails, guardrails, fencing or landscaping.

17 (17) Additional landscape treatment shall be provided in accordance with
18 chapter 15 of this code.

19 Sec. 29-191. Unified plan and permit.

20 One plan may be submitted incorporating all provisions for compliance with
21 the applicable city zoning, landscaping, drainage detention, grading, clearing, filling,
22 cutting, quarrying, and construction requirements.

23 Sec. 29-192. Reserved.

24 Sec. 29-193. Fees.

25 A fee for each grading permit shall be paid to the city as follows:

<i>Total Project Area</i>	<i>Fee</i>
26 Less than 1/2 acre	\$ 50.00

1	½ to 1 acre	\$100.00
2	Greater than 1 acre	\$100.00 for first
3		acre, \$50.00 for
4		each additional
5		acre, up to a
6		maximum of ten
7		(10) acres, not to
8		exceed \$550.00.

9 Sec. 29-194. Inspection and compliance.

10 (a) The department designated by the City Manager shall be responsible for
11 determining whether construction is proceeding according to the approved grading
12 and drainage plan.

13 (b) City officials shall perform inspections of the development site. In applying
14 for a grading permit, the applicant shall be deemed to have consented to such
15 inspections.

16 (c) The city official, through such periodic inspections, shall ensure that erosion
17 control measures are implemented within one (1) week after cessation or completion
18 of all or portions of authorized work. The city official may where necessary order
19 remedial work or issue a stop work order in accordance with this chapter.

20 Sec. 29-195. Appeals.

21 Final decisions of the city official regarding grading and drainage plans shall
22 be subject to review by the planning commission provided an appeal is filed by the
23 applicant within thirty (30) days after the date of the final written decision of the city
24 official. Certified mail notice of the appeal shall be given by the applicant to adjacent
25 property owners, including those across a street or alley from the subject property, at
26 least ten (10) days prior to the planning commission meeting at which the appeal is
27 to be considered.

1 SECTION 3. Severability. In the event any portion of this ordinance is
2 declared or adjudged to be invalid or unconstitutional, such declaration or
3 adjudication shall not affect the remaining portions of the ordinance, which shall
4 remain in full force and effect as if the portion so declared or adjudged invalid or
5 unconstitutional was not originally a part of this ordinance.

6 SECTION 4. Repealer. All laws, ordinances and regulations and parts thereof
7 in conflict with this ordinance are hereby repealed to the extent of such inconsistency.

8 SECTION 7. *Emergency Clause. The ability to limit, to a reasonable extent,*
9 *the number of trees destroyed or removed as a result of development and*
10 *redevelopment within the City is essential to the public health, safety and welfare.*
11 *The protection of foilage and open space has been demonstrated to increase the*
12 *overall quality of life within the community, and to reduce aspects of urban stress*
13 *such as crime and temperature. If this ordinance is not immediately effective, a*
14 *temporary moratorium on tree removal will expire on September 28, 2000, and the*
15 *result will be over three weeks where no meaningful regulations to protect trees and*
16 *foilage are in place. An emergency is, therefore, declared to exist and this ordinance*
17 *shall be in full force and effect from and after the date of its passage.*

18 PASSED: September 26, 2000

19
20 ATTEST:
21 *Nancy Wood*
22 Nancy Wood, City Clerk
23

APPROVED:
Jim Dailey
Jim Dailey, Mayor

24 APPROVED AS TO LEGAL FORM:
25 *Thomas M. Carpenter*
26 Thomas M. Carpenter, City Attorney
27 //
28 //
29 //

DRAFT NO. 3
3-22-90

ORDINANCE NO. 15,833

AN ORDINANCE AMENDING CHAPTER 29, ARTICLE VI, LAND ALTERATION REGULATION, OF THE LITTLE ROCK CITY CODE, 1988, BY MODIFYING CONDITIONS WHICH REQUIRE AN EXCAVATION PERMIT, MODIFYING GUIDELINES FOR EXCAVATION.

BE IT ORDINANCE BY THE BOARD OF DIRECTORS OF THE CITY OF LITTLE ROCK, ARKANSAS:

SECTION 1. Section 29-1. DEFINITIONS shall be amended to include the following:

"Undisturbed perimeter strip means a perimeter or boundary strip around land areas which have been cleared, cut or filled, which is required to remain in a natural state including topography, trees and vegetation. Enhancements such as additional landscaping or other treatments may be used if approved by the City Engineer."

SECTION 2. Section 29-186. PERMIT REQUIRED subsection (c) shall be amended to read as follows:

"(c) Grading permits, which may be obtained as part of a building permit, shall be required for any of the following activities:

(1) A hillside cut or fill greater than fifteen (15) feet vertical. If such a cut or fill is greater than thirty (30) feet, the application shall be reviewed by the City Engineer and approved by the Planning Commission, prior to issuance of a permit.

(2) Any construction activity where the total volume of cut or fill is equal to or greater than three thousand (3,000) cubic yards.

(3) Clearing or cutting of trees covering twenty-five (25) percent or more of a tract, subject to the following limits:

(See #15,243)

D-42

D-1

DRAFT NO. 3
PAGE 2

(a) The area of clearing must exceed one (1) acre in size before a grading permit is required.

(b) Five (5) acres is the largest area of clearing that can occur without a grading permit, even if the area of clearing and cutting is less than twenty-five (25) percent of a tract.

(4) Grading, filling, hillside cutting, quarrying construction or similar activities involving more than five (5) acres of such activities."

SECTION 3. Section 29-187. EXEMPTIONS shall be amended by deleting subsection (3) and the serial restructuring of the remaining numbered subsections accordingly.

SECTION 4. Section 29-188 is retitled to read follows:

"Section 29-188, CONTENTS OF GRADING AND DRAINAGE PLANS"

SECTION 5. Subsection (a) item (7), shall be amended to read as follows:

"(7) Seal and signature of a registered engineer, architect, or landscape architect which certify that the sketch grading and drainage plan complies with this article. However, plans for areas less than five (5) acres where cuts or fill are not greater than fifteen (15) feet in height, or where only tree clearing activities are to be undertaken, may be prepared by a contractor or the property owner."

SECTION 6. Section 29-190. GRADING AND DRAINAGE PLAN GUIDELINE subsection (1) shall be amended to read as follows:

"(1) Limiting cuts or fills to fifteen (15) feet in height. A series of smaller cuts with terraces, reserving portions of natural vegetation and providing areas for planting, shall be used where feasible in situations where more than fifteen (15) feet of cut or fill is needed. Terracing shall be at a ratio of at least one (1) foot of horizontal terrace for every one (1) foot of vertical height up to a maximum of ten (10) feet."

DRAFT NO. 3
PAGE 3

SECTION 7. Section 29-190. GRADING AND DRAINAGE PLAN GUIDELINES subsection (11) shall be amended to read as follows:

"(11) Maintaining where feasible a perimeter strip, undisturbed except for reasonable access, around areas cleared of trees, the perimeter standard being a twenty-five (25) foot strip. In addition, a strip at least twenty-five (25) feet wide, undisturbed except for reasonable access, shall be provided where feasible along each side of a stream with a ten (10) year storm with a flow greater than one hundred fifty (150) cubic feet per second. The twenty-five (25) foot strip shall be measured from the top of the bank."

SECTION 8. Section 29-190. GRADING AND DRAINAGE PLAN GUIDELINES shall be amended by adding subsections (12), (13) and (14) to read as follows:

"(12) Maintaining where feasible a perimeter strip, undisturbed except for reasonable access, around cuts or fills. The perimeter standard shall have a width equal to the height of the cut or fill up to a maximum width of twenty (20) feet. The total height of a cut and/or fill in one (1) area of the site shall be limited to a maximum of forty-five (45) feet. The widths of these undisturbed areas should be adjusted to maximize the preservation of existing trees and may be reduced where structures placed on the site substantially lessen the visibility of the cut or fill from abutting properties or street.

(13) Minimizing the risk of pedestrian and vehicular traffic in the vicinity of a cut or fill by locating cuts or fills away from likely traffic and by the placement of handrails, guardrails, fencing landscaping between traffic and the cuts of fills.

(14) Additional landscape treatments must be provided in accordance with the Landscape Ordinance of the City of Little Rock."

DRAFT NO. 3
PAGE 4

SECTION 9. Effective date. This ordinance shall be in full force and effect sixty (60) days from and after its passage.

PASSED: April 3, 1990

ATTEST:

Jane Czech
CITY CLERK JANE CZECH

Floyd G. Villines, III
MAYOR FLOYD G. VILLINES, III

ORDINANCE NO. 15,243

(Referred to as the "Excavation Ordinance")

Amended by #15,833

1 AN ORDINANCE AMENDING ORDINANCE NO. 14,780
 2 (STORMWATER MANAGEMENT AND DRAINAGE ORDINANCE)
 3 BY INSERTING A NEW ARTICLE 5A ESTABLISHING
 4 STANDARDS AND SPECIFICATIONS FOR CONTROL OF LAND
 5 ALTERATION ACTIVITIES INCLUDING GRADING, CUTS,
 6 FILLS AND CLEARING; ESTABLISHING THE PROCEDURE FOR
 7 APPROVING AND ISSUING PERMITS; PROVIDING SITE
 8 GRADING AND DRAINAGE PLAN GUIDELINES AND
 9 SPECIFICATIONS; AND FOR OTHER PURPOSES.

10 BE IT ORDAINED BY THE BOARD OF DIRECTORS OF THE CITY OF
 11 LITTLE ROCK, ARKANSAS.

12 SECTION 1. That Ordinance No. 14,780 (Stormwater
 13 Management and Drainage Ordinance), enacted December 4,
 14 1984, is hereby amended by adding thereto a new Article 5A
 15 reading as follows:

ARTICLE 5A

LAND ALTERATION REGULATIONS

16 5A.1 Findings - The City of Little Rock has in the
 17 past experienced development activity causing the
 18 displacement of large amounts of earth and tree cover.
 19 Significant problems resulting from such development have
 20 been flooding, soil erosion and sedimentation, unstable
 21 slopes, and impaired quality of life. These problems are a
 22 concern because of their negative effects on the safety and
 23 general welfare of the community.

24 5A.2 Purpose - The purposes of this Ordinance are to
 25 prevent excessive grading, clearing, filling, cutting or
 26 similar activities; to substantially reduce flooding,
 27
 28
 29
 30
 31
 32
 33
 34
 35
 36

1 erosion and sediment damage within the City of Little Rock;
2 to safeguard the safety and welfare of citizens; to
3 establish reasonable standards and procedures for
4 development which prevent potential flooding, erosion and
5 sediment damage; to prevent the pollution of streams, ponds
6 and other watercourses by sediment; to minimize the danger
7 of flood loss and loss due to unstable slopes; and to
8 preserve natural vegetation which enhances the quality of
9 life of the community.

10
11 5A.3 General Requirements - Persons engaged in land
12 alteration activities regulated by this Ordinance shall take
13 measures to protect neighboring public and private
14 properties from damage by such activities. The require-
15 ments of this ordinance, however, are not intended to
16 prevent the reasonable use of properties as permitted by the
17 Zoning Ordinance.

18
19 5A.4 Scope of Authority - Except as exempted by
20 Section 5A.5, any person, firm, corporation or business
21 proposing to engage in grading, clearing, filling, cutting,
22 quarrying, construction or similar activities regulated by
23 this Ordinance shall apply to the City Engineer for approval
24 of plans and issuance of a grading permit as specified in
25 this Ordinance. No land shall be altered to the extent
26 herein regulated unless such a permit is issued.

27
28 A grading permit is required for large or extensive
29 land alteration activities specified in the next paragraph.
30 However, all construction work shall include appropriate
31 drainage and erosion control measures to protect neighboring
32 properties. Also, all properties within the designated
33 floodplain shall be required to obtain a grading permit
34 without exception.

1 Grading permits, which may be obtained as part of a
2 building permit, shall be required for any of the following
3 activities on land zoned or intended for commercial,
4 industrial, office, multi-family or institutional use,
5 unless exempted in Section 5A.5:
6

- 7 A. A hillside cut greater than 15 feet vertical with
8 a proposed slope greater than one and one-half
9 foot horizontal to one foot vertical (34 degrees)
10 or a fill resulting in an embankment with a slope
11 greater than one and one-half foot horizontal to
12 one foot vertical (34 degrees) and with a height
13 greater than 15 feet vertical. Vertical distances
14 shall be measured from the top and toe of a cut or
15 fill.
16

17 An application for any such activity shall be
18 reviewed by the City Engineer and approved by the
19 Planning Commission, prior to issuance of a
20 permit.
21

- 22 B. Grading, filling, hillside cutting, quarrying,
23 construction or similar activities involving more
24 than five acres of such activities, unless
25 exempted by Section 5A.5 of this Ordinance.
26

- 27 C. Clearing or cutting of trees covering 25 percent
28 or more of a tract, subject to the following
29 limits:

- 30 1. The area of clearing and cutting must exceed
31 one acre in size before a grading permit
32 is required; and
33 2. Five acres is the largest area of clearing
34 or cutting that can occur without a grading
35 permit, even if the area of clearing and
36 cutting is less than 25 percent of a tract.

- 1
2 D. Any construction activity where the total volume
3 of cut or fill is equal to or greater than 3,000
4 cubic yards.
5

6 Prior to issuance of a grading permit, a Grading and
7 Drainage Plan must be submitted to and approved by the City
8 Engineer for activities specified in Subsections B, C, and D
9 of this Section.

10
11 E. Sketch Grading and Drainage Plan
12

- 13 1. A Sketch Grading and Drainage Plan may be
14 submitted for authorization to the City
15 Engineer for agricultural uses or forestry
16 activities on land owned by a forest-related
17 industry.
18
19 2. When the application is for a planned unit
20 development, conditional use permit, site
21 plan review, subdivision, or multiple
22 building site approval, a Sketch Grading and
23 Drainage Plan shall be required in the
24 application to the Planning Commission only
25 if any of the activities specified in
26 Subsections A thru D of this Section are
27 involved.
28

29 F. One-Time Approvals
30

- 31 1. Utility organizations may obtain a one-time
32 approval from the City Engineer for all
33 routine tree trimming and installation,
34 maintenance, replacement and repair of fence
35 and sign posts, telephone poles and other
36 kinds of posts or poles and overhead or

1 underground electric, water, sewer, natural
2 gas, telephone or cable facilities. The
3 approval will include a utility organization
4 and its contractors, agents or assigns and
5 will be permanent in nature as long as the
6 original approved procedures are followed.
7

8 However, large-scale utility projects
9 involving clearing of areas over 25 feet in
10 width shall not be authorized by one-time
11 approval of all projects. In such cases, a
12 separate grading permit must be obtained for
13 each project. The land use shall be
14 considered to be equivalent to industrial
15 uses covered by the provisions of this
16 ordinance.
17

- 18 2. One-time approval may be obtained by public
19 or private entities for the stock piling of
20 construction spoil material at particular
21 locations.
22

23 5A.5 Exemptions - A grading permit shall not be
24 required for:

- 25
26 A. Construction of a single-family residence.
27
28 B. Previously platted single-family residential
29 subdivisions including those for which preliminary
30 plat approval was given prior to the adoption of
31 this Ordinance.
32
33 C. All land alterations totaling five contiguous
34 acres or less, except where such five-acres or
35 less is part of a larger area of common owner-
36 ship that will be altered, and except where any of

1 the activities specified in Subsections A, C and
2 D of Section 5A.4 above is involved.

3
4 D. Emergency work or repairs to protect life, limb
5 or property.

6
7 E. Mining and mining operations. These fall under
8 the Open Cut Land Reclamation Act, which is
9 regulated by the Arkansas Department of Pollution
10 Control and Ecology.

11
12 5A.6 Procedure Required for Issuance of a Permit - For
13 each grading and drainage permit to be issued, the following
14 procedure must be followed:

15
16 A. Grading and Drainage Plan.

17
18 The Plan shall include erosion and sediment
19 control provisions meeting standards established
20 by the Department of Public Works in the
21 Stormwater Management and Drainage Manual.

22
23 B. Approval.

24
25 The City Engineer shall in writing approve,
26 disapprove or recommend modification of the
27 Grading and Drainage Plan within 10 working days
28 after the date of submittal, unless Planning
29 Commission approval is required or a Sketch
30 Grading and Drainage Plan must be submitted as
31 part of a Planning Commission application.
32 Failure of the City Engineer to act upon a Plan
33 within the required 10 working days shall result
34 in automatic approval of the Plan.

1 All applications for which Planning Commission
2 approval is required shall be placed on the next
3 available Planning Commission agenda after the
4 10 day review period. Sketch Grading and Drainage
5 Plans shall be reviewed and reported upon by the
6 City Engineer by the time of the applicable
7 Subdivision Committee meeting, if possible, but
8 not later than the applicable Planning Commission
9 meeting. Except for residential subdivision work,
10 the approval of a Sketch Grading and Drainage Plan
11 shall not eliminate the need to submit and have
12 approved a complete Grading and Drainage Plan,
13 prior to issuance of a building permit or the
14 initiation of work. For residential subdivision
15 work, only a Sketch Grading and Drainage Plan
16 shall be required, and clearing and grading work
17 may proceed prior to approval of construction
18 drawings. The Sketch Plan for residential sub-
19 divisions must indicate how runoff, erosion, and
20 sedimentation will be controlled only during
21 street construction.

22
23 C. Issuance of Grading Permit.

24
25 Upon approval of the final Plan, the Department of
26 Public Works shall issue a grading permit. A stop
27 order may be issued by the City Engineer if, upon
28 inspection, he determines that the work is not
29 progressing in accordance with the approved Plan.
30 The City Engineer may allow modifications of the
31 Plan to alleviate problems encountered by the
32 applicant during the process of construction. In
33 reviewing applications for modifications, the
34 City Engineer may require from the applicant's
35 engineer, architect, or landscape architect
36 appropriate reports and data sufficient to make a

1 decision. Major changes to Plans approved by the
2 Planning Commission either in sketch or final form
3 shall not be permitted without resubmittal to the
4 Commission. Examples of major changes are those
5 that substantially increase the height of cuts,
6 the area of clearing or grading, or impacts on
7 neighboring properties. More than a twenty
8 percent increase in height, area or impact will
9 normally be considered a major change. Examples
10 of increased impacts include reductions in
11 buffer area, increased cubic feet of runoff on
12 adjacent properties, and increased site area that
13 is visible from adjacent properties or a public
14 street.
15

16 5A.7 Grading and Drainage Plan Guidelines -

17 Preparation of Grading and Drainage Plans shall follow the
18 Stormwater Management and Drainage Manual adopted by the
19 Department of Public Works and shall be evaluated on the
20 basis of the following considerations:
21

- 22 A. Limiting cuts to 15 feet in height unless
23 geotechnical information demonstrating slope
24 stability, erosion control, and drainage control
25 is provided, together with a plan for landscaping
26 portions of the cut area. A series of smaller
27 cuts with terraces, reserving portions of natural
28 vegetation and providing areas for planting should
29 be considered in situations where more than 15
30 feet of cut is needed. It is recommended that
31 terracing be at a maximum ratio of one to one,
32 i.e. at least one foot of horizontal terrace for
33 every foot of vertical surface with a maximum of
34 10 vertical feet allotted.
35
36

- 1 B. Planning of development to fit topography,
2 soils, geology, hydrology, and other existing
3 site conditions;
4
- 5 C. Providing for safety against unstable slopes or
6 slopes subject to erosion and deterioration, in
7 in order to protect human lives and property;
8
- 9 D. Grading to complement natural land forms;
10
- 11 E. After grading, accomplishing all paving, seeding,
12 sodding, or mulching in accordance with a
13 reasonable schedule approved by the City
14 Engineer.
15
- 16 F. Allocating to open space and recreation uses
17 those areas not well suited to development, as
18 evidenced by existing competent soils, geology,
19 and hydrology investigations and reports;
20
- 21 G. Minimizing the potential for soil loss by
22 retaining natural vegetation wherever possible;
23
- 24 H. Making appropriate provisions such as those in the
25 City's Stormwater Management and Drainage Manual
26 to accommodate stormwater runoff and soil loss
27 occasioned by changed soil and surface conditions
28 during and after development, including the use of
29 vegetation and limitations on soil exposure;
30
- 31 I. Scheduling permanent improvements such as streets,
32 storm sewers, curb and gutters, and other features
33 for control of storm runoff as soon as economi-
34 cally and physically feasible (not up front),
35 before removing vegetation cover from the area, so
36 that large areas are not left bare and exposed for

1 long periods of time, beyond the capacity of
2 temporary control measures; and
3

4 J. Installing and maintaining temporary or permanent
5 sediment basins, debris basins, desilting basins
6 or silt traps to specifically reduce sediment from
7 runoff water.
8

9 K. Maintaining where feasible a perimeter strip,
10 undisturbed except for reasonable access, around
11 areas cleared of trees covering 25 percent or
12 more of a tract, the perimeter standard being
13 a 25 foot perimeter strip for sites over one
14 acre in size. In addition, a strip at least
15 25 feet wide, undisturbed except for reasonable
16 access, should be provided where feasible on
17 each side of a stream with a 10 year storm
18 greater than 150 cubic feet per second on such
19 sites. The 25 foot strip should be measured
20 from the top of the bank.
21

22 5A.8 Unified Plan and Permit - One plan may be
23 submitted incorporating provisions for compliance, where
24 applicable, with the City's landscaping, drainage detention,
25 grading, clearing, filling, cutting, quarrying, and
26 construction requirements. One permit may be issued to
27 cover all of these requirements.
28

29 5A.9 Declaration - In an application to comply with
30 any of the City's requirements specified in this Section,
31 the applicant must declare large or extensive land
32 alterations described in subsections A, B, C and D of
33 Section 5A.4 of this Ordinance.
34

35 5A.10 Fees - A fee for each grading permit shall be
36 paid as set forth in the table below to the City Collector

1 by each person seeking a permit for land alteration
 2 activities. The permit fee is to defray the costs of
 3 reviewing the site Grading and Drainage Plan, making
 4 on-site inspections, and providing the other services
 5 required in the administration of this Ordinance. No
 6 fee shall be required in connection with a Sketch Grading
 7 Plan filed as part of an application to the Planning
 8 Commission or in connection with a one-time approval.

9
 10 TABLE 17.1 GRADING PERMIT REVIEW AND INSPECTION FEES

Total Project Area	Fee
Less than 1/2 acre	\$25.00 per permit
1/2 acre to 1 acre	\$40.00 per permit
Greater than 1 acre	\$50.00 per acre up to a maximum of \$250.00

21 5A.11 Inspection and Compliance - The City Engineer
 22 shall be responsible for determining whether construction is
 23 proceeding according to the Grading and Drainage Plan.

- 24
 25 A. Inspections of the development site shall be
 26 performed by Department of Public Works
 27 inspectors. In applying for a grading permit,
 28 the applicant shall be deemed to have consented
 29 to such inspections.
- 30
 31 B. The City Engineer, through such periodic
 32 inspections, shall ensure that erosion control
 33 measures are implemented within one week after
 34 cessation or completion of all or portions of
 35 authorized work. The City Engineer may where
 36 necessary order remedial work or issue a stop

1 order in accordance with the procedures in
2 Sections 6.4 and 6.5 of the Stormwater Management
3 and Drainage Ordinance.
4

5 5A.12 Appeals - Final decisions of the City Engineer
6 regarding Grading and Drainage Plans shall be subject to
7 review by the Planning Commission, provided an appeal is
8 filed by the applicant within 30 days after the date of the
9 final written decision. All appeals shall be reviewed by
10 the Subdivision Committee prior to Planning Commission
11 action. Notice of the appeal shall be given to adjacent
12 property owners, including those across a street or alley
13 from the subject property, at least 10 days prior to the
14 Planning Commission meeting at which the appeal is to be
15 considered. Said notice shall be by certified mail and
16 shall be the responsibility of the applicant.
17

18 5A.13 Restoration, Fee, and Special Provisions - In
19 addition to the fine specified in Section 6.2 of the
20 Stormwater Management and Drainage Ordinance, any person,
21 firm, or corporation which engages in land alteration
22 activities regulated by this Ordinance without obtaining a
23 grading permit shall be required to restore the land, to the
24 maximum extent possible, to its original condition by
25 planting and maintaining grass and trees with trunks at
26 least two inches in diameter (measured one foot above ground
27 level) in accordance with accepted spacing standards and by
28 under- taking other restoration activities determined to be
29 feasible by a court of law. Since complete restoration of
30 disturbed areas may not be possible within a reasonable
31 period of time, the violator also shall pay a fee where
32 appropriate in an amount necessary, as determined by the
33 City Engineer, to cover the cost of the City implementing
34 measures to mitigate any potential flooding, erosion, or
35 sediment damage resulting from the violation. All fines
36 received as a result of illegal land alteration activities

1 shall be placed in a special fund to be administered by the
2 City Manager. The fund shall be used for the purpose of
3 restoring disturbed lands, mitigating damages resulting from
4 violations, or otherwise making drainage improvements or
5 planting vegetation in the general vicinity of violations.
6

7 5A.14 Appendix - Appendix A of this Ordinance contains
8 the specifications for a Sketch Grading and Drainage Plan
9 and a complete Grading and Drainage Plan. Said Appendix A
10 is attached hereto and made a part of this Ordinance.
11

12 SECTION 2. Definitions for terms contained in Appendix
13 B of this Ordinance shall be inserted in alphabetical order
14 into Section 1.6 (Definitions) of Ordinance No. 14,780
15 (Stormwater Management and Drainage Ordinance).
16

17 SECTION 3. All prior ordinances or parts of ordinances
18 inconsistent with this ordinance are hereby repealed to the
19 extent of their inconsistency.
20

21 SECTION 4. This Ordinance shall take effect and be in
22 full force 30 days from and after its passage and approval.
23

24
25 PASSED: February 17, 1987

26
27 ATTEST: Jane Czech APPROVED: Lottie Shackelford
28 City Clerk Jane Czech Mayor Lottie Shackelford
29

30
31 APPROVED AS TO FORM: Charles Rodola
32 City Attorney
33
34
35
36

APPENDIX A - SPECIFICATIONS

1
2
3 SECTION A1. Sketch Grading and Drainage Plan. A
4 Sketch Plan shall identify the following:
5

- 6 A. Acreage of the proposed project.
7
8 B. Land areas to be disturbed, shown by hatching
9 or specking such areas which will be graded,
10 cut, filled, or cleared.
11
12 C. Stages of grading showing the limits of
13 sections to be graded and indicating the
14 approximate order of development.
15
16 D. The extent of cuts and fills, shown by
17 drawing a dashed line along the top of the
18 cut and toe of the fill and marking the
19 lines "C" and "F". The height and slope
20 of cuts and fills also shall be indicated.
21
22 E. Provisions for collecting and discharging
23 surface water.
24
25 F. Erosion and sediment measures, including
26 structural and/or vegetative measures.
27
28 G. Seal and signature of a registered engineer,
29 architect, or landscape architect which
30 certify that the Sketch Grading and Drainage
31 Plan complies with the Ordinance. However,
32 plans for areas less than 5 acres where cuts
33 or fills are not greater than 25 feet in
34 height may be prepared by a contractor or the
35 property owner.
36

1 SECTION A2. Grading and Drainage Plan. In addition to
2 the requirements for a Sketch Grading and Drainage Plan, a
3 complete Grading and Drainage Plan shall include the
4 following:
5

- 6 A. Seal of a registered engineer certifying that the
7 Grading and Drainage Plan complies with the
8 Ordinance. The seal of a registered architect
9 or landscape architect will be acceptable if all
10 required boundary street and drainage improve-
11 ments are in place.
12
- 13 B. A vicinity drawing showing: location of property
14 lines; location and names of all existing or
15 platted streets or other public ways within or
16 immediately adjacent to the tract.
17
- 18 C. Location of all known existing sewers, water
19 mains, culverts and underground utilities within
20 the tract and immediately adjacent thereto;
21 location of existing permanent buildings on
22 or immediately adjacent to the site if right of
23 entry can be obtained to locate same.
24
- 25 D. Citation of any existing legal rights-of-way or
26 easements affecting the property.
27
- 28 E. Soil loss calculations as estimated by the
29 Universal Soil Loss Equation (see definition in
30 Appendix B). Allowable soil loss shall not
31 exceed 5 tons per acre per year. Examples of
32 soil loss calculations are contained in the
33 Stormwater Management and Drainage Manual of
34 the Department of Public Works.
35
36

1 F. A plan of the site at a minimum scale of 1 inch =
2 100 feet showing:

- 3
- 4 1. Address and telephone number of the owner,
5 developer, and person responsible for
6 maintenance of the temporary and/or
7 permanent erosion and sediment control
8 measures.
- 9
- 10 2. The approximate location and width of
11 proposed streets.
- 12
- 13 3. The approximate locations and dimensions of
14 all proposed or existing lots.
- 15
- 16 4. The approximate locations and dimensions of
17 all parcels of land proposed to be set aside
18 for parks, playgrounds, natural condition
19 perimeters, public use, or for the
20 use of property owners in the proposed
21 development.
- 22
- 23 5. Existing topography at a maximum of five-foot
24 contour intervals.
- 25
- 26 6. Proposed topography at a maximum of five-foot
27 contour intervals.
- 28
- 29 7. An approximate timing schedule, indicating
30 the anticipated starting and completion dates
31 of the development; a timing schedule for the
32 sequence of grading and application of
33 erosion and sediment control measures.
- 34
- 35 8. Acreage of the proposed project.
- 36

- 1 9. Identification of unusual material or soils
2 in land areas to be disturbed. If any
3 surface indications of unusual materials or
4 soils that would cause street or lot
5 instability, such as nonvertical tree growth,
6 old slides, seepage, or depressions in the
7 soil are visible before grading, they should
8 be noted and accompanied by the engineer's,
9 architect's, landscape architect's, or
10 contractor's recommendation for correcting
11 such problem areas.
12
- 13 10. Identification of suitable material to be
14 used for fills shall be accomplished before
15 actual filling begins. If there are any
16 surface indications that local material is
17 not suitable for fills, those areas to be
18 filled with outside material should be
19 identified and the type and source of the
20 fill material noted.
21
- 22 11. Specification of measures to control runoff,
23 erosion and sedimentation during the process
24 of construction, noting those areas where
25 control of runoff will be required during
26 construction and indicating what will be
27 used, such as straw bales, silt dams, brush
28 check dams, lateral hillside ditches, catch
29 basins, etc.
30
- 31 12. Measures to protect neighboring built-up
32 areas and City property during the process
33 of construction, noting work to be performed,
34 such as cleaning existing ditches, storm
35 culverts and catch basins or raising
36 existing curbs in neighboring areas.

- 1
2
3
4
5
6
7
8
9
10
11
12
13
14
15
16
17
18
19
20
21
22
23
24
25
26
27
28
29
30
31
32
33
34
35
36
13. Provisions to stabilize soils and slopes after completion of streets, sewers and other improvements, noting on the grading plan when and where ground cover will be planted, also noting any other means to be used such as placement of stone embankments and riprap or construction of retaining walls.

APPENDIX B - DEFINITIONS

1
2
3
4
5
6
7
8
9
10
11
12
13
14
15
16
17
18
19
20
21
22
23
24
25
26
27
28
29
30
31
32
33
34
35
36

The following terms utilized in this Ordinance shall be defined as provided below:

Agriculture - All farm enterprises such as: crop land, forage production; animal husbandry, dairy and poultry; and floriculture.

Developer - A person, partnership or a corporation engaged in land alteration activities which are not excluded by the Exemption Section of this Ordinance.

Land Alteration - The process of grading, clearing, filling, cutting, quarrying, construction or similar activities, unless excluded by the Exemption Section of this Ordinance.

Erosion - The wearing away of land by action of wind, water or gravity.

Forestry Operation - An operation conducted on land owned or leased by a major forestry industry corporation for the systematic harvest of timber.

Grading and Drainage Plan - The plan required before a grading permit can be issued.

Mulching - The application of plant or other suitable materials on a soil surface to conserve moisture, reduce erosion, and aid in establishing plant cover.

Sediment - Rock, sand, gravel, silt, clay or other material deposited by action of wind, water or gravity.

1 Sedimentation Basin - The storage area created by a
2 barrier or dam built across a waterway or at other suitable
3 locations to retain rock, sand, gravel, silt, clay or other
4 material.
5

6 Universal Soil Loss Equation - A method developed by
7 the Agricultural Research Service, USDA, and used to
8 estimate soil erosion based on a rainfall, soil erodibility,
9 slope of the land, length of slope and plant cover. The
10 basic form of the equation is:
11

$$12 \quad E = R K L S C P$$

13 Where: E = soil loss, in tons per acre per year

14 R = rainfall factor

15 K = soil erodibility factor

16 LS = slope length gradient factor

17 C = vegetative cover factor

18 P = conservation practice factor
19

20 Examples of soil loss calculations are contained in the
21 Stormwater Management and Drainage Manual of the Department
22 of Public Works.
23
24
25
26
27
28
29
30
31
32
33
34
35
36

STORMWATER MANAGEMENT AND DRAINAGE ORDINANCE

AN ORDINANCE ADOPTING REGULATIONS
DESIGNED TO LESSEN OR AVOID HAZARDS
TO PERSONS AND PROPERTY CAUSED BY
INCREASED STORMWATER RUNOFF OR BY
OBSTRUCTION TO DRAINAGE, AND TO
OTHERWISE PROMOTE THE PUBLIC HEALTH,
SAFETY AND GENERAL WELFARE.

ARTICLE 1.

INTRODUCTORY PROVISIONS

1.1 Title - These regulations shall hereafter be known, cited and referred to as the "Stormwater Management and Drainage Regulations" of the City of Little Rock, Arkansas.

1.2 Authority - These regulations are adopted pursuant to the power and authority vested through the applicable laws and statutes of the state of Arkansas.

1.3 Applicability - Any person, firm, corporation or business proposing to construct buildings or develop land within the Little Rock Planning jurisdiction shall submit drainage plans to the City Engineer for approval of a stormwater management and drainage plan before building permits are issued or subdivisions are approved. No land shall be developed except upon approval by the City Engineer.

1.4 Exemptions - All construction, subdivision approvals or remodeling activities shall have a stormwater management and drainage plan approved before a building permit is issued or subdivision is approved except for the following:

- . One - new or existing single family structure.
- . One - new or existing duplex family structure.
- . One - new commercial or industrial structure located on less than one acre individual lot.
- . One - existing commercial or industrial structure where additional structural improvements are less than 500 square feet.

1.5 Purpose - In order to promote the public health, safety and general welfare of the citizens of Little Rock, the provisions of these regulations, as amended from time to time, are intended to: (1) reduce property damage and human

suffering, and (2) to minimize the hazards of personal injury and loss of life due to flooding, to be accomplished through the approval of a stormwater management and drainage plan pursuant to the provisions of these regulations, which: (a) establish the major and minor stormwater management systems, (b) define and establish stormwater management practices and use restrictions, and (c) establish guidelines for handling increases in volume and peak discharges of runoff.

1.6 Definitions - For the purpose of this Ordinance, certain terms and words shall be used, interpreted and defined as set forth in this section. Unless the context clearly indicates to the contrary, words used in the present tense include the future tense; words used in the singular shall include the plural, and vice-versa; the words, "these regulations," mean "this Ordinance;" the word, "person," includes corporation, partnership, and unincorporated association of persons; and the word, "shall," is always mandatory.

A. Base Flood - The flood that has a 1 percent chance of being equaled or exceeded in any given year, i.e., the 100-Year Flood.

B. Bond - Any form of security for the completion or performance of the stormwater management and drainage plan or the maintenance of drainage improvements, including surety bond, collateral, property or instrument of credit, or escrow deposit in an amount and form satisfactory to the City Engineer.

C. Building - Any structure built for the support, shelter or enclosures of persons, animals, chattels, or movable property of any kind.

D. Channel - Course of perceptible extent which periodically or continuously contains moving water, or which forms a connecting link between two bodies of water, and which has a definite bed and banks.

E. Conduit - Any open or closed device for conveying flowing water.

F. Control - The hydraulic characteristic which determines the stage-discharge relationship in a conduit. The control is usually critical depth, tailwater depth, or uniform depth.

G. Detention Basins - Any man-made area which serves as a means of controlling and temporarily storing stormwater runoff. The facility normally drains completely between spaced runoff events, e.g., parking lots, rooftops, athletic fields, dry wells, oversized storm drain pipes.

H. Detention - The temporary detaining or storage of floodwater in reservoirs, on parking lots, on rooftops and other areas under predetermined and controlled conditions - accompanied by controlled release of the stored water.

I. Detention Pond - A stormwater detention facility which maintains a fixed minimum water elevation between runoff events except for the lowering resulting from losses of water due to infiltration or evaporation.

J. Development - Any change of land use or improvement on any parcel land.

K. Differential Runoff - The volume and rate of flow of stormwater runoff discharged from a parcel of land or drainage area which is or will be greater than the volume and rate which pertained prior to proposed development or redevelopment existed.

L. Drainage Approval - A certificate of approval issued by the City Engineer based upon an approved final stormwater management and drainage plan. The final stormwater management and drainage plan must accompany the building permit application or be submitted with the proposed construction plans.

M. Drainage Easement - Authorization by a property owner for use by another party or parties for all or any portion of his/her land for a drainage and adjoining utility purposes. Easements shall be dedicated to the City when required or approved by the City Engineer.

N. Engineer of Record - A registered professional engineer in Arkansas. This engineer shall supervise the design and construction of the project and shall be acceptable by the City Engineer.

O. Floodplain - A land area adjoining a river, stream, watercourse or lake which is likely to be flooded.

P. Floodway - The channel of a river or other watercourse and the adjacent land areas that must be reserved in order to discharge the base flood without a cumulative increase of the water surface elevation more than a designated height.

Q. Freeboard - A factor of safety expressed as the difference in elevation between the top of the detention basin dam, levees, culvert entrances and other hydraulic structures, and the design flow elevation.

R. Frequency - The reciprocal of the exceedance probability.

S. Habitable Dwelling Unit - A dwelling unit intended and suitable for human habitation.

T. Major Storm Easements - Privately maintained areas designed to carry the 100-year storm with no obstructions allowed such as fill or fences that would impede floodwater flow. Properly designed landscaping that does not impede floodwater or endanger adjacent property may be allowed.

U. Minor Storm Easements - Public maintained areas designed to carry the 10-year (or 50-year for CBD area) storm; provide access for maintenance; and prevent channel obstructions.

V. On-Site Detention - Temporary storage of runoff on the same land development site where the runoff is generated.

W. On-Stream Detention - Temporary storage of runoff within a principal drainage system, i.e., in the receiving streams or conduits.

X. Off-Stream Detention - Temporary storage accomplished off-line, i.e., not within a principal drainage system.

Y. 100-Year Peak Flow - The peak rate of flow of water at a given point in a channel, watercourse or conduit resulting from the base flood.

Z. 100-Year Storm - Rainstorms of a specified duration having a 1 percent chance of occurrence in a given year.

AA. Permittee - A person, partnership or corporation to whom a permit is granted.

BB. Plat - A legally recorded plat of a parcel of land subdivided into lots with streets, alleys, easements, and other land lines drawn to scale.

CC. Project - Any development involving the construction, reconstruction or improvement of structures and/or grounds.

DD. Rational Method - An empirical formula for calculating peak rates of runoff resulting from rainfall.

EE. Retention Facility - Any type of detention facility not provided with a positive outlet.

FF. Stormwater Management and Drainage Manual - The set of drainage policies, analysis methods, design charts,

stormwater runoff methods, and design standards used by the City as the official design guidelines for drainage improvements consistent with this Ordinance. Any modifications will be made by the City Engineer consistent with the stated policies and intent of the Ordinance.

GG. Stormwater Runoff - Water that results from precipitation which is not absorbed by the soil, evaporated into the atmosphere or entrapped by ground surface depressions and vegetation, which flows over the ground surface.

HH. Structure - Any object constructed above or below ground. Pipes, manholes and certain other utility structures which exist underground may be excluded from this definition.

II. Swale - A shallow waterway.

JJ. Time of Concentration - The estimated time in minutes required for runoff to flow from the most remote section of the drainage area to the point at which the flow is to be determined.

KK. Tributary Area - All of the area that contributes stormwater runoff to a given point.

LL. Uniform Channel - A channel with a constant cross section and roughness.

MM. Wet Bottom Basin - A detention basin intended to have a permanent pool.

NN. Watercourse - Any surface stream, creek, brook, branch, depression, reservoir, lake, pond or drainageway in or into which stormwater runoff flows.

ARTICLE 2.

STORMWATER MANAGEMENT AND DRAINAGE SYSTEM.

2.1 General - This article establishes the stormwater runoff management system of the City of Little Rock which shall be composed of a major system and a minor system, management controls and management practices. These regulations shall apply in the minor system.

2.2 The Major System - The major system is the area in any drainageway within the limits of flow of a 100-year storm.

2.3 The Minor System - The minor systems will be composed of all watercourses and drainage structures, both public and private, that are not part of the major system, because of lower design storm frequencies.

2.4 Management Controls - Management controls are regulations applicable to the major system under the provisions of this Ordinance. Such controls shall limit any activity which adversely effect hydraulic function of open channels, drainage swales, detention facilities, or enclosed stormwater conveyance systems. The City of Little Rock Stormwater Management and Drainage Manual, hereafter referred to as the Drainage Manual, shall be the official document used for designing stormwater management controls and drainage systems.

2.5 Management Practices - The following practices may be utilized on approval by the City Engineer.

A. Storage - Runoff may be stored in temporary or permanent detention basins, or through rooftop, parking lot ponding, or percolation storage, or by other means in accordance with the design criteria and performance standards set forth in these regulations.

B. Open Channels - Maximum feasible use shall be made of existing drainageways, open channels and drainage swales that are designed and coordinated with the design of building lots and streets in accordance with the design criteria and performance standards set forth in the Drainage Manual.

C. Curbs - Streets, curbs and gutters shall be an integral part of the stormwater runoff management system. To the maximum extent possible, drainage systems, street layout and grades, lotting patterns and the location of curbs, inlets and site drainage and overflow swales shall be concurrently designed in accordance with design criteria and performance standards set forth in the Drainage Manual.

D. Enclosed Conveyance Systems - Enclosed conveyance systems consisting of inlets, conduits, and manholes may be used to convey stormwater runoff. Where used, such systems must be designed and performance standards set forth in the Drainage Manual.

E. Other - The stormwater runoff management practices enumerated herein shall not constitute an exclusive listing of available management practices. Other generally accepted practices and methods may be approved by the City Engineer, if the purposes, design criteria and minimum performance standards of these regulations are complied with.

2.6 Public and Private Responsibilities Under the Stormwater Management System

A. Public Responsibilities:

1. Administration - Administration of these regulations shall be the responsibility of the City Engineer, who shall review to determine approval, disapproval, or modification of stormwater management plans as provided herein.

2. Operation and Maintenance of Publicly Owned Facilities - The City Public Works Department shall be responsible after construction for the operation and maintenance of all drainage structures and improved courses which are part of the stormwater runoff management system under public ownership and which are not constructed and maintained by or under the jurisdiction of any state or federal agency.

B. Private Responsibilities:

1. Each developer of land within the City has a responsibility to provide on the developer's property all approved stormwater runoff management facilities to ensure the adequate drainage and control of stormwater on the developer's property both during and after construction of such facilities.

2. Each developer or owner has a responsibility and duty before and after construction to properly operate and maintain any on-site stormwater runoff control facility which has not been accepted for maintenance by the public. Such responsibility is to be transmitted to subsequent owners through appropriate covenants.

ARTICLE 3.

PROCEDURE FOR THE SUBMISSION, REVIEW AND APPROVAL OF STORMWATER MANAGEMENT AND DRAINAGE PLANS.

3.1 General - The stormwater management and drainage plan shall be prepared by the Engineer of Record, who is a licensed professional engineer of the State of Arkansas. No building permits or subdivision approvals shall be issued until and unless the stormwater management and drainage plan has been approved by the City Engineer.

3.2 Pre-Preliminary Drainage Plan Review - A pre-preliminary drainage plan review with the Engineering staff is suggested before preliminary platting for the purpose of overall general drainage concept review.

3.3 Review of Preliminary Stormwater and Drainage Plan - A preliminary stormwater and drainage plan, and accompanying information shall be submitted at the time of preliminary plat submittal. If needed, a review meeting will be scheduled by the City Engineer with representatives

of the developer, including the Engineer of Record, to review the overall concepts included in the preliminary stormwater and drainage plan. The purpose of this review shall be to jointly agree upon an overall stormwater management concept for the proposed development and to review criteria and design parameters which shall apply to final design of the project.

3.4 Final Stormwater Management and Drainage Plan - Following the preliminary stormwater management and drainage plan review, the final stormwater management and drainage plan shall be prepared for each phase of the proposed project as each phase is developed. The final plan shall constitute a refinement of the concepts approved in the preliminary stormwater and drainage plan with preparation and submittal of detailed information as required in the Drainage Manual. This plan shall be submitted at the time construction drawings are submitted for approval. No final plat is to be approved until the drainage structures approved on the construction plans are in place and approved by the City Engineer.

3.5 Review and Approval of Final Stormwater Management and Drainage Plans - Final stormwater management and drainage plans shall be reviewed by the City Engineer. If it is determined according to present engineering practice that the proposed development will provide control of stormwater runoff in accordance with the purposes, design criteria, and performance standards of these regulations and will not be detrimental to the public health, safety and general welfare, the City Engineer shall approve the plan or conditionally approve the plan, setting forth the conditions thereof.

If it is determined that the proposed development will not control stormwater runoff in accordance with these regulations, the City Engineer shall disapprove the final stormwater management and drainage plan.

If disapproved, the application and data shall be returned to the applicant for resubmittal.

(Note: Time frames for filing, review and approval of stormwater management and drainage plans shall coincide with time periods applicable in existing subdivision regulations.)

ARTICLE 4.

DESIGN CRITERIA AND PERFORMANCE STANDARDS

4.1 Design Criteria - The City of Little Rock's Stormwater Management and Drainage Manual shall be the accepted design document. Unless otherwise provided, the following rules shall govern the design and improvements

with respect to managing stormwater runoff:

A. Method of Determining Stormwater Runoff - Developments where the upstream drainage area contributing runoff is less than 200 acres should be designed using the rational method of calculating runoff. Developments where the area contributing runoff is between 200 and 2,000 acres should be designed using the U.S. Soil Conservation Services TR-55 method of calculating runoff. For developments where the area contributing runoff is greater than 2,000 square acres or more, the U.S. Army Corps of Engineers HEC-I program should be used to calculate flows or discharges. The applicant may also submit an alternative hydrograph method of evaluation for the calculation of runoff to the City Engineer for review and approval.

All such development proposals shall be prepared by a licensed professional engineer of the state of Arkansas.

B. Development Design - Streets, lots, depths of lots, parks, and other public grounds shall be located and laid out in such a manner as to minimize the velocity of overland flow, allow maximum opportunity for infiltration of stormwater to the ground, and to preserve and utilize existing and planned streams, channels, extension basins, and include wherever possible, streams and floodplains within parks and other public grounds.

C. Enclosed Systems and Open Channels - Enclosed systems and open channels shall be designed using the City of Little Rock's Stormwater Management and Drainage Design Manual.

D. Evaluation of Downstream Flooding - The Engineer of Record should evaluate whether the proposed plan will cause or increase downstream flooding conditions. This evaluation should be made on the basis of existing downstream development and an analysis of stormwater runoff with and without the proposed development. When it is determined that the proposed development will cause or increase downstream flooding conditions, provisions to minimize such flooding conditions should be included in the design of storm management improvements. Such provisions may include downstream improvements and/or detention of stormwater runoff and its regulated discharge to the downstream storm drainage system.

E. Detention - Developments also shall include temporary detention of stormwater runoff in order to minimize downstream flooding conditions. The following design criteria shall govern the design of temporary drainage facilities:

1. Storage Volume - The volume of storage provided in the detention basin shall be sufficient to

control the differential runoff from the 25-year storm frequency of six-hour duration. The differential runoff is the volume and rate of flow of stormwater runoff discharged from a parcel of land or drainage area which is or will be greater than the volume and rate which pertained prior to proposed development for redevelopment.

2. Freeboard - Detention storage areas shall have adequate capacity to contain the storage volume of tributary stormwater runoff with at least 6 inches of freeboard above the water surface of flow and the emergency spillway in a 25-year storm. The entire structure should be designed for discharging the major storm.

3. Outlet Control Works

(a) Outlet works shall be designed to limit peak out-flow rates from detention storage areas to or below peak flow rates for a 25-year storm that would have occurred prior to the proposed development.

(b) Outlet works shall not include any mechanical components or devices and shall function without requiring attendance or control during operation.

(c) Size and hydraulic characteristics shall be such that all water and detention storage is released to the downstream storm sewer systems within 24 hours after the end of the design rainfall. Normal time for discharge ranges from 3 to 24 hours.

4. Spillway - Emergency spillways shall be provided to permit the safe passage of runoff generated from a 100-year storm or greater, if appropriate because of downstream high hazard, such as loss of life or damage to high value property.

5. Design Data Submittal - In addition to complete plans, all design data shall be submitted as required in the detention design data submittal section of the Drainage Manual.

6. Detention Methods - Depending upon the detention alternative(s) selected by the Engineer of Record, the design criteria for detention ponds shall follow those given in the Drainage Manual.

F. Reductions in Coefficient of Runoff - If an existing site with an existing coefficient of runoff of 1.0 (totally impervious) is developed, no on-site detention or in-lieu fee for detention is required. Also, if an existing site is developed whereby the coefficient of runoff is reduced to a lesser value, no on-site detention or in-lieu fee is required.

G. Alternatives to On-Site Detention

1. Alternative Methods - Where on-site detention is deemed inappropriate due to local topographical or other physical conditions, alternate methods for accommodating increases in stormwater runoff shall be permitted. The methods may include:

(a) Off-site detention or comparable improvements.

(b) In-lieu monetary contributions for channel improvements or off-site detention improvements by the City within the same watershed. Channel improvements shall only be used if they are an integral part of a detailed watershed study.

2. In-Lieu Contributions to Regional or Sub-Regional Detention - An owner may contribute to the construction of a regional or sub-regional detention site constructed or to be constructed in lieu of constructing on-site detention. However, no in-lieu contributions are allowed when existing flooding occurs downstream from the development, or if the development will cause downstream flooding.

3. In-Lieu Fees - The in-lieu fee contribution shall be based upon an amount of \$10,000 per Acre-Foot of stormwater storage.

4. Excess Stormwater Storage Credit - An owner may receive credit for excess stormwater storage (in Acre-Feet) created on one site that may be applied to another site within the same watershed. The transfer of storage volume credit (in Acre-Feet) shall not be allowed if the site where credited storage is proposed to be transferred has an existing flooding condition downstream or the proposed development will produce downstream flooding.

5. Regional or Sub-Regional Detention Sites - The acquisition of regional or sub-regional detention sites and construction of facilities thereon will be financed by the City. Monies contributed by the owners as above provided shall be used for regional and sub-regional detention site studies, land acquisition and facility construction thereof in the watershed in which the development is located.

6. Watershed Boundaries - The boundaries of watersheds and priority of acquisition of regional and sub-regional detention sites in construction of detention facilities and location thereof shall be established by the City Engineer and approved by the Planning Commission.

4.2 Performance Standards

A. Stormwater Channel Location - Generally acceptable locations of stormwater runoff channels in the design of a subdivision may include but not be limited to the following:

1. In a depressed median of a double roadway, street or parkway provided the median is wide enough to permit maximum three (3) to one (1) side slopes.
2. Along the roadway, street or parkway.
3. Located along lot lines or entirely within the rear yards of single row of lots or parcels.
4. In each of the foregoing cases, a drainage easement to facilitate maintenance and design flow shall be provided and shown on the plat. Drainage easement required dimensions are shown in the Drainage Manual and shall conform to the dimensions given. No structures shall be constructed within or across stormwater channels without the approval of the City Engineer.

B. Easements - Drainage easements required to facilitate maintenance, detention and conveyance of stormwater shall be provided and shown on the preliminary and final plat. There are two types of easements that are to be determined by the Engineer of Record and shown on the preliminary final plat. These are:

1. Minor Storm Easements - Easements designed to carry the minor storm (10-year design frequency). The minor storm easements are primarily for carrying flow from the 10-year storm, maintenance access, utility locations, and are to be kept clear of any obstructions.
2. Major Storm Easements - Privately maintained easements designed to carry the major storm (100-year design frequency). The major storm easements shall be kept free of obstructions, such as fill or fences, that would impede the flow of the 100-year design storm. Properly designed landscaping that does not impede the flow of floodwater or endanger adjacent property is acceptable.

C. Storm Sewer Outfall - The storm sewer outfall shall be designed so as to provide adequate protection against downstream erosion and scouring.

D. Lot Lines - Whenever the plans call for the passage and/or storage of floodwater, surface runoff or stormwater along lot lines involving the major storm system, grading of all such lots shall be prescribed and established

for the passage and/or storage of waters, and no structure may be erected which will obstruct the flow of stormwater, no fences, shrubbery, or trees planted, or changes made to the prescribed grades and contours of the specified floodwater or stormwater runoff channels.

E. Manholes - All sanitary sewer manholes constructed in a floodplain or in an area designed for the storage or passage of flood or stormwater, shall be provided with either a watertight manhole cover or be constructed with a rim elevation of a minimum one (1) foot above the high water elevation of the base flood, whichever is applicable to the specific area.

F. Floor Elevations - The floor elevation of any occupied residence or commercial building shall be a minimum of twelve (12") above the land immediately surrounding the building. The minimum floor elevation for a structure located on the uphill side of a street shall be at or above the crown of the adjacent street.

ARTICLE 5.

BONDS, MAINTENANCE ASSURANCES, AND DRAINAGE APPROVALS

5.1 Maintenance Agreement - A maintenance agreement approved by the City Engineer, assuring perpetual maintenance of stormwater management improvements shall be agreed upon by the City and the applicant.

Maintenance of detention ponds (wet type) shall be the responsibility of the owner of record and/or the property owners' association.

Maintenance of detention basins (dry type) shall be the responsibility of the owner of record and/or property owners' association. The City shall have the primary right to remove sediment when the basin's function is impaired. The owner of record and/or property owners' association shall be responsible for all other maintenance, plantings, reseeding, or resodding. The owner shall also be responsible for removing and replacing any landscaping, playground equipment, or other facilities within the basin.

5.2 Maintenance Bond - A one-year maintenance bond against defects in workmanship shall be required by the City Engineer for any portion of the stormwater management improvements dedicated to the public.

5.3 Drainage Permits and/or Approvals - Upon approval of the final stormwater management and drainage plan, and acceptance and the applicant's assurances of performance and maintenance as provided in these regulations, the City

Engineer shall approve the plan. Project approval shall be issued in the name of the applicant who shall then be known and thereafter be referred to as the permittee. An approved permit shall set forth the terms and conditions of the approve stormwater management and drainage plan.

5.4 Engineer of Record - Should the original Engineer of Record be prevented from completing the project, the Permittee shall employ another qualified engineer and notify the City Engineer immediately.

ARTICLE 6.

ENFORCEMENT

6.1 General - It shall be the duty of the City Engineer to bring to the attention of the City Attorney any violation or lack of compliance herewith.

6.2 Violations and Penalties - Any Permittee (person, firm or corporation) who fails to comply with or violates any of these regulations shall be guilty of a misdemeanor and upon conviction thereof shall be fined not less than \$100 per day and not more than \$500 per day.

6.3 Inspection - The City Engineer shall be responsible for determining whether the stormwater management and drainage plan is in conformance with the requirements specified by the City's Stormwater Management and Drainage Manual. Also, the City Engineer shall be responsible for determining whether the development plan is proceeding in accordance with the approved drainage plan. Periodic inspection of the development site shall be made by the City Engineer's office. Through such periodic inspections, the City Engineer's office shall ensure that the stormwater management and drainage plan is properly implemented and that the improvements are maintained.

6.4 Remedial Work - If it is determined through inspection that the development is not proceeding in accordance with the approved stormwater management and drainage plan, and drainage and/or building permit, the City Engineer shall immediately issue written notice to the permittee and the surety of the nature and location of the alleged noncompliance, accompanied by documentary evidence demonstrating noncompliance and specifying what remedial work is necessary to bring the project into compliance. The permittee so notified shall immediately, unless weather conditions or other factors beyond the control of the permittee prevent immediate remedial action, commence the recommended remedial action and shall complete the remedial work within 72 hours or within a reasonable time as determined in advance by the City Engineer. Upon

satisfactory completion of remedial work, the City Engineer shall issue a notice of compliance and the development may proceed.

6.5 Revocation of Permits or Approvals; Stop Orders -
The City Engineer after giving five days written notice, may revoke the permit issued pursuant to the regulations for any project which is found upon inspection to be in violation of the provisions of these regulations, and for which the permittee has not agreed to undertake remedial work as provided in Section 6.4. Drainage and/or building permits may also be revoked if remedial work is not completed within the time allowed. Upon revocation of a permit or approval, the City Engineer shall issue a stop work order. Such stop work order shall be directed to the permittee and he shall immediately notify persons owning the land, developer, and those persons or firms actually performing the physical work of clearing, grading, and developing the land. The stop work order shall direct the parties involved to cease and desist all or any portion of the work on the development for a portion thereof which is not in compliance, except such remedial work necessary to bring the project into compliance.

ARTICLE 7.

GENERAL PROVISIONS

7.1 Interpretation, Conflict and Severability Interpretations

A. Interpretation - In their interpretation and application, the provisions of these regulations shall be held to be the minimum requirements for the promotion of the public health, safety and general welfare.

B. Conflict with Public and Private Provisions - These regulations are not intended to interfere with, abrogate, or annul any other ordinance, rule or regulation, statute or other provision of law. Where any provision of these regulations imposes restrictions different from those imposed by any other provision of these regulations or any other ordinance, rule or regulation, or other provision of law, whichever provisions are more restrictive or impose higher standards, shall control.

Private Provisions - These regulations are not intended to abrogate any easement, covenant or any other private agreement or restriction, provided that where the provisions of these regulations are more restrictive or impose higher standards or regulations that such easement, covenant or other private agreement or restriction, the requirements of these regulations shall govern. Where the provisions of the

easement, covenant or private agreement or restriction imposed duties and obligations more restrictive, or higher standards than the requirements of these regulations, and such private provisions are inconsistent with these regulations or determinations thereunder, then such private provisions shall be operative and supplemental to these regulations and determinations made hereunder.

C. Severability - If any part of provision of these regulations or application thereof to any person or circumstances is adjudged invalid by any court of competent jurisdiction, such judgment shall be confined in its operation to that part, provision, or application directly involved in the controversy in which such judgment shall have been rendered and shall not affect or impair the validity of the remainder of these regulations or the application hereof to other persons or circumstances. The governing body hereby declares that it would have enacted the remainder of these regulations even without any such part, provision or application found to be unlawful or invalid.

7.2 Saving Provision - These regulations shall not be construed as abating any action now pending under, or by virtue of, prior existing regulations, or as discontinuing, abating, modifying, or altering any penalty accruing or about to accrue, or as effecting the liability of any person, firm or corporation, or as waiving any right to the City under any section or provision existing at the time of adoption of these regulations, or as vacating or annulling any rights obtained by any person, firm, or corporation by lawful action of the City, except as shall be expressly provided for in these regulations.

7.3 Amendments - For the purpose of providing for the public health, safety and general welfare, the governing body may, from time to time, amend the provisions of these regulations. The Public Works Department has the responsibility for updating on a continuing basis, the Drainage Manual.

7.4 Appeals - Any persons aggrieved by a decision of the City Engineer may appeal any order, requirement, decision, or determination to the Planning Commission. The next step in the process would be to a court of competent jurisdiction in accordance with the laws of Pulaski County and the state of Arkansas.

ARTICLE 8.

LIABILITY

8.1 Disclaimer of Liability - The performance standards and design criteria set forth herein and in the Drainage

Manual establish minimum requirements which must be implemented with good engineering practice and workmanship. Use of the requirements contained herein shall not constitute a representation, guarantee, or warranty of any kind by the City, or its officers and employees of the adequacy or safety of any stormwater management structure or use of the land. Nor shall the approval of the stormwater management and drainage plan imply that the land uses permitted will be free from damages caused by stormwater runoff. The degree of protection required by these regulations is considered reasonable for regulatory purposes and is based on historical records, engineering and scientific methods of study. Larger storms may occur or stormwater runoff heights may be increased by man-made or natural causes. These regulations, therefore, shall not create liability on the part of the City or any officer or employee with respect to any legislative or administrative decision lawfully made hereunder.

PASSED: December 4, 1984

ATTEST: Jane Czech
City Clerk

APPROVED: J. W. Benafield
Mayor

STORMWATER MANAGEMENT & DRAINAGE DESIGN MANUAL

POLICIES

STORMWATER MANAGEMENT & DRAINAGE DESIGN MANUAL

INTRODUCTION

INTRODUCTION

Recognizing that properly designed storm sewer systems are essential to the general public health and welfare within a metropolitan area as the City of Little Rock, the City hereby adopts the following criteria for standard procedures in storm sewer drainage. This criteria is intended to serve as a guide for the development of the design all inlets, catch basins, manholes, sewers, open channels and creeks, culverts or other hydraulic appurtenances. The criteria shall not be limited to design of new facilities but shall also apply to the upgrading of existing facilities necessitated by inadequate capacity.

Because storm drainage design is a widely variable process subject to situations and conditions beyond the control of the design engineer, cases will undoubtedly occur in which this criteria is not universally applicable. The applicability or nonapplicability of any part of this criteria to a particular case will be decided by the City Engineer, and the design engineer shall abide by that decision. Each case, where a variance from the criteria is desired or considered appropriate, shall be brought to the City Engineer's attention and a decision obtained prior to proceeding with design.

SECTION 1 - SUBMITTAL PROCEDURES

1.1 General

1.2 Title Sheet

1.3 General Layout Sheet

SECTION I - SUBMITTAL PROCEDURES

1.1 GENERAL



















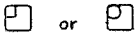

In order to minimize review time by the City Engineer's staff, three sets of plans for the proposed improvements should be submitted the following format where pertinent, shall include: (1) title sheet, (2) general layout sheet, (3) right-of-way sheet, (4) quantity summary sheet, (5) plan and profile sheet(s), (6) standard and special detail sheets, (7) mapping, and (8) calculations. Combining of the above items is allowed when legibility and readability is maintained.

The word "improvement" is used to convey plans for roadway-drainage construction as well as for plans pertaining to the construction of drainage improvements only.

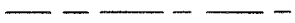
On combination roadway-drainage projects, it is not the intent that completely separate storm drainage plans be prepared. Where the required details of the proposed storm drainage system can be adequately shown on the roadway plans without sacrificing clarity, the roadway plans will be sufficient. If a combined project submittal is made for review of only roadway or only storm drainage aspects of the project, this fact shall be clearly indicated in large, bold lettering on the Title Sheet.

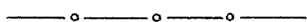
Plans and specifications for storm drainage plans are to be signed by a professional engineer registered in the state of Arkansas. Because all plans, specifications and calculations are retained by the City for use as permanent records, neatness, clarity and completeness are very important and lack of these qualities will be considered sufficient basis for submittal rejection. The topographic symbols and abbreviations shown on Figure 1-1 shall be used on all plans.

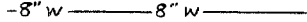
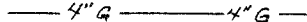
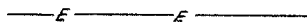
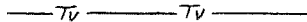
The suggested plan sheet size is 24" x 36" with all sheets in a given set of plans the same size. Plan drawings shall be prepared with a maximum horizontal scale of 1" = 100'. Profile drawings for storm sewers should be drawn to a suggested horizontal scale of 1" = 20' with a maximum scale of 1" = 50'; and a minimum vertical scale of 1" = 5'. Drainage ditch profile should be drawn at the suggested horizontal scale of 1" = 20' with a maximum scale of 1" = 50'; and a minimum vertical scale of 1" = 5'. Special cases may warrant use of larger or smaller scale drawings for increased clarity or conciseness of the plans and may be used with prior permission of the City Engineer.

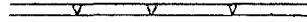
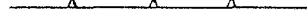
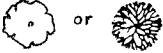
	M.H.	Manhole
	W.M.	Water Meter
	P.P.	Power Pole
	T.P.	Telephone Pole
		Other Pole (Specify)
	F.H.	Fire Hydrant
	W.V.	Water Valve
	G.V.	Gas Valve
	G.R.	Gas Riser
	Gr. In.	Grate Inlet (if req'd. State Type)
		New Catch Basin w/48" Standard Inlet
		Existing Catch Basin w/Standard Inlet
	J.B.	Junction Box w/Manway
		Guy Anchor
		Existing Reinforced Concrete Pipe
	R.C.P.-C.M.P. C.M.P.A.	New Reinforced Concrete or Asbestos Bonded Corrugated Metal Pipe (or Arch) (Specify Size)
	B.C.	Back of Street Curb
	Wr. Fe.	Wire Fence (Specify Type & Height)
	C.L. Fe.	Chain Link Fence (Specify Height)
		Drainage Thread
		Sanitary Sewer Main (Specify Size)
		Water Main (Specify Size)
		Gas Main (Specify Size)
		Electrical
		Cable Television
		Existing Concrete Slab
		Ditch (Specify Dirt or Concrete)
		Ditch (Specify Dirt or Concrete)
		Tree (Specify Size & Kind)

Each sheet in a set of plans shall contain a sheet number, the total number of sheets in the plans, proper project identification and the date. Revised sheets submitted contain a revision block with identifying notations and dates for revisions.

1.2 TITLE SHEET

Title shall include:

1. The designation of the project which includes the nature of the project, the name or title, city, and state.
2. Project number.
3. Index of sheets.
4. Location maps showing project location in relation to streets, railroads, and physical features. The location map shall have a north arrow and appropriate scale.
5. A project control bench mark identified as to the location and elevation. Elevation shall be based on National Geodetic Vertical Datum (N.G.V.D.).
6. The name and address of the owner of the project and the engineer preparing the plans.
7. Engineer's seal.

1.3 GENERAL LAYOUT SHEET

The general layout sheet shall include:

1. North arrow and scale.
2. Legend of symbols which will apply to all sheets. (See List of Standard Symbols, Figure 1-1.)
3. Name of subdivision and all street names and an accurate tie to at least one quarter section corner. Unplatted tracts should have an accurate tie to at least one quarter section corner.
4. Boundary line or project area.
5. Location and description of existing major drainage facilities within or adjacent to the project area.
6. Location of major proposed drainage facilities.

7. Name of each utility within or adjacent to the project area.
8. If more than one general layout sheet is required, a match line should be used to show continuation of coverage from one sheet to the next sheet.
9. The registration seal of the Engineer of Record shall be placed in a convenient place in the lower right-hand corner of each sheet of plans.
10. Elevations on profiles of sections or as indicated on plans shall have U.S.G.S. data. At least one permanent bench marks in the vicinity of each project shall be noted on the first drawing of each project, and their location and elevation shall be clearly defined.
11. The top of each page shall be either north or east. The stationing of street plans and profiles shall be from left to right.
12. Each project shall show at least 20' of topography on each side. At least 50' of topography shall be shown in areas of channel flow at the property boundary. All existing topography and any proposed changes, including utilities, telephone installations, etc., shall be shown on the plans and profiles.
13. Revisions to drawings shall be indicated above the title block in a revision and shall show the nature of the revision and the date made.
14. Utilizing the standard symbols for engineering plans, all existing utilities, telephone installations, sanitary and storm sewers, pavements, curbs, inlets and culverts, etc., shall be shown with a broken line; proposed facilities with a solid line; land, lot, and property lines to be shown with a slightly lighter solid line. Easement shall be shown.
15. Lot lines and dimensions shall be shown where applicable.
16. Minimum floor elevation shall be shown on each lot when located in a designated floodplain and in areas where flooding is known to occur. All occupied building, whether in or out of a designated floodplain shall have the finished floor elevation a minimum of 12" above the land immediately surrounding the building.
17. It shall be understood that the requirements outlined in these standards are only minimum requirements and shall only be applied when conditions, design criteria,

and materials conform to the City specifications and are normal and acceptable to the City Engineer. When unusual subsoil or drainage conditions are suspected, an investigation should be made and a special design prepared in line with good engineering practice.

SECTION II - DETERMINATION OF STORM RUNOFF

2.1 General

2.2 City of Little Rock Drainage Methods

2.3 Rational Method

2.3.1 Runoff Coefficient "C"

2.3.2 Soil

2.3.3 Selection of Runoff Coefficient

2.3.4 Rainfall Intensity "I"

2.3.5 Time of Concentration

2.3.6 Channelized Flow

2.3.7 Design Intensity

2.3.8 Drainage Area "A"

2.4 Soil Conservation Service Method, Tabular TR-55

2.4.1 General

2.4.2 Method Fundamentals

2.4.3 Limitations on Tabular Method Use

2.4.4 Tabular Method Used

2.4.4.1 Determination of Runoff Curve Number (RCN)

2.4.4.2 Design Storm Data

2.4.4.3 Direct Runoff Amounts from Design Storms (DRO Values)

2.4.5 Hydrograph Distribution Selections

2.4.6 Manipulation and Recording Data

2.4.7 Tabular Hydrograph Applications

2.5 HECI/HECII

SECTION - II DETERMINATION OF STORM RUNOFF

2.1 GENERAL

Continuous records over many years on the amounts and rates of runoff from the City's streams would provide the best source of data on which to base the design of storm drainage and flood protection systems. Unfortunately, stream flow records of adequate history are not available for the majority of the City's drainageways. Experience-based prediction of the probable frequencies and amounts of runoff is not available as a standard practice in determining stormwater runoff and flood flows.

The accepted practice, therefore, is to relate runoffs to rainfall events; events which enjoy a very lengthy period of record. The correlation of the rainfall events to runoff amounts is a widely accepted practice. Direct correlation provides a means for predicting the rates and amounts of runoff expected from the City's watersheds at various recurrence intervals since runoff events are directly based on known frequency of occurrence for various rainfall events.

In order to increase needed engineering data and monitor and validate actual runoff, the City of Little Rock shall develop and implement a stream gaging program on large and small developing watersheds as a continuing program.

2.2 CITY OF LITTLE ROCK DRAINAGE METHODS

There are numerous methods of rainfall computations on which the design of storm drainage and flood control systems are based. Three widely used methods include: the Rational Method, the Soil Conservation Service Technical Release - 55 Synthetic Hydrograph Method, and the Corps of Engineers HEC I/HEC II computer programs or a method authorized by the Little Rock Office of the Corps of Engineers. One of these three methods should be the basis of all drainage analysis in the City of Little Rock. However, the City Engineer may approve other engineering methods of analysis for calculation of stormwater runoff when they are shown to be comparable to the required methods. The recommended area limits and/or ranges for the analysis methods are:

Rational Method	200 Acres or Less
SCS TR-55 Hydrograph Method	200 to 2000 Acres
HEC I/HEC II Computer Methods or other Corps of Engineers' authorized methods	Greater than 2000 Acres or within Designated Floodplain Areas

Criteria for the above three methods are specified in the following sections.

2.3 RATIONAL METHOD

The Rational Method is probably the most frequently used rainfall-runoff method in urban hydrology in the United States. The rational method formula is expressed as:

$$Q = C (I) (A)$$

"Q" is defined as the peak rate of runoff in cubic feet per second. Actually, Q is in units of inches - acres per acre, but calculator results differ from cubic feet by less than 1 percent. Since the difference is so small, the "Q" value calculated by the equation is universally taken as cubic feet per second or "CFS."

"C" is the dimensionless coefficient of runoff represented in the ratio of the amount of runoff to the amount of rainfall.

"I" is the average intensity of rainfall in inches per hour for a period of time equal to the critical time of full contribution of the drainage area under consideration. This critical time for full contribution is commonly referred to as "time of concentration."

"A" is the area in acres that contributes to runoff at the point of design or the point under consideration.

Basic assumptions associated with use of the rational method are as follows:

1. The computed peak rate of runoff to the design point is the function of the average rainfall rate during the time of concentration to that point.
2. The time of concentration is the critical value in determining the design rainfall intensity.
3. The ratio of runoff to rainfall, "C," is uniform during the entire duration of the storm event.
4. The rate of rainfall or rainfall intensity, "I," is uniform for the entire duration of the storm event and is uniformly distributed over the entire watershed area.

2.3.1 RUNOFF COEFFICIENT ("C")

The proportion of the total rainfall that runs off depends on the relative porosity or imperviousness of the ground

surface, the surface slope, and the ponding character of the surface. Impervious surfaces, such as asphalt pavements and roofs of buildings, will be subject to nearly 100 percent runoff regardless of the slope, after the surfaces have become thoroughly wet. On-site inspections and aerial photographs are valuable in estimating the nature of the surfaces within the drainage area.

2.3.2 SOIL

The runoff coefficient "C" in the rational formula is also dependent on the character of the soil. The type and condition of the soil determines its ability to absorb precipitation. The rate at which a soil absorbs precipitation generally decreases if the rainfall continues for an extended period of time. The soil absorption or infiltration rate is also influenced by the presence of soil moisture before a rain (antecedent condition), the rainfall intensity, the proximity of the ground water table, the degree of soil compaction the porosity of the subsoil, vegetation, ground slopes, and surface depressions.

2.3.3 SELECTION OF RUNOFF COEFFICIENTS

It should be noted that the runoff coefficient "C" is the variable of the rational method which is least susceptible to precise determination. Proper selection requires judgment and experience on the part of the engineer, and its use in the formula implies a fixed ratio for any given drainage area, which in reality is not the case. A reasonable coefficient must be chosen to represent the integrated effects of infiltration, detention storage, evaporation, retention, flow routing, and interception, all of which effect the time distribution and peak rate of runoff.

Table 2.1 and Table 2.2 present standard runoff coefficient values by land use and composite analysis. These values for respective land uses shall govern for all drainage analysis and design projects by the Rational Method.

The City of Little Rock is divided into three design zones according to soil types and terrain as shown in Figure 2.1. These zones shall govern selection of runoff coefficients according to land use types. Table 2.3 presents standard runoff coefficient values by land use types using the SCS tabular for the City's three design zones. The values for respective land uses within each zone shall govern for all drainage analysis and design projects by the SCS tabular method.

TABLE 2.1 RUNOFF COEFFICIENTS FOR RATIONAL METHOD

LAND USE TYPES	RUNOFF COEFFICIENTS		
	10	25	100
<u>Business:</u>			
Central Business District	.90	.93	.95
Commercial Area	.85(.70-.95)*	.90	.95
Neighborhood Area	.70(.50-.75)	.75	.80
<u>Residential:</u>			
Single Family	.50(.30-.60)	.60	.70
Multi-Unit (Detached)	.60(.40-.65)	.65	.75
Multi-Unit (Attached)	.70(.60-.75)	.75	.80
1/2 AC Lots or Larger	.40(.25-.50)	.45	.65
Apartments	.70(.50-.80)	.75	.80
<u>Industrial:</u>			
Light Areas	.80(.50-.85)	.82	.85
Heavy Areas	.85(.60-.90)	.87	.90
<u>Parks and Cemeteries</u>	.30(.10-.40)	.40	.60
<u>Playgrounds</u>	.35(.20-.40)	.50	.70
<u>Schools and Churches</u>	.60(.50-.75)	.65	.75
<u>Railroad Yards</u>	.50(.30-.60)	.60	.70
<u>Offsite Flow Analysis (When Land Use Not Defined)</u>	.55(.45-.65)	.67	.70

*NOTE: The range of runoff coefficients based on soil type: The low value is for sandy soils, while the high value is for clay soils. The given runoff coefficient outside the parenthesis is to be used for design, unless the Engineer of Record receives approval from the City Engineer for another value located within the given coefficient range.

TABLE 2.2 RUNOFF COEFFICIENTS FOR RATIONAL METHOD COMPOSITE ANALYSIS

CHARACTER OF SURFACE	RUNOFF COEFFICIENTS		
	FREQUENCY		
	10	25	100
<u>Undeveloped Areas:</u>			
Historic Flow Analysis, Greenbelts, Agricultural, Natural Vegetation			
Clay Soil			
Flat, 2%	.30	.33	.37
Average, 2-7%	.40	.44	.50
Steep 7%	.50	.55	.62
Sandy Soil			
Flat, 2%	.12	.13	.15
Average, 2-7%	.20	.22	.25
Steep 7%	.30	.33	.37
<u>Streets:</u>			
Paved	.90	.92	.95
Gravel	.35	.50	.65
<u>Drives and Walks:</u>			
	.90	.91	.92
<u>Roofs:</u>			
	.90	.92	.95
<u>Lawns:</u>			
Clay Soil			
Flat, 2%	.18	.20	.25
Average, 2-7%	.22	.28	.35
Steep, 7%	.35	.45	.60
Sandy Soil			
Flat, 2%	.10	.25	.40
Average, 2-7%	.15	.30	.45
Steep, 7%	.20	.35	.50

TABLE: 2-3
 TR-55 RUNOFF CURVE NUMBERS
 BY ZONE AND LAND USE

<u>Land Use Description</u>	<u>RCN Values</u>		
	<u>Zone 1</u>	<u>Zone 2</u>	<u>Zone 3</u>
Paved Areas, Roofs & Driveways	98	98	98
Residential (1 Acre Lot)	84	68	79
Residential (1/2 Acre Lot)	85	70	80
Residential (1/3 Acre Lot)	86	72	81
Residential (1/4 Acre Lot)	87	75	83
Residential (1/8 Acre Lots & Multi-family)	92	85	90
Industrial Districts (72% Impervious)	93	88	91
Commercial & Business (85% Impervious)	95	92	94
Forest, Good Cover	77	55	70
Forest, Poor Cover	83	66	77
Wood Lot, Thin Stand	83	66	77
Pasture, Good Condition	80	61	74
Pasture, Poor Condition	89	79	86

Note: Minimum RCN Value for New Residential Developments = 70

Source: U.S. Soil Conservation Service, Tech. Release #55
 Modern Sewer Design, American Iron & Steel Institute

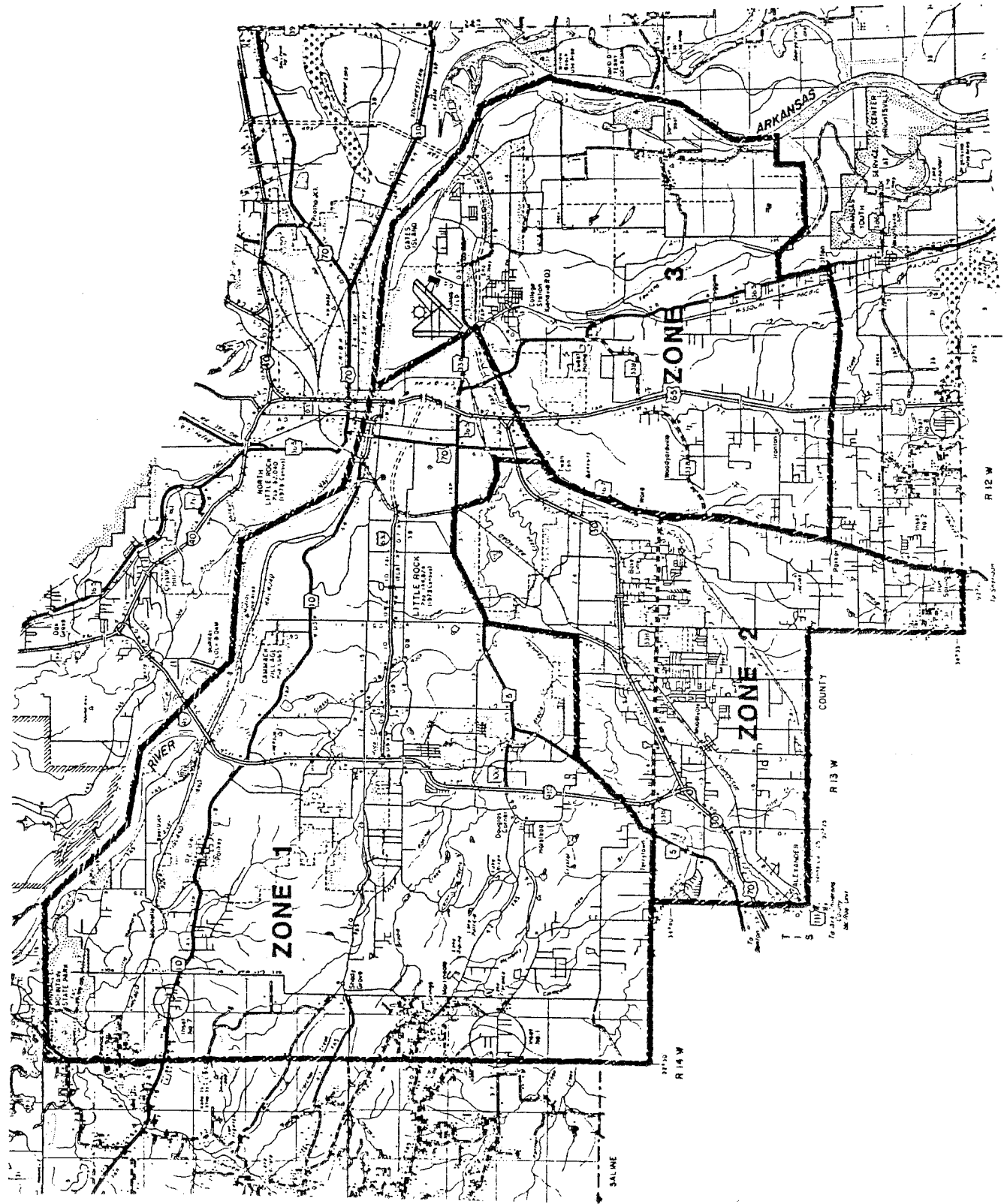
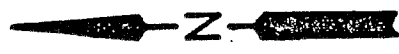

ZONE MAP FOR RUNOFF POTENTIALS

2.3.4 RAINFALL INTENSITY ("I")

Rainfall intensity is the design rainfall rate in inches per hour for a particular drainage basin or subbasin. The rainfall intensity is selected on the basis of the design rainfall duration and frequency of occurrence. The design duration is equal to the time of concentration for a drainage area under consideration. Once the time of concentration is known, the design intensity of rainfall may be determined from the rainfall intensity curves. The frequency of occurrence is a statistical variable which may be established by City standards or chosen by the engineer as a design parameter.

2.3.5 TIME OF CONCENTRATION

The time of concentration used in the rational method is a measure of the time of travel required for runoff to reach the design point or the point under consideration. The critical time of concentration is the time to the peak of the runoff hydrograph at the design point. Runoff from a watershed usually reaches a peak at the time when the entire watershed area is contributing to flow. The critical time of concentration, therefore, is the flow time measured from the most remote part of the watershed to the design point. A trial and error procedure is usually required to select a most remote point of a watershed since type of flow, ground slopes, soil types, surface treatments and improved conveyances all effect flow velocity and time of flow. There are two types of flow used in calculating the design time of concentration; overland flow and channelized flow. Overland flow is defined as that portion of the flow pattern which results in thin sheet flow across a given area. Channelized flow is that which allows significant depth accumulation either in a swale, ditch, natural channel, improved channel or pipe system.

Figure 2-2 or Figure 2-3, depending upon which method is being used for analysis, shall be used for all overland flow computations. The known ground slope plus the type of surface treatment is used to determine the average flow velocity in feet per second. Interpolation can be used for estimating velocities for surface treatments other than those shown. Overland flow distances will rarely exceed 400 feet in developed areas. If the overland flow time is calculated to be in excess of 20 minutes, the designer should check to be sure that the time is reasonable considering the projected ultimate development of the area.

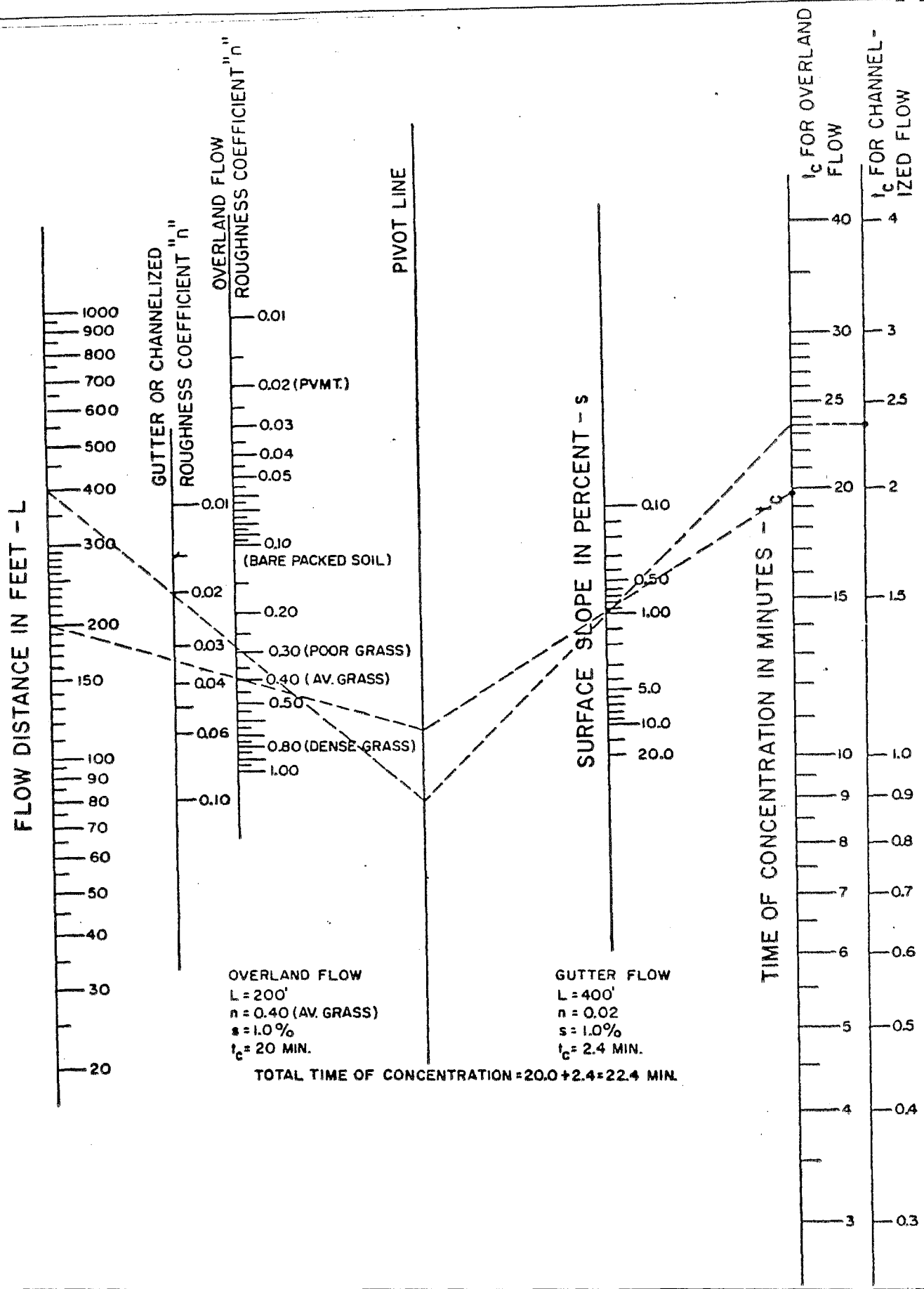

NOMOGRAPH FOR TIME OF CONCENTRATION

SOURCE: City of Fort Worth, Tx.

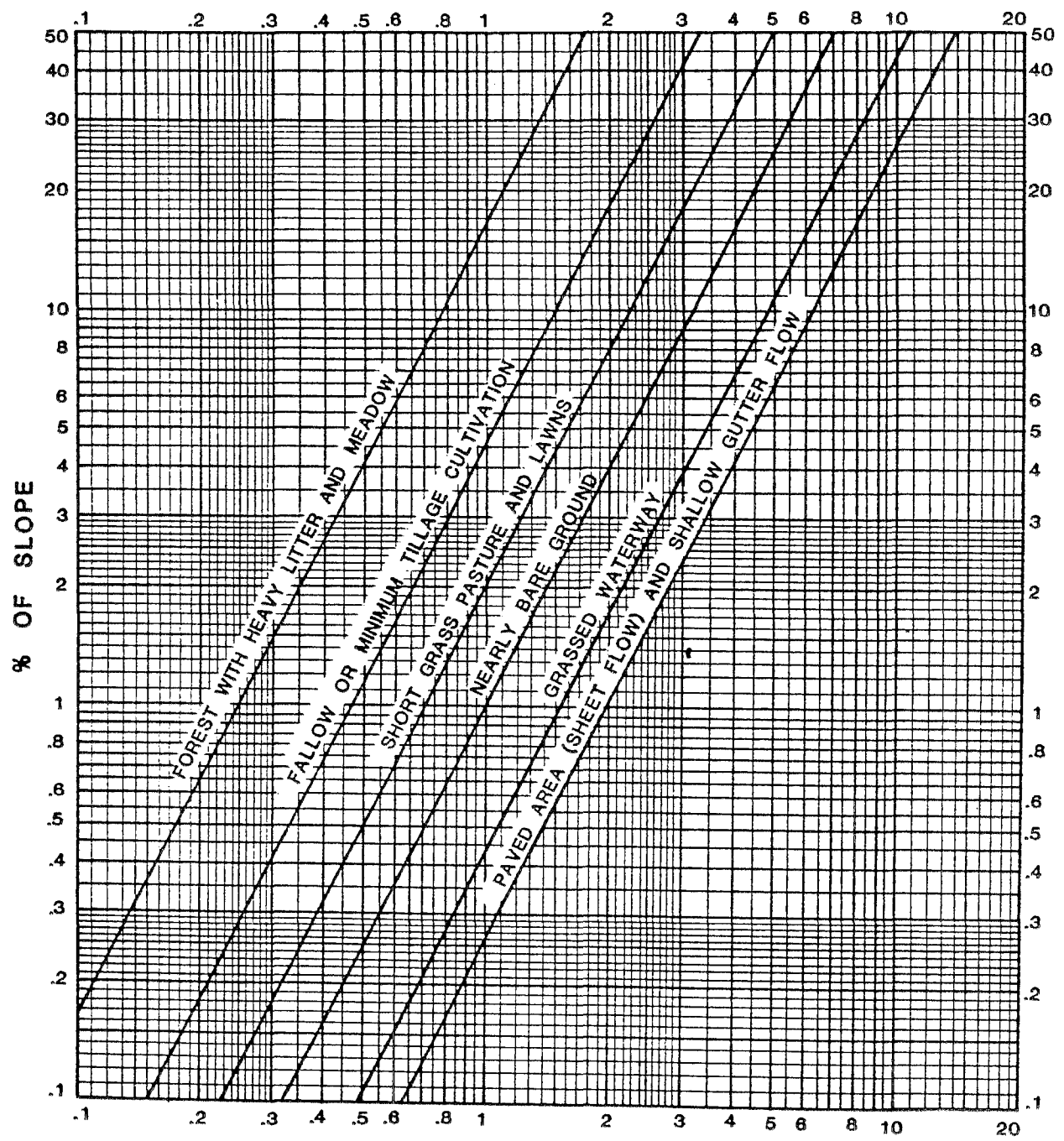

WATERCOURSE SLOPE IN PERCENT

VELOCITY IN FEET PER SECOND

SOURCE: U.S. SOIL CONSERVATION SERVICE. TECHNICAL RELEASE #55



AVERAGE VELOCITIES FOR OVERLAND FLOW

2.3.6 CHANNELIZED FLOW

Channelized flow is that part of the flow pattern which is not shallow, sheet-type flow. Channelized flow paths may consist of pipe systems, natural channels, ditches, swales, and improved ditches in any combination.

2.3.7 DESIGN INTENSITY

The design rainfall intensity can be obtained from either Figure 2-4 or Figure 2-5. Figure 2-3 provides intensity data for the 2, 5, 10, 25, 50 and 100-year return periods for durations up to 24 hours. Figure 2-5 is a reproduction of the data of Figure 2-4 for storm durations of from 5 to 60 minutes. Figure 2-5 will normally be the source of intensity data for use with the Rational Method. If a watershed involves a design time of concentration (storm duration) of over 30 minutes, applicability of the Rational Method should be checked according to the criteria of Section 2.

The calculated time of concentration for the watershed is taken as the duration of the rainfall event required to produce peak runoff at the design point. This relation and the rational formula state that the rate of runoff is equal to the rate of supply (rainfall excess) if the rainfall event lasts long enough to permit the entire watershed to contribute. These assumptions may not involve serious errors for watersheds several acres in size. However, serious errors may be involved for larger watersheds with complex runoff patterns and significant channel and overland flow storage effects.

2.3.8 DRAINAGE AREA (A)

The drainage area or the area from which runoff is to be estimated is measured in acres when using the Rational Method. Drainage areas should be calculated using planimetric-topographic maps, supplemented by field surveys where topographic data has changed or where the contour interval is too great to distinguish the exact direction of overland flows.

2.4 SOIL CONSERVATION SERVICE METHOD, TABULAR TR-55

2.4.1 GENERAL

The soil conservation service tabular method is a synthetic hydrograph method developed specifically for use in urbanized and urbanizing areas. The method is similar to the Rational Method in that runoff is directly related to

INTENSITY - DURATION - FREQUENCY

LITTLE ROCK

SOURCE: HYDRO 35 & T.P. No. 40

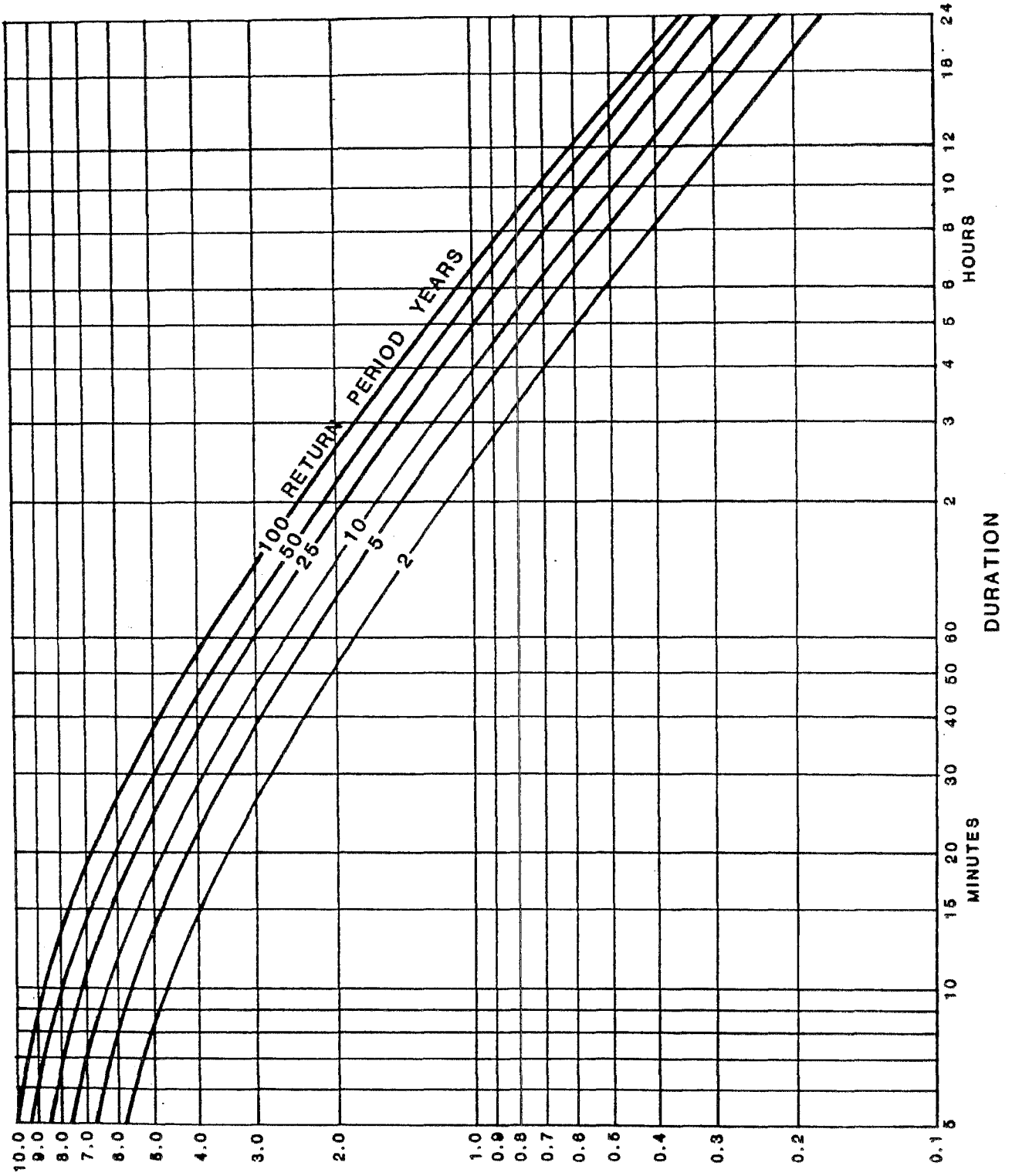

RAINFALL INTENSITY IN INCHES PER HOUR

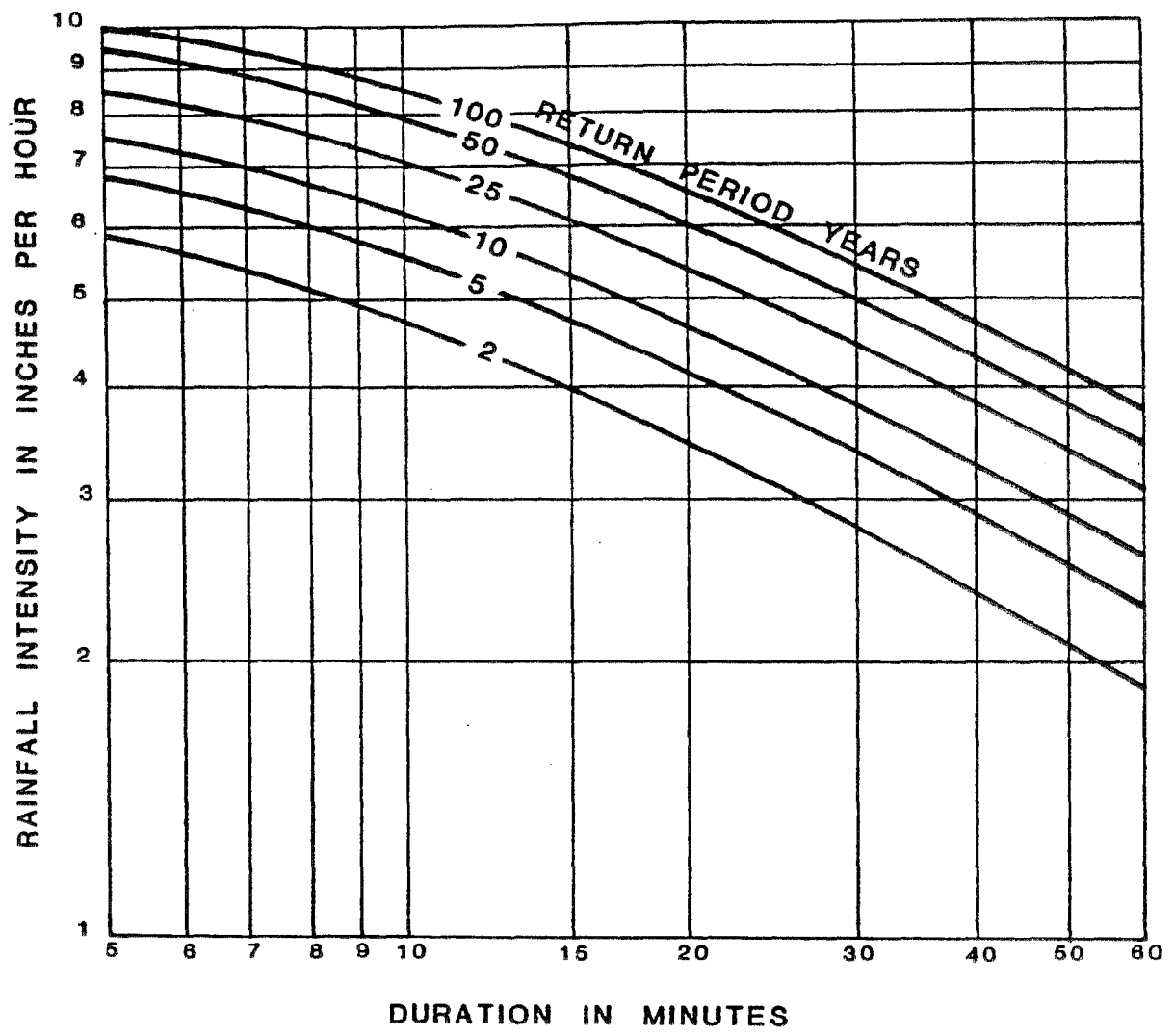

INTENSITY - DURATION - FREQUENCY

LITTLE ROCK

SOURCE : HYDRO 35 & T.P. No. 40

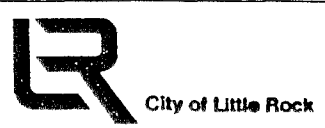

rainfall amounts through use of runoff curve numbers (RCN's). The basic equation used with the tabular method is also very similar to that used for the rational method:

$$q = (DRO) \times (DA) \times (HDO)$$

q = Hydrograph coordinate discharge in CFS
 DRO = Direct runoff amount in inches
 DA = Drainage area in square miles
 HDO = Hydrograph distribution ordinate in CSM/inch
 CSM/inch = Cubic feet per second per square mile per inch of runoff

Hydrograph coordinates are computed from the hydrograph distribution data in the appendix. A coordinated value is computed for each time shown in the distribution data. The calculated "q" results, when plotted against the corresponding times, constitute the runoff hydrograph.

The tabular method is useful in analyzing watersheds involving several subareas with complex runoff patterns. The method is most useful in analyzing changes in runoff volume due to development and in evaluating runoff control measures. The SCS tabular method as described herein shall be used in all cases where watershed problems involving two or more interacting subareas and should be used where any one subarea is more than 30 acres in size. The SCS tabular method is the suggested method to be used in evaluating the runoff effects of urbanization and in evaluation/design of runoff control measures.

2.4.2 METHOD FUNDAMENTALS

The Soil Conservation Service has completed extensive research in the runoff potential from native soils under specific conditions of pre-wetting and rainfall events. This research has also extended to correlation of native soil types and land uses in assessing runoff potential. Runoff curve number or RCN values have been developed which approximate the runoff potential from various types of developments with respect to native soils. These RCN values are similar to runoff coefficient values used in the rational method in that they can be used to estimate the amount of rainfall which will actually result in runoff. The amount of runoff which will occur for a given RCN value is a function of the design rainfall, and is termed direct runoff amount (DRO). The RCN values differ from runoff coefficients in that:

1. Their development encompasses a wide range of land uses.

2. Runoff potentials from native soil types are taken into account.
3. The amount of runoff which will occur is the function of both the RCN value and the design rainfall.

Design rainfalls used with a tabular method are 24-hour rainfall amounts taken from the U.S. Weather Bureau data. The data includes recurrence intervals or frequencies of occurrence of 10, 25, 50 and 100 years.

Hydrograph distribution ordinates used in the tabular method were developed by computer analysis of many watersheds of various sizes and configurations. The distribution data published in Technical Release No. 55 was developed specifically by computing hydrographs for a one square mile drainage area for a range of times of concentration and routing of the hydrographs through stream reaches with a range of travel times. Note that the distribution data and the Technical Release No. 55 publication is not the distribution data specified for use in this manual. The data contained in the appendix were developed from different watershed size ranges and were obtained from the National Engineering Handbook. The distributions contained in the appendix have been determined through local use to produce better comparisons with more advanced methods than the distributions contained in Technical Release No. 55.

One advantage of using the empirically-based hydrograph distribution over simpler methods is that the channel storage and overland flow storage effects are taken into account. This feature is particularly useful in the cases involving larger, more complex watersheds.

The biggest advantage of the tabular method over simpler methods is that the runoff effects of different development patterns (both in land use and in drainage facilities) can be easily measured. The effects of a widened variety of runoff control measures can also be measured since the method's work result is in hydrograph form. These features are extremely valuable in watershed management efforts since differences in flow magnitudes are often more important in design decisions than are determinations of precise peak flow values for given conditions. The tabular method's utility with manual or computer use is a big advantage in watershed management over the HEC I/HEC II method since a wide variety of watershed conditions, drainage development patterns, and runoff control measures can be more easily evaluated.

2.4.3 LIMITATIONS ON TABULAR METHOD USE

The tabular method should not be used when large changes in RCN values occur among watershed subareas and when runoff volumes are less than about 1 1/2 inches for RCN values less than 60. These constraints will not exist for the majority drainage work within the City of Little Rock urban area. They could, however, apply to existing condition analysis and certain semi-urban fringe areas of the City.

The hydrograph distributions contained in the appendix cover times of concentration up to 8 hours and travel times of up to 30 hours. These distributions are generally adequate to analyze watershed subareas ranging up to approximately 6 square miles in size. Any number of watershed subareas of this size can be analyzed as long as the total travel time to the point under consideration does not exceed 30 hours. Additional distributions for times of concentration up to 12 hours are available from the National Engineering Handbook. These additional distributions will allow analysis of larger subareas, subject to the total travel time limitation of 30 hours.

The tabular method should not be used for watersheds that have several subareas with times of concentration below six minutes. In these cases, subareas should be combined so as to produce a time of concentration of at least six minutes (0.10 hours) for the combined areas.

2.4.4 TABULAR METHOD USED

2.4.4.1 DETERMINATION OF RUNOFF CURVE NUMBER (RCN)

The runoff curve number determines the amount of runoff that will occur with the given rainfall. Soil types and land use determines the runoff potential. The City is divided into three design zones as shown in Figure 2-1. These zones are based on extensive soil research by the Soil Conservation Service and broad grouping of native soil types according to runoff potential under seasonal flood antecedent conditions. The zones are in addition set with respect to types of terrain.

Calculation of the RCN values for a watershed or a watershed or subarea proceeds in the same fashion as the calculation of weighted runoff coefficients used in the Rational Method. Area calculations are completed for each land use type within the study area. Table 2-3 lists runoff curve numbers for various land uses according to the design zones of Figure 2-1. These values are used along with the area calculations to arrive at a weighted runoff curve number for the watershed or subarea under consideration. Figure 2-6 is a worksheet which is useful in tabulating weighted runoff curve numbers for watersheds and watershed subareas. Areas

RUNOFF CURVE NUMBER WORKSHEET

Subbasin _____

LAND USE

LAND USE	RCN	ACRES	RCN X ACRES
TOTALS			

WEIGHTED RCN = $\frac{\text{Total (RCN x Acres)}}{\text{TOTAL ACRES}}$ =

Rainfall (inches)	Curve Number (CN) ^{1/}								
	60	65	70	75	80	85	90	95	98
1.0	0	0	0	0.03	0.08	0.17	0.32	.56	.79
1.2	0	0	0.03	0.07	0.15	0.28	0.46	.74	.99
1.4	0	0.02	0.06	0.13	0.24	0.39	0.61	.92	1.18
1.6	0.01	0.05	0.11	0.20	0.34	0.52	0.76	1.11	1.38
1.8	0.03	0.09	0.17	0.29	0.44	0.65	0.93	1.29	1.58
2.0	0.06	0.14	0.24	0.38	0.56	0.80	1.09	1.48	1.77
2.5	0.17	0.30	0.46	0.65	0.89	1.18	1.53	1.96	2.27
3.0	0.33	0.51	0.72	0.96	1.25	1.59	1.98	2.45	2.78
4.0	0.76	1.03	1.33	1.67	2.04	2.46	2.92	3.43	3.77
5.0	1.30	1.65	2.04	2.45	2.89	3.37	3.88	4.42	4.76
6.0	1.92	2.35	2.80	3.28	3.78	4.31	4.85	5.41	5.76
7.0	2.60	3.10	3.62	4.15	4.69	5.26	5.82	6.41	6.76
8.0	3.33	3.90	4.47	5.04	5.62	6.22	6.81	7.40	7.76
9.0	4.10	4.72	5.34	5.95	6.57	7.19	7.79	8.40	8.76
10.0	4.90	5.57	6.23	6.88	7.52	8.16	8.78	9.40	9.76
11.0	5.72	6.44	7.13	7.82	8.48	9.14	9.77	10.39	10.76
12.0	6.56	7.32	8.05	8.76	9.45	10.12	10.76	11.39	11.76

^{1/} To obtain runoff depths for CN's and other rainfall amounts not shown in this table, use an arithmetic interpolation.

TABLE: 2-4

DIRECT RUNOFF VALUES BY RCN'S & RAINFALL AMOUNTS

**SOURCE: U.S. SOIL CONSERVATION SERVICE
TECHNICAL RELEASE #55**

RUNOFF INCHES

<u>RCN #</u>	<u>10 YR.</u>	<u>25 YR.</u>	<u>50 YR.</u>	<u>100 YR.</u>
60	1.99	2.60	3.18	3.72
61	2.08	2.70	3.29	3.84
62	2.17	2.80	3.40	3.96
63	2.25	2.90	3.52	4.07
64	2.34	3.00	3.63	4.19
65	2.43	3.10	3.74	4.31
66	2.52	3.20	3.85	4.43
67	2.61	3.31	3.96	4.55
68	2.70	3.41	4.08	4.67
69	2.79	3.52	4.19	4.79
70	2.88	3.62	4.30	4.91
71	2.99	3.73	4.41	5.03
72	3.08	3.83	4.53	5.15
73	3.17	3.94	4.64	5.26
74	3.27	4.04	4.76	5.38
75	3.37	4.15	4.87	5.50
76	3.47	4.26	4.98	5.62
77	3.57	4.37	5.09	5.74
78	3.67	4.47	5.21	5.86
79	3.77	4.58	5.32	5.98
80	3.87	4.69	5.43	6.10
81	3.98	4.80	5.55	6.22
82	4.09	4.92	5.67	6.34
83	4.19	5.03	5.79	6.47
84	4.30	5.15	5.91	6.59
85	4.41	5.26	6.03	6.71
86	4.52	5.37	6.15	6.83
87	4.63	5.48	6.26	6.95
88	4.73	5.60	6.38	7.06
89	4.84	5.71	6.49	7.18
90	4.95	5.82	6.61	7.30
91	5.06	5.94	6.73	7.42
92	5.17	6.06	6.85	7.54
93	5.29	6.17	6.96	7.60
94	5.40	6.29	7.08	7.78
95	5.51	6.41	7.20	7.90

10 Yr. = 6.1 Rainfall inches
 25 Yr. = 7.0 Rainfall inches
 50 Yr. = 7.8 Rainfall inches
 100 Yr. = 8.5 Rainfall inches

Source: USWB TP40

TABLE: 2-5

RCN / RUNOFF INCHES

PULASKI COUNTY, ARKANSAS
(10, 25, 50, 100 YEAR EVENTS)

SOURCE: THE HODGES FIRM

can be measured either in acres or square miles. Weighted RCN values should be rounded to the nearest whole number.

2.4.4.2 DESIGN STORM DATA

The tabular method is based on 24-hour rainfall amounts for various design recurrence intervals or frequency of occurrence. These rainfall amounts are taken from the U.S. Weather Bureau Technical Paper No. 40 for Little Rock and are as follows: 6.1 inches for the 10-year frequency rainfall; 7.0 inches for the 25-year frequency; 7.8 inches for the 50-year frequency; and 8.5 inches for the 100-year frequency rainfall.

2.4.4.3 DIRECT RUNOFF AMOUNTS FROM DESIGN STORMS (DRO VALUES)

Table 4 is a generalized table of direct runoff amounts for given rainfalls and runoff curve numbers. This table can be used to interpolate runoff amounts (DRO values) from any combination of RCN between 60 and 98 and rainfall amounts between 1 and 12 inches. Table 2-3 provides the direct runoff amounts for RCN values between 60 and 95 based on designed rainfall amounts specific to Little Rock for the 10, 25, 50 and 100-year events. The rainfall amount totals for the Little Rock area that correspond to these frequencies are also shown in Table 2-1.

2.4.5 HYDROGRAPH DISTRIBUTION SELECTIONS

The data in the appendix lists hydrograph distribution values in cubic feet per second per square mile per inch of direct runoff (CSM/inch). These values are listed by hydrograph times from 8 hours to 52 hours in time increments ranging from 15 minutes to 1 hour. There are three pages of data for each given time of concentration (TC) value, the first page being hydrograph times up to 14 1/2 hours, the second up to 29 hours, and the third up to 52 hours. Distribution values are given for travel time (TT) ranging up to 30 hours in time increments ranging from 15 minutes to 2 hours.

Selection of hydrograph distribution for analysis purposes is dependent on the times of concentration for subareas and the travel time, if any, required to reach the design point. Times of concentration are calculated in the same manner as with the Rational Method and will be comprised of two time components - overland flow time and channelized flow time. Refer to Section V for technical aid and discussion useful to time of concentration calculations.

There are two cases that can be encountered in watershed analysis using the tabular method. The first is where two or more subareas reach a confluence at the point under consideration. In this case, no reach routing of subarea hydrographs is required, and the travel time is zero. Time of concentration values are calculated for each subarea to the design point, and in the appendix, data is used to obtain the distribution ordinates for travel time (TT) = 0. The range of hydrograph times selected should always include the values of the distribution.

The second, and more common, analysis case is where several watershed subareas intersect a main stem channel reach at several points above the point under consideration. In this case, each subarea hydrograph distribution must in effect be routed from its confluence with the main stem to the point under consideration. This routing is reflected in the distribution values in the appendix for travel times greater than zero.

Mainstem travel times are calculated in the same manner as described under Section IX for channelized flow. Manning's equation should be used for natural channels to calculate flow velocities based on known cross sections, channel slopes, and weighted roughness coefficients. Mainstems involving pipe systems or improved channels should be analyzed in the same manner as described in Section IX for channelized flow.

Each mainstem segment between the confluences of watershed subareas is a channel reach. The time of flow between points of subarea confluence is the reach time. The sum of all the reach time for the subarea most remote from the design point is that subarea's travel time or TT value. The travel time or TT values for the subareas closer to the design point will reflect only those channel reaches from a subarea confluence to the design point. If the farthest downstream subarea's confluence with the mainstem is at the design point, then this subarea's travel time or TT value is zero. Particular care should be taken in selecting the range of hydrograph times to be used since non-zero travel times have the effect of shifting distribution values. Travel time values should be examined so that a hydrograph time range can be selected that will encompass peak value ranges for all subareas.

Each watershed subarea will have a time of concentration (TC) value and a travel time (TT) value. Calculated TC and TT values may not correspond to the exact values given in the tables in the appendix. Where TC or TT values are not equal to the table values, it is necessary to interpolate between given tabular values to arrive at the ordinate distribution for the subarea. Double interpolation will be

need if neither the TC nor the TT value are equal to distribution table values.

For multiple subareas with non-zero travel times, it is common for reach segments to have local in-flows from tributary areas adjoining the main stem. If such areas are of significance size, they should be treated as additional subareas, and assigned calculated times of concentration and travel times to the design point. Frequently, such local in-flow areas are quite small in nature, and this may result in a time of concentration (TC) less than 0.10 hours (6 minutes). Interpolation for distribution values of TC less than 6 minutes is not advisable. When such small local in-flow areas are encountered along main stem reaches, they may either be ignored or incorporated in the analysis by using the minimum TC value of 0.10 hours.

2.4.6 MANIPULATION AND RECORDING DATA

Figure 2-7 is a tabular method worksheet which provides a convenient system for recording and manipulating calculated results. Column 1 provides space for numbering the major subareas of the study watershed. Columns 2 and 3 should be used to record the calculated TC and TT values for each watershed subarea. The area of each subarea in square miles, should be entered in column 4. Columns 5 and 6 provide for entries of each subarea's weighted RCN value and corresponding direct runoff value (DRO).

Review of the calculated TT values and the appendix tables provides guidance for entry of up to 16 hydrograph times across the top row of the form. The range of hydrograph times should be selected so that peak distribution values for each subarea will fall within the overall time range selected.

Entries under the hydrograph time columns are made for each subarea according to the calculated TC and TT values. Entries may be made either in CSM/inch or CFS. CSM/inch entries are taken or interpolated from the data in the appendix for the calculated TC and TT times. Entries may be made in CFS by multiplying each CSM/inch value by the subarea's value in square miles and direct runoff value in inches.

Subarea hydrograph entries are summed vertically under each time interval of the hydrograph. The totaled figures represent the composite runoff hydrograph at the point under consideration. The peak discharge value for the design point will be the largest number appearing in the composite hydrograph CFS values.

An example problem which illustrates the use of the tabular method is contained in the Appendix.

2.4.7 TABULAR HYDROGRAPH APPLICATIONS

The tabular method product is a composite runoff hydrograph which yields the rate of runoff or peak discharge from a given area or combination of areas. Runoff volume can also be measured since hydrographs are discharge - versus - time plots (cubic feet/unit timex time = cubic feet).

The peak discharge rates are required in design of pipe systems, culverts, ditches, paved channels and other storm water conveyances. The design choice for stormwater conveyances can affect peak discharge rates. When improvements are of significant length and size, channel storage affects may become important. Channel storage is a stormwater management tool which can be used to alter peak discharge rates. Peak flow rates can either be increased or decreased, depending on the design velocities used for various components of a given drainage system. Drainage analysis should always take future drainage facilities into account and, where possible, should use design choices for proposed facilities to minimize increases in peak runoff.

The tabular hydrograph method can be used to evaluate different stormwater system designs and resultant storm peak flow impacts of alternate designs. The ability to measure the impact of design and planning decisions is an important feature of the tabular method. Peak flow values generated by use in the tabular method can be calibrated with established peak flow values for particular streams or watersheds. Calibration is usually accomplished by adjustments in land use assumptions, times of concentrations, and/or travel times so as to produce reasonably close agreement to known flow values of the same frequency of occurrence. Changes in peak flow values from the calibrated results can then be measured for a variety of stormwater management options and controls. Management and design assessments from a calibrated base will generally provide more reliable and acceptable than those from an uncalibrated base.

Stormwater retention is the slowing up of runoff and can take several forms other than velocity manipulation in major conveyances. The tabular method can also be used to evaluate retention measures. There are several approaches to retention, mainly:

1. Adjustment in the amount of rainfall which runs off by changing land use.

2. Adjustment of hydrograph peak discharge values by modification of the overland flow time component.
3. Adjustment of peak flow values by adjustments in the channelized flow time component.
4. Structural retention.

Adjustments in land use can take many forms, including density changes, changes in surface treatments, preservation of natural areas, or changes in basic land use types. Overland flow time adjustments can be affected by altering the flow lengths, roughness coefficients and/or surface slopes in those areas where overland sheet flow affects the design time of concentration. Channelized flow time changes can be made by altering size of facilities, roughness coefficients, hydraulic radius, and/or lengths. Alteration in flow lengths to affect time changes is also sometimes called flow routing. Examples of structural retention measures include rooftop and parking lot ponding, terrace landscaping, routing of rooftop and gutter flows, and use of inlet ponding at culvert structures, i.e., moving from an open channel flow situation to a pipe flow situation.

Tabular method analysis is also useful in modeling watershed subarea interactions. The composite tabular hydrograph for a watershed reflect the discharge - versus - time performance of each of its subareas. Review of each subarea's hydrograph sometimes can be used to identify shifts in the times at which subarea peak discharges can be made to occur so as to lower the composite peak discharge. Shifting of subarea peak discharge times and amounts can be achieved by use of conveyance storage, routing, retention measures, or detention facilities.

Detention facilities are designed for the temporary storage of a significant volume of storm runoff. Hydrograph analysis is required for design of detention facilities in most cases. The SCS tabular method is a soundly-based and convenient means of developing inflow hydrographs for design of detention facilities.

Detention ponds are designed in four steps - determination of the inflow hydrograph, sizing of the required storage, selection of the outlet structure, and routing of the in flow through the pond. Detention ponds are usually designed for a single rainfall event, 10-year, 25-year, 50-year, etc. Since the storage volume and the structure are designed for particular events (in flows), there may be little or no peak flow reduction involved for lesser events. Moreover, since it is impossible to design for the maximum event, emergency overflow provisions must always be provided.

Although detention ponds are usually designed for specific event frequencies, multiple-frequency designs are also possible. Multiple levels of frequency protection or peak flow limitation can be achieved by designing ponds with multiple outlet structures. Multiple storage cells with independent outlet structures are also a way in which detention ponds can be designed for multiple rainfall frequencies.

Detention ponds are a straightforward and simple approach to limiting stormwater peak flows. Detention ponds also usually involve greater capital and maintenance expense than other stormwater and runoff management options. Detention ponds should, therefore, be viewed as a second line of problem solution in the event the most costly options do not produce desired results. It should also be noted that detention ponds, when used in conjunction with other management options, will often be less expensive than as a sole solution.

Additional information and design materials for detention ponds are provided in Section V of this manual.

2.5 HEC I/HEC II COMPUTER METHODS

Computer analysis with the HEC I and HEC II programs shall be the only acceptable method of analysis for problems involving streams that have been mapped by the Federal Emergency Management Agency and that fall under the City or County jurisdiction by virtue of the Floodplain Hazard Prevention Ordinance.

The HEC I computer program is used to developed watershed hydrology from land use data, topographic information, rainfall events, and rainfall distribution patterns. The HEC II computer program uses the HEC I results as input along with various hydraulic data to produce flood profiles and other data for specific streams and stream segments.

Use of these methods requires substantial technical training, access to the source programs, and use of a relatively large computer. Construction and use of these programs is beyond the scope of this manual, but is available at nominal cost from the Hydrological Engineering Center, U.S. Corps of Engineers, U.S. Department of Army, 609 2nd Street, Davis, California 95616 or from the University of Texas at Austin. Requestors should ask for the HEC I and/or HEC II user manuals and should be prepaid by check or money order made payable to "FAO-USAED," at the Hydrological Engineering Center in Davis, California.

SECTION III - FLOW IN STORM DRAINS AND DRAINAGE
APPURTENANCES

- 3.1 General
- 3.2 Storm Sewer Design Requirements
- 3.3 Requirements Relative to Improvements
 - 3.3.1 Bridges and Culverts
 - 3.3.2 Closed Storm Sewer
 - 3.3.3 Maximum Grades
 - 3.3.4 Open Paved Channels
 - 3.3.5 Open Ditches (Earth Channels)
- 3.4 Full or Part Full Flow in Storm Drains
 - 3.4.1 General
 - 3.4.2 Pipe Flow Charts
 - 3.4.3 Roughness Coefficients
 - 3.4.4 Manhole Location
 - 3.4.5 Pipe Connections
 - 3.4.6 Minor Head Losses at Structures
- 3.5 Utilities

SECTION III - FLOW IN STORM DRAINS AND DRAINAGE
APPURTENANCES

3.1 GENERAL

A general description of storm drainage systems and quantities of storm runoff is in Sections II and III of this manual. It is the purpose of this section to consider the significance of the hydraulic elements of storm drains and their appurtenances to a storm drain system.

Hydraulically, storm drainage systems are conduits (open or closed) in which unsteady and nonuniform free flow exists. Storm drains accordingly are designed for open-channel flow to satisfy as well as possible the requirements for unsteady and nonuniform flow. Steady flow conditions may or may not be uniform.

3.2 STORM SEWER DESIGN REQUIREMENTS

In preparation of storm sewer design, the following is a list of minimum requirements:

1. A plan of the drainage area at a scale of 1" = 200' with 10-foot contour intervals using USGS datum for areas less than 100 acres or a plan of the drainage area at a scale of 1" = 500' with 10-foot contour intervals for larger areas. This plan shall include all proposed street, drainage and grading improvements with flow quantities and direction at all critical points. All areas and subareas for drainage calculations shall be clearly distinguished.
2. Complete hydraulic data showing all calculations, including a copy of all nomographs and graphs used for your calculations shall be submitted.
3. A plan and profile of all proposed improvements at a scale of 1" = 50' horizontal and 1" = 5' vertical shall be submitted. This plan shall include the following: locations, sizes, flow line elevations and grades of pipes, channels, boxes, manholes and other structures drawn on standard plan-profile sheets; existing and proposed ground line profiles; a list of the kind and quantities of materials; typical sections of all boxes and channels; and location of property lines, street paving, sanitary sewers and other utilities.
4. A field study of the downstream capacity is highly suggested of all drainage facilities and the effect of additional flow from the area to be improved shall be submitted. If the effect is to endanger property or

life, the problem must be resolved before the plan will be given approval.

5. Stormwater flow quantities in the street shall be shown at all street intersections and all inlet openings and locations where flow is removed from the streets. This shall include the hydraulic calculations for all inlet openings and street capacities. The street flow shall be limited according to Section VI, Pavement Drainage Design.
6. Any additional information deemed necessary by the City Engineer for an adequate consideration of the storm drainage effect on the City of Little Rock and surrounding areas must be submitted.

3.3 REQUIREMENTS RELATIVE TO IMPROVEMENTS

3.3.1 BRIDGES AND CULVERTS

Bridges or culverts shall be provided where continuous streets or alleys cross water courses and shall be designed to accommodate a 100-year flood on floodways or floodplains, a 50-year frequency rain on arterial roads and streets, 25-year frequency rain for minor arterials and collectors, and a 10-year frequency rain for all other streets. The structure shall be designed in accordance with current Arkansas Highway and Transportation Department specifications for materials and to carry H-20 loadings in any case.

Where same structure is to be constructed in a location other than existing or proposed street right-of-way, H-10 loadings may be used.

3.3.2 CLOSED STORM SEWER **SEE REVISED**

~~Closed storm sewers for all conditions other than required in Section 3.3.1 above shall be designed to accommodate a 10-year frequency rain, based on the drainage area involved. Same shall either be R.C. box for H-20 loadings and street right-of-way or H-10 loadings elsewhere, or R.C. pipe ASTM Class III when sufficient cover is provided or ASTM Class IV when less than one-foot under paving or less than two feet of cover.~~

Under special conditions, the use of corrugated metal pipe may be permitted by special authority of the City Engineer.

3.3.3 MINIMUM GRADES

Storm drains should operate with velocities of flow sufficient to prevent excessive deposition of solid

REVISIONS TO SECTION 3 OF THE STORM WATER MANAGEMENT AND DRAINAGE MANUAL

3.3.2. CLOSED STORM SEWER

Replace all existing language with the following:

Closed storm sewers for all conditions other than required in Section 3.3.1. Above shall be designed to accommodate at a minimum frequency rain, according to the Master Street Plan standards based on the drainage area involved. Refer to Section 13 of the City of Little Rock Standard Specifications for allowable pipe materials, applications, and installation.

Closed storm sewers for subdivision and public project developments that are located along or near side property lines shall be extended to the back property line or to receiving stream. If significant terrain relief exists, a variance may be granted. Request for variance must be made at the time the design plans are approved by the City.

Where a swale is used, a 4 foot wide by 4 inch thick concrete invert is required if the flow exceeds 10 cubic feet per second. (Swales are permitted above 72" diameter pipes until swale capacity reaches 72" capacity.)

Headwalls are permitted only on storm sewer 48 inch diameter or smaller unless easement or terrain constraints exist. For storm sewer larger than 48 inch diameter, slope treatment shall be required. Allowable materials for headwalls and slope treatments are plain concrete; colored, textured or patterned concrete; exposed aggregate; decorative rock; bomonite; split face block; or segmental wall sections.

3.3.4. OPEN PAVED CHANNELS

Open paved channels are only permitted when flows exceed capacity of two 72 inch diameter pipes.

Slope sided channel is preferred if right-of-way or easement allows. Grass or sod may be used on slopes flatter than or equal to 3:1 with a paved bottom designed to accommodate a two-year storm event.

Where right-of-way or easement constraints do not allow for a 3:1 slope, a steeper paved slope or vertical wall channel is permitted. Concrete is required to be specially treated materials such as colored concrete to provide a darker appearance; exposed aggregate concrete; textured concrete; split face block; decorative segmental wall sections; or bomonite.

If the channel is deeper than 4 feet and/or slope is steeper than or equal to 2:1, the channel is required to be terraced every 4 foot (maximum) in height (mid height is recommended for less than 8 feet) to provide a visible break and a means of escape for children. A 2 foot minimum width paved terrace is required to have a minimum cross slope of one inch per foot for proper drainage. A 6 foot high fence is also required and may be galvanized chain link fence with 36 inch high evergreen plantings every 3 feet, vinyl coated chain link fence, or wood fence if the neighborhood association provides maintenance.

material; otherwise, objectionable clogging may result. The controlling velocity is near the bottom of conduits and considerably less than the mean velocity. Storm drains shall be designed to have a minimum velocity flowing full of 2.5 fps. Table 3-1 indicates the grades for both concrete pipe (N = 0.013) and for corrugated metal pipe (N = 0.024) to produce a velocity of 2.5 fps, which is considered to be the lower limit of scouring velocity. Grades for closed storm sewers and open paved channels shall be designed so that the velocity shall not be less than 2.5 fps nor exceed 12 fps. All other structures such as junction boxes or inlets shall be in accordance with City standard drawings. The minimum slope for standard construction procedures shall be 0.40 percent when possible. Any variance must be approved by the City Engineer.

Table 3-1

Minimum Slope Required
to Produce Scouring Velocity

Pipe Size (Inches)	Concrete Pipe Slope ft./ft.	Corrugated Metal Pipe ft./ft.
18	0.0018	0.0060
21	0.0015	0.0049
24	0.0013	0.0041
27	0.0011	0.0035
30	0.0009	0.0031
36	0.0007	0.0024
42	0.0006	0.0020
48	0.0005	0.0016
54	0.0004	0.0014
60	0.0004	0.0012
66	0.0004	0.0011
72	0.0003	0.0010
78	0.0003	0.0009
84	0.0003	0.0008
96	0.0002	0.0007

Closed storm sewers extending to furthestest downstream point of development shall give consideration to velocities and discharge energy dissipaters to prevent erosion and scouring along downstream properties.

~~3.3.4 OPEN PAVED CHANNELS **SEE REVISED**~~

~~Open paved channels may be used instead of closed storm sewers when the flow exceeds 100 CFS for a 100-year storm frequency. Open paved storm drainage channels shall be designed to accommodate a 100-year frequency rain, based~~

SEE REVISED

~~the drainage area involved. Such channels may be of different shapes according to existing conditions; however, a channel with a flat bottom with a "V" notch for low minimum flows and 4:1 to 5:1 side slopes is the most desirable type and shall be used whenever possible. The channel shall be of concrete with a minimum four inch thickness. Six-inch minimum thickness required where maintenance by machinery. Thickness of concrete and amount of reinforcing steel shall depend upon conditions at site and size of channel. A 6"-8" drag lip should be provided as appropriate in each design.~~

3.3.5 OPEN DITCHES (EARTH CHANNELS)

Open earth ditches may be used instead of closed storm sewers or open paved ditches only in extremely large areas where flow exceeds 250 CFS for a 10-year storm frequency and in very small areas where flow is less than 10 CFS for a 10-year storm frequency.

Ditches shall have a gradient to keep the velocity within 1.5 to 5.0 feet per second depending on existing soil conditions. Ditches may be seeded, sod mulched, or sodded where design velocities are less than 3 fps. Sod shall be required for velocities greater than 3 fps. Side slopes shall have a minimum slope ratio of 3:1. See Table 3-2 for permissible velocities for swales, open channels, and ditches with uniform stands of various well maintained grass covers. Designer's attention is directed to the fact that the Subdivision Ordinance prohibits encroachment of buildings and improvements on natural or designated drainage channels, or the channel's floodplains. Such floodplains are areas of land adjacent to an open paved channel or open sodded ditch (not in closed storm sewers) that may flood during a 100-year rain. Such floodplains shall be indicated on drainage improvement plans and individual plot plans.

3.4 FULL OR PART FULL FLOW IN STORM DRAINS

3.4.1 GENERAL

The size of closed storm sewers, open channels, culverts and bridges shall be designed so that their capacity will not be less than the volume computed by using the Manning Formula. All storm drains shall be designed by the application of the continuity equation and Manning's Formula either through the appropriate charts and nomographs, or by direct solutions of the equations as follow:

TABLE 3-2

PERMISSIBLE VELOCITIES FOR CHANNELS LINED WITH GRASS*

Cover	Slope range, %	Permissible velocity, fps	
		Erosion-resistant soils	Easily eroded soils
Bermuda grass	0-5	8	6
	5-10	7	5
	>10	6	4
Buffalo grass, Kentucky bluegrass, smooth brome, blue grama	0-5	7	5
	5-10	6	4
	>10	5	3
Grass mixture	0-5	5	4
	5-10	4	3
Do not use on slopes steeper than 10%			
Lespedeza sericea, weeping love grass, ischaemum (yellow blue- stem), alfalfa, crabgrass	0-5	3.5	2.5
	Do not use on slopes steeper than 5%: except for side slopes in a combination channel		
Annuals—used on mild slopes or as temporary protection until per- manent covers are established, common lespedeza, Sudan grass	0-5	3.5	2.5
	Use on slopes steeper than 5% is not recommended		

REMARKS. The values apply to average, uniform stands of each type of cover. Use velocities exceeding 5 fps only where good covers and proper maintenance can be obtained.

SOURCE: AHTD

Q = AV and

$$Q = \frac{1.49}{n} AR^{2/3} S_f^{1/2}$$

Q = Capacity = discharge in cubic feet per second

A = Cross-sectional area in conduit or channel in square feet

R = Hydraulic radius = $A \div$ wetted perimeter

S_f = Friction slope in pipe (feet per foot)

n = Coefficient of roughness of pipe

There are several general rules to be observed when designing storm sewer runs. When followed, they will tend to alleviate or eliminate the common mistakes made in storm sewer design. These rules are as follows:

1. Select pipe size and slope so that the velocity of flow will increase progressively, or at least will not appreciably decrease at inlets, bends or other changes in geometry or configuration. A 15" minimum pipe diameter is the minimum acceptable pipe diameter for maintenance purposes. Where used, corrugated metal pipe sizes shall be hydraulically equivalent to the required pipe size.
2. Do not discharge the contents of a larger pipe into a smaller one, even though the capacity of the smaller pipe may be greater due to steeper slope.
3. At changes in pipe sizes, match the soffits of the two pipes at the same level rather than matching the flow lines.
4. Conduits are to be checked at the time of their design with reference to critical slope. If the slope of the line is greater than critical slope, the unit will likely be operating under entrance control instead of the originally assumed normal flow. Conduit slopes should be kept below critical slope if at all possible. This also removes the possibility of a hydraulic jump within the line.

3.4.2 PIPE FLOW CHARTS

Pipe flow charts are nomographs for determining flow properties in circular pipe, elliptical pipe and pipe-arches. Figures 3-1 through 3-9 are nomographs based upon a value of "n" of 0.012 for concrete and 0.024 for corrugated metal. The charts are self-explanatory, and

their use is demonstrated by the example in Figure 3-1.

For values of "n" other than 0.012, the value of Q should be modified by using the formula below:

$$Q_c = \frac{Q_n (0.012)}{n_c}$$

Q_c = Flow based upon n_c

n_c = Value of "n" other than 0.012

Q_n = Flow from nomograph based on $n = 0.012$

This formula is used in two ways. If $n_c = 0.015$ and Q_c is unknown, use the known properties to find Q_n from the nomograph, and then use the formula to convert Q_n to the required Q_c . If Q_c is one of the known properties, you must use the formula to convert Q_c (based on n_c) to Q_n (based on $n = 0.012$) first, and then use Q_n and the other known properties to find the unknown value on the nomograph.

Example 1:

Given: Slope = 0.005, depth of flow (d) = 1.8', diameter D = 36", n = 0.018

Find: Discharge (Q)

First determine $d/D = 1.8'/3.0' = 0.6$. Then enter Figure 3-1 to read $Q_n = 34$ cfs. Using the formula $Q_c = 34 (0.012/0.018) = 22.7$ cfs (answer).

Example 2:

Given: Slope = 0.005; diameter D = 36", Q = 22.7 cfs, n = 0.018

Find: Velocity of flow (fps)

First convert Q_c to Q_n so that nomograph can be used. Using the formula $Q_n = 22.7 (0.018)/(0.012) = 34$ cfs, enter Figure 3.1 to determine $d/d = 0.6$. Now enter Figure 3-3 to determine $V = 7.5$ fps (answer).

3.4.3 ROUGHNESS COEFFICIENTS

Roughness coefficients for storm drains are as follows in Table 3-3.

Table 3-3

Roughness Coefficients "n" for Storm Drains

<u>Materials of Construction</u>	<u>Design Coefficient</u>	<u>Range of Manning Coefficient</u>
Concrete Pipe	0.012	0.011-0.015
Corrugated Metal Pipe		
. Plain or Coated	0.024	0.022-0.026
. Paved Invert	0.020	0.018-0.022

Concrete pipe shall have a design coefficient of 0.012 and have a range of manning coefficient of 0.011-0.015. Corrugated metal pipe - plain or coated shall have a design coefficient of 0.024 and a range of manning coefficient of 0.022-0.026. Corrugated metal pipe - paved invert shall have a coefficient of 0.020 and a range of manning coefficient of 0.018-0.022.

3.4.4 MANHOLE LOCATION

Manhole shall be located at intervals not to exceed 500 feet for pipes 30 inches in diameter or smaller. Manholes shall preferably be located at street intersections, conduit junctions, changes of grade, changes of horizontal alignment and all changes of pipe sizes. Manholes for pipe greater than 30 inches in diameter shall be located at points where design indicates entrance into the conduit is desirable; however, in no case shall the distance between openings or entrances be greater than 1,200 feet.

3.4.5 PIPE CONNECTIONS

Prefabricated wye and tee connections are available up to and including 24" x 24". Connections larger than 24" will be made by field connections. This recommendation is based primarily on the fact that field connections are more easily fitted to a given alignment than a precast connection. Regardless of the amount of care exercised by the contractor in laying the pipe, gain and footage invariably throws precast connections slightly out of alignment. This area increases in magnitude as the size of pipe increases.

3.4.6 MINOR HEAD LOSSES AT STRUCTURES

The following total energy head losses at structures shall be determined for inlets, manholes, wye branches or bends and the design of closed conduit. See figures 3-10 and 3-11

for details of each case. Minimum head loss used at any structure shall be 0.10 foot, unless otherwise approved.

The basic equation for most cases, where there is both upstream and downstream velocity, takes the form as set forth below with the various conditions of the coefficient of K_j shown in Tables 3-4, 3-5 and 3-6.

$$H = K_j \frac{(v_2^2 - v_1^2)}{2g}$$

h_j = junction or structure head loss and feet.

v_1 = velocity in upstream pipe and feet per second.

v_2 = Velocity in downstream pipe and feet per second.

K_j = Junction or structure coefficient of loss.

In the case where the initial velocity is negligible feet, the equation for head loss becomes:

$$h_j = h_j \frac{V_2^2}{2G}$$

Short radius bends may be used on 24 inch or larger pipes where flow must undergo a direction change at a junction or bend. Reductions in head loss at manholes may be realized in this way. A manhole shall always be located at the end of such short radius bends.

The values of the coefficient " K_j " for determining the loss of head due to obstructions in pipe are shown in Table 3-5 and the coefficients are used in the following equation to calculate the head loss at the obstruction:

$$h_j = k_j \frac{(v_2^2)}{2g}$$

The values of the coefficient " K_j " for determining the loss of head due to sudden enlargements and sudden contractions in pipes are shown in Table 3-6 and the coefficients are used in the following equation to calculate the head loss at the change in Section:

$$h_j = k_j \frac{v^2}{2g} \quad \text{where } v = \text{velocity in smaller pipe.}$$

3.5 UTILITIES

In the design of a storm drainage system, the engineer is frequently confronted with the problem of grade conflict between the proposed storm drain and existing utilities, such as water, gas and sanitary sewer lines.

When conflicts arise between a proposed drainage system and utility system, the owner of the utility system shall be contacted and made aware of the conflict. Any adjustments necessary to the drainage system or the utility can then be determined.

Due to the difficulty and expense to the public with regard to hand cleaning, clearing, and other ditch maintenance, the following ditch requirements are specified to expedite small equipment cleaning and access to drainage easements and ditches:

- . Manholes are not allowed in drainage ditches.
- . Access easements shall be required every 600 feet.
- . Utility crossings (above the channel flowline) shall be limited to one per block.
- . Utilities shall not be located beneath a concrete bottom except at crossings.

See Figure 3-12 for dimensions of utility easements required when drainage facilities are installed within the same easement.

Table 3-4

Junction or Structure
Coefficient of Loss

Case No.	Reference Figure	Desc. of Condition	Coefficient K_j
I		Inlet on Main Line **	0.50
II		Inlet on Main Line with Branch Lateral **	0.25
III		Manhole on Main Line with 45° Branch Lateral	0.50
IV		Manhole on Main Line with 90° Branch Lateral	0.25
V		45° Wye Connection or Cut-in	0.75
VI		Inlet on Manhole at Beginning of Line	1.25
VII		Conduit on Curves for 90°***	
		Curve Radius = Diameter	0.50
		Curve Radius - (2 to 8) Diameter	0.40
		Curve Radius - (8 to 20) Diameter	0.25
VIII		Bends Where Radius is Equal to Diameter	
		90° Bend	0.50
		60° Bend	0.48
		45° Bend	0.35
		22 1/2° Bend	0.20
		Manhole on Line with 60° Lateral	0.35
		Manhole on Line with 22 1/2° Lateral	0.75

NOTES:

** Must be approved by City Engineer.

*** Where bends other than 90° are used, the 90° bend coefficient can be used with the following percentage factor applied:

60° Bend - 85%
45° Bend - 70%
22 1/2° Bend - 40%

Source: City of Waco, Texas, Storm Drainage Design Manual

Table 3-5

Head Loss Coefficients Due to Obstructions

$\frac{A^{**}}{A}$	K_j	A.	K_j
1.05	0.10	3.0	15.0
1.1	0.21	4.0	27.3
1.2	0.50	5.0	42.0
1.4	1.15	6.0	57.0
1.6	2.40	7.0	72.5
1.8	4.00	8.0	88.0
2.0	5.55	9.0	104.0
2.2	7.05	10.0	121.0
2.5	9.70		

** $\frac{A}{A}$ = Ratio of area of pipe to opening at obstruction.

Table 3-6

Head Loss Coefficients Due to Sudden Enlargements and Contractions

$\frac{D_2^{**}}{D_1}$	Sudden Enlargements K_j	Sudden Contractions K_j
1.2	0.10	0.08
1.4	0.23	0.18
1.6	0.35	0.25
1.8	0.44	0.33
2.0	0.52	0.36
2.5	0.65	0.40
3.0	0.72	0.42
4.0	0.80	0.44
5.0	0.84	0.45
10.0	0.89	0.46
	0.91	0.47

** $\frac{D_2}{D_1}$ = Ratio of larger to smaller diameter.

Source: City of Waco, Texas, Storm Drainage Design Manual

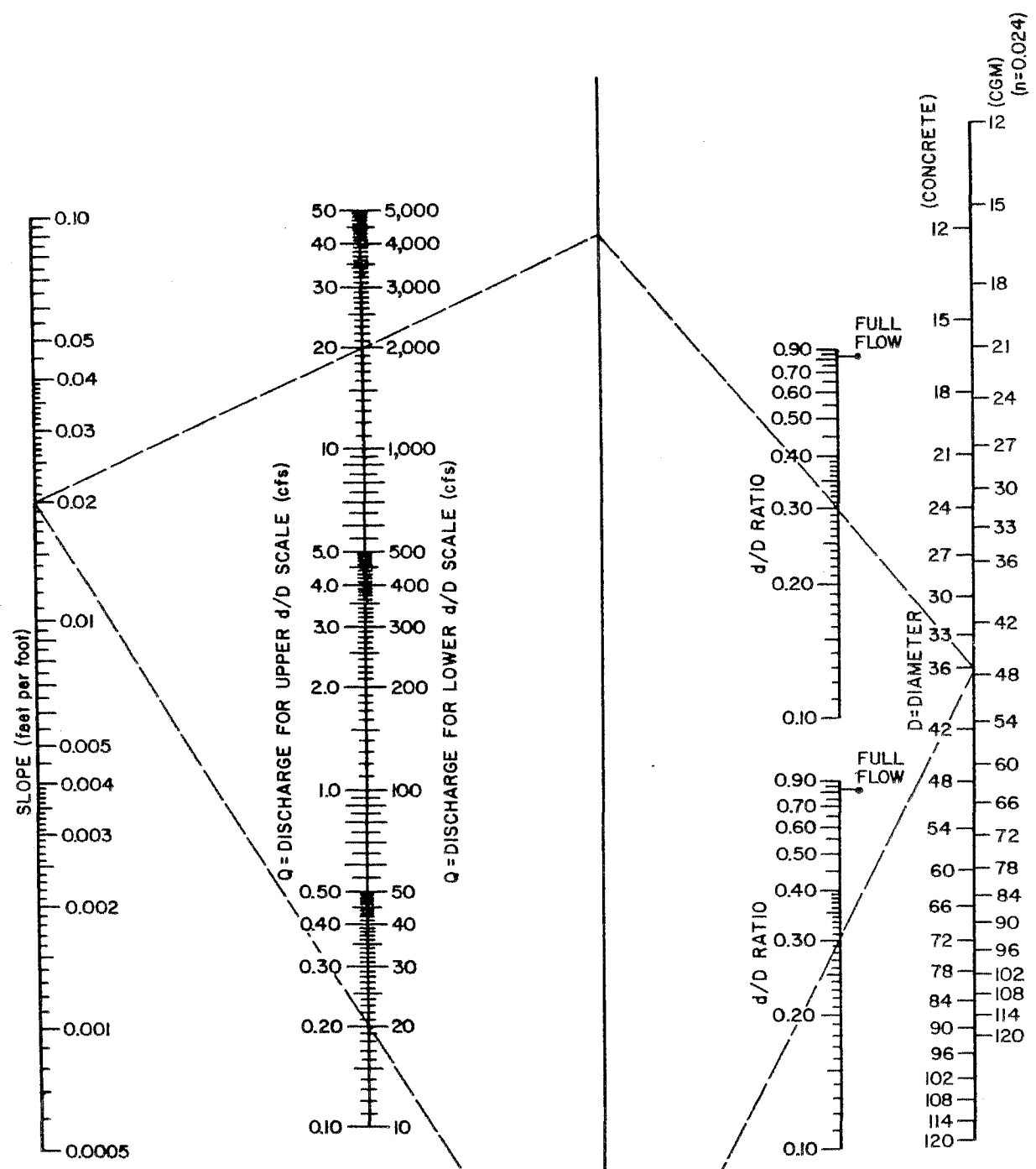

EXAMPLE

GIVEN: S = 0.02 FIND: d/D =
 Q = 20 cfs d =
 D = 36" (CONCRETE)

SOLUTION

d/D = 0.30
 d = 0.30 × 3' = 0.9'

SOURCE: AHTD



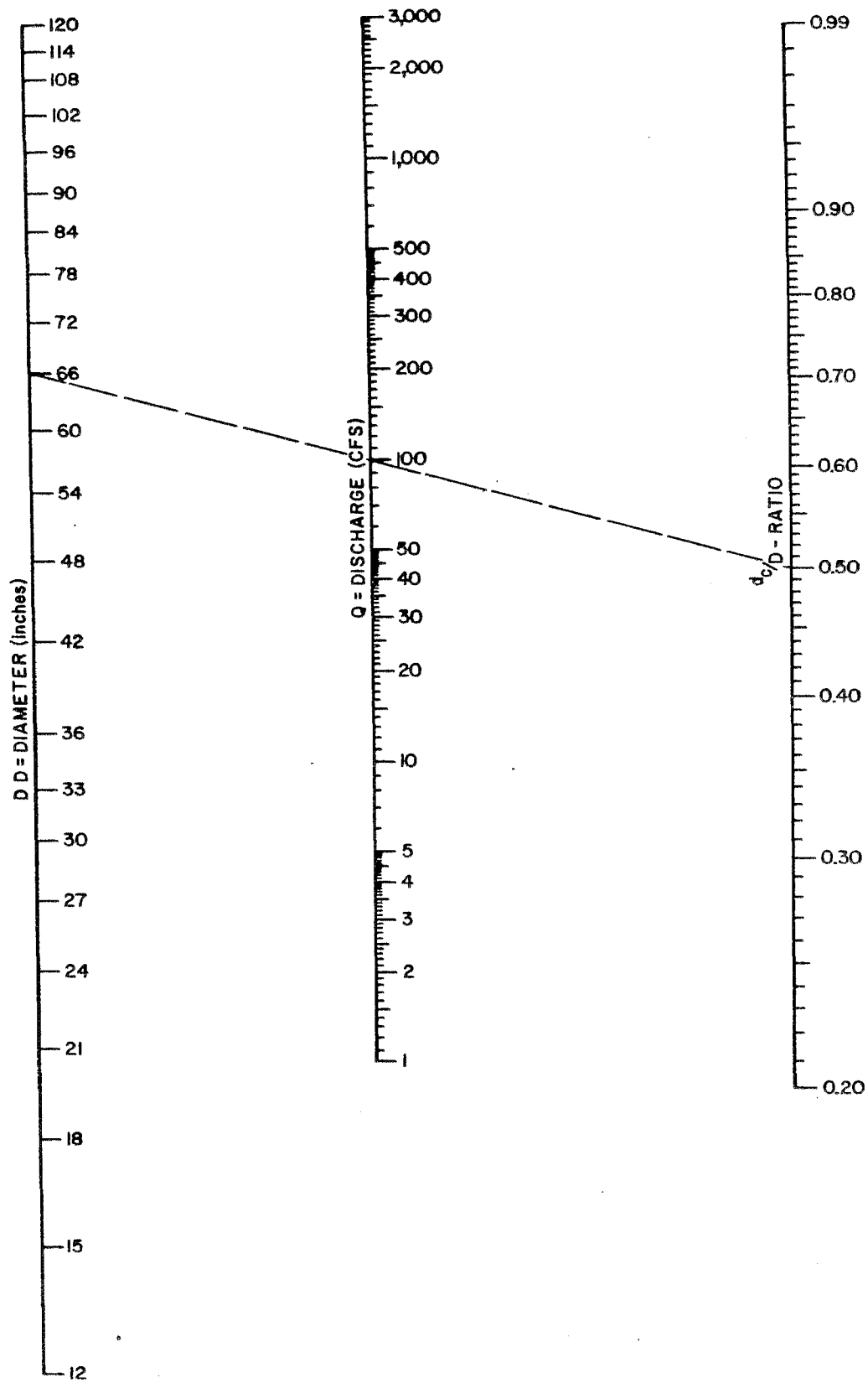

SOURCE: THD

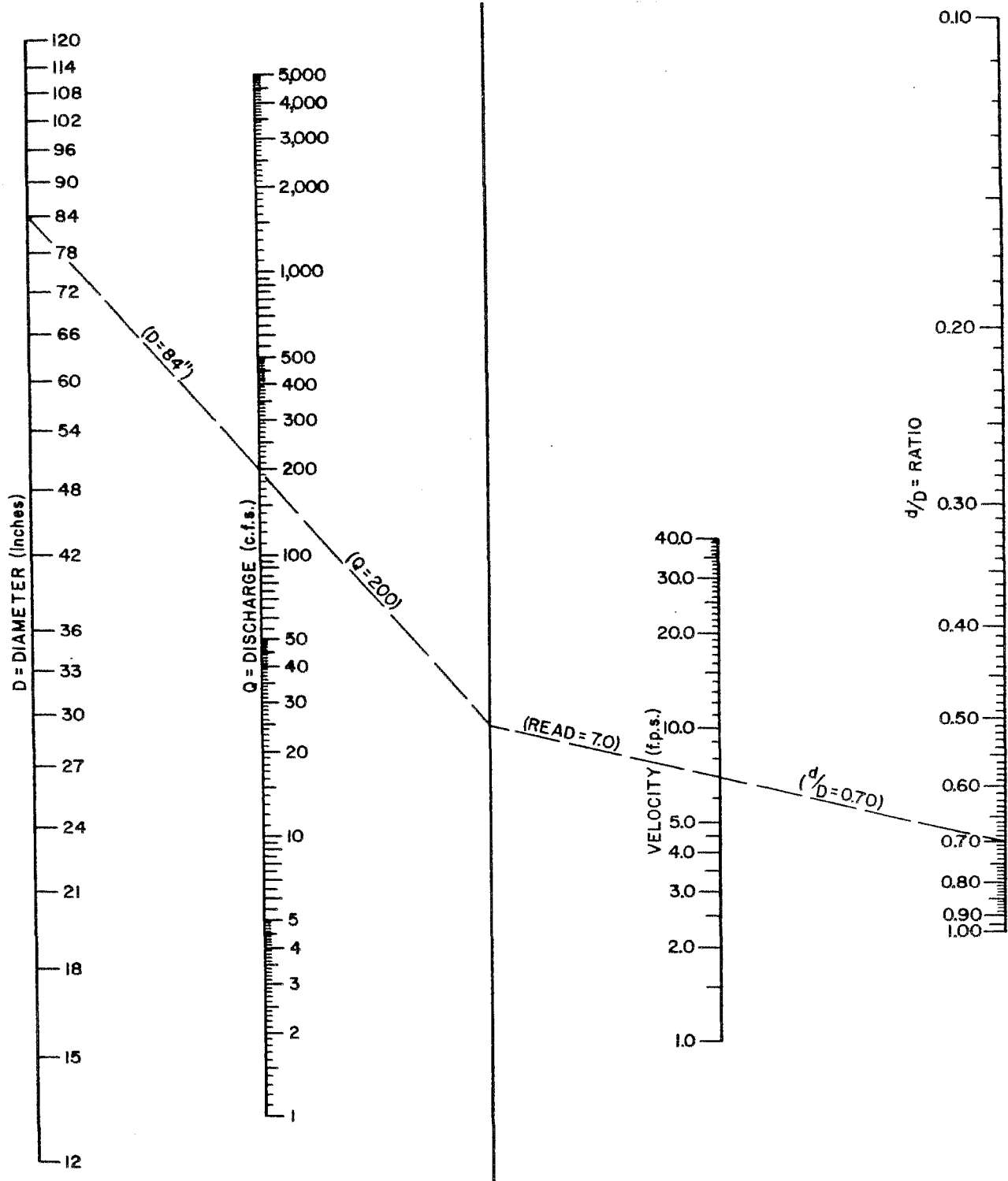

SOURCE: AHTD Fig. 3-3 - 3-9

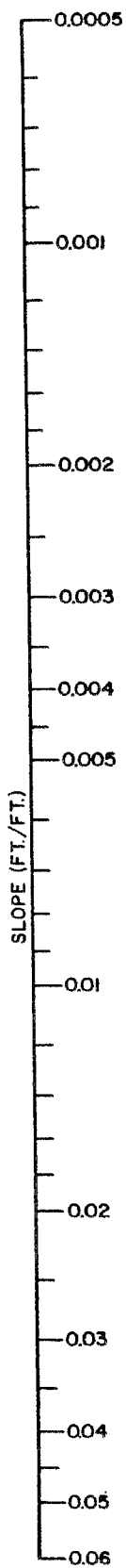

TURNING LINE

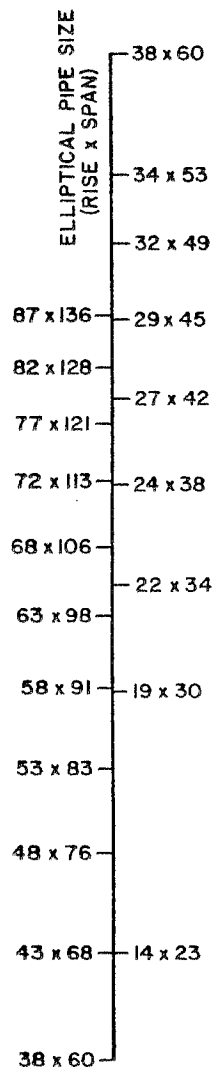
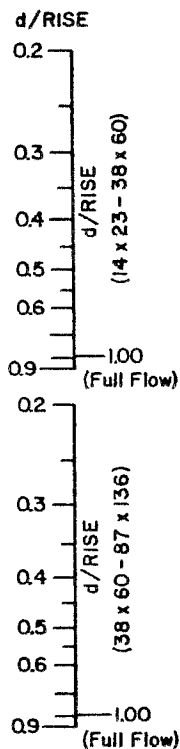

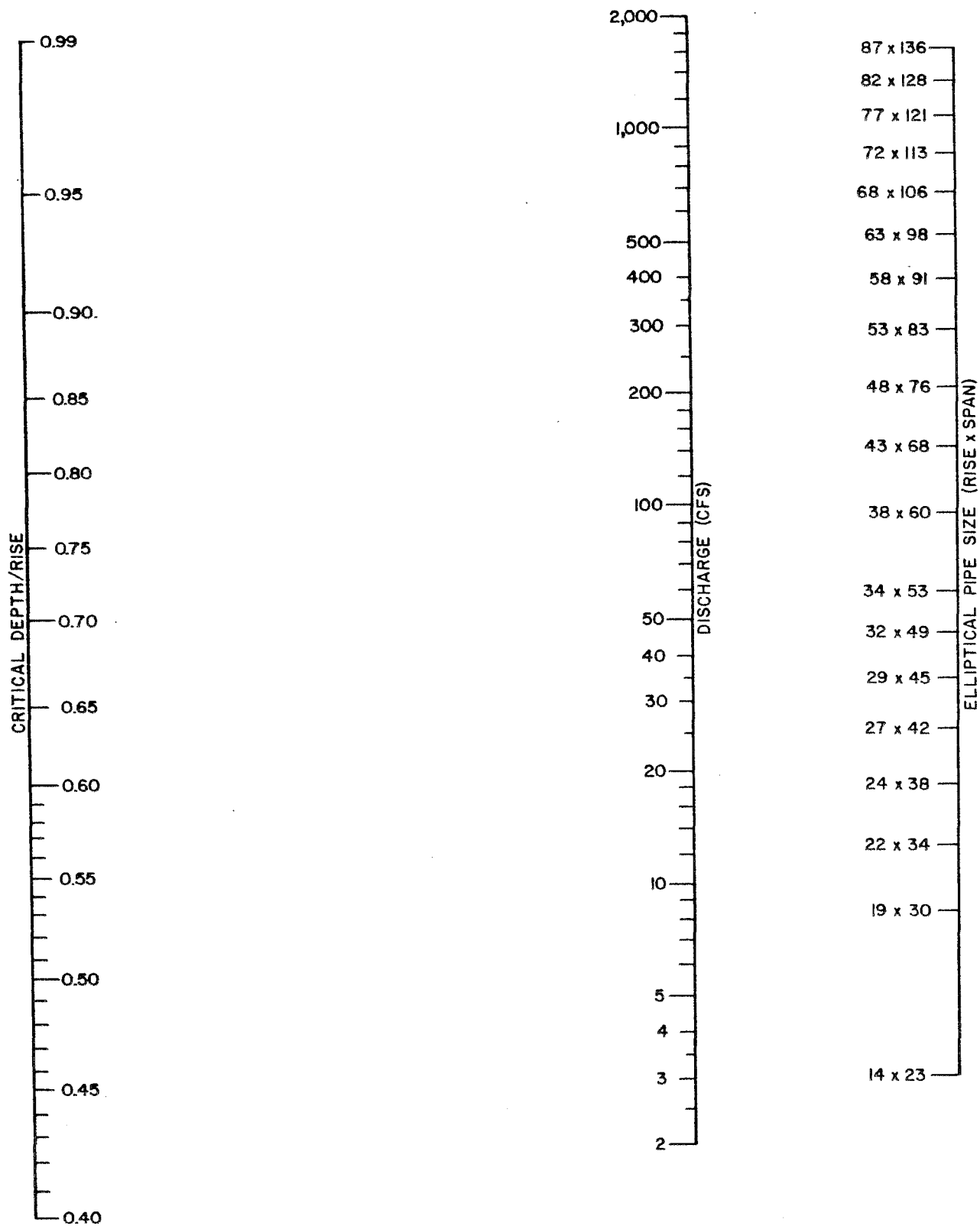

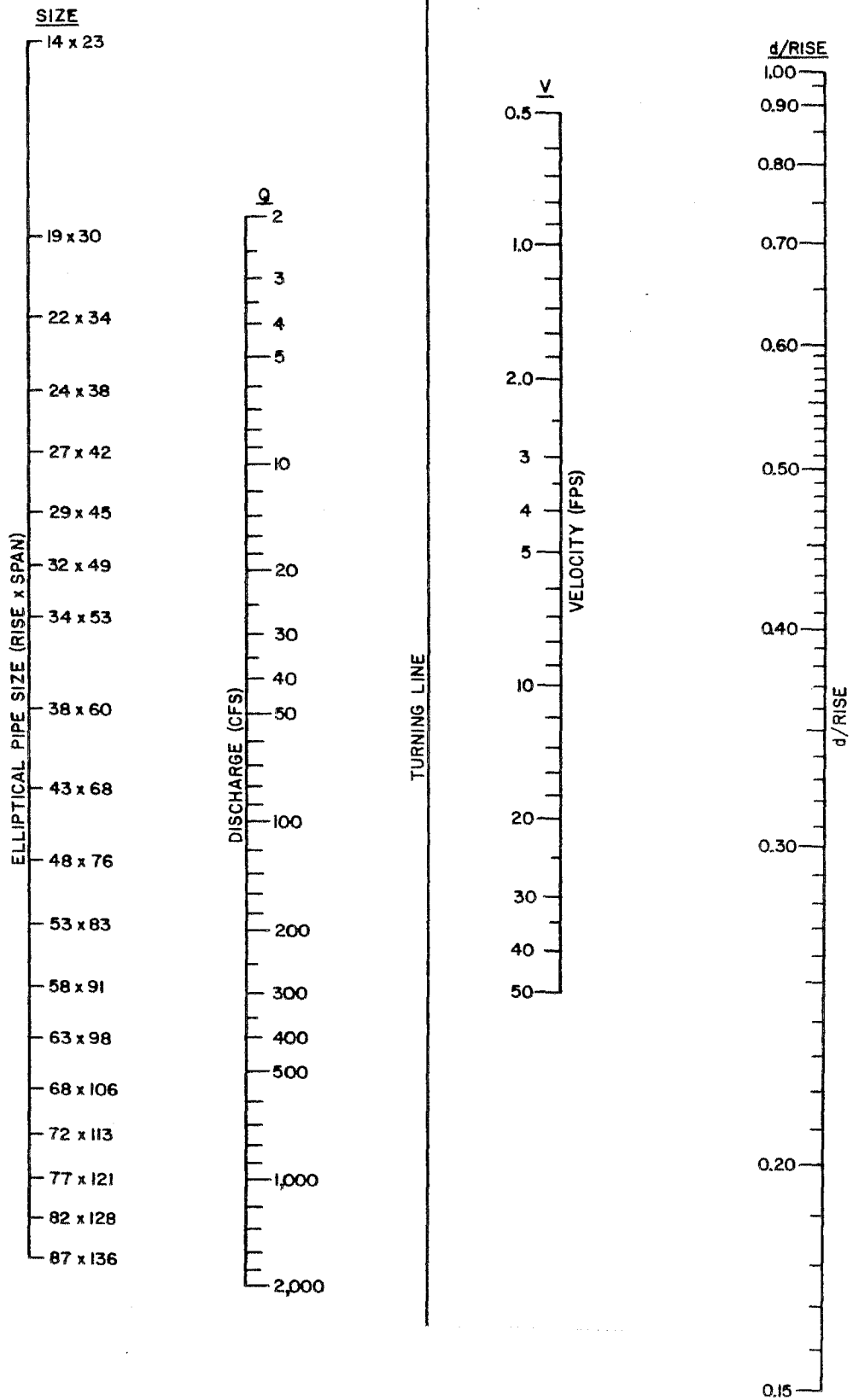

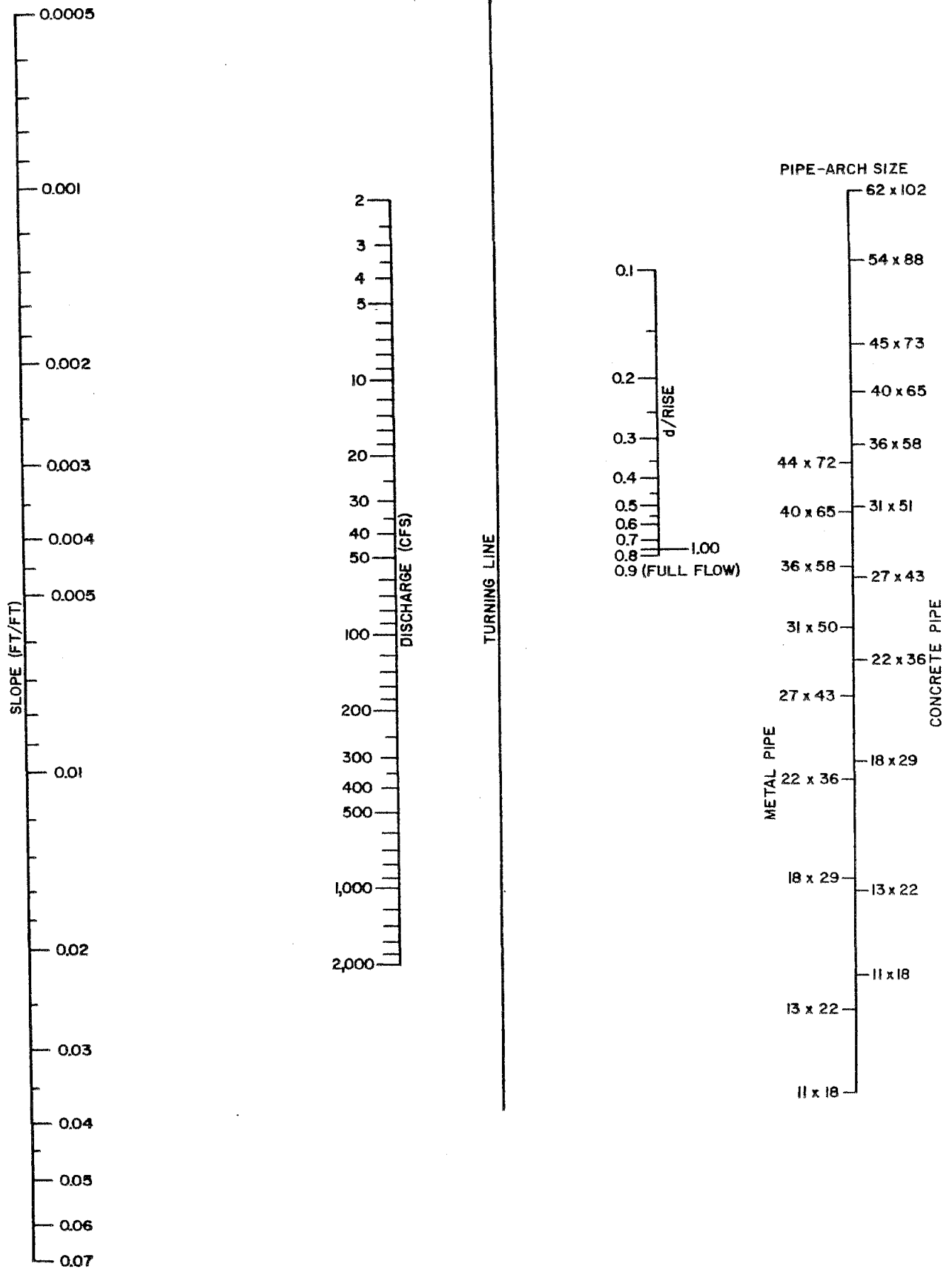

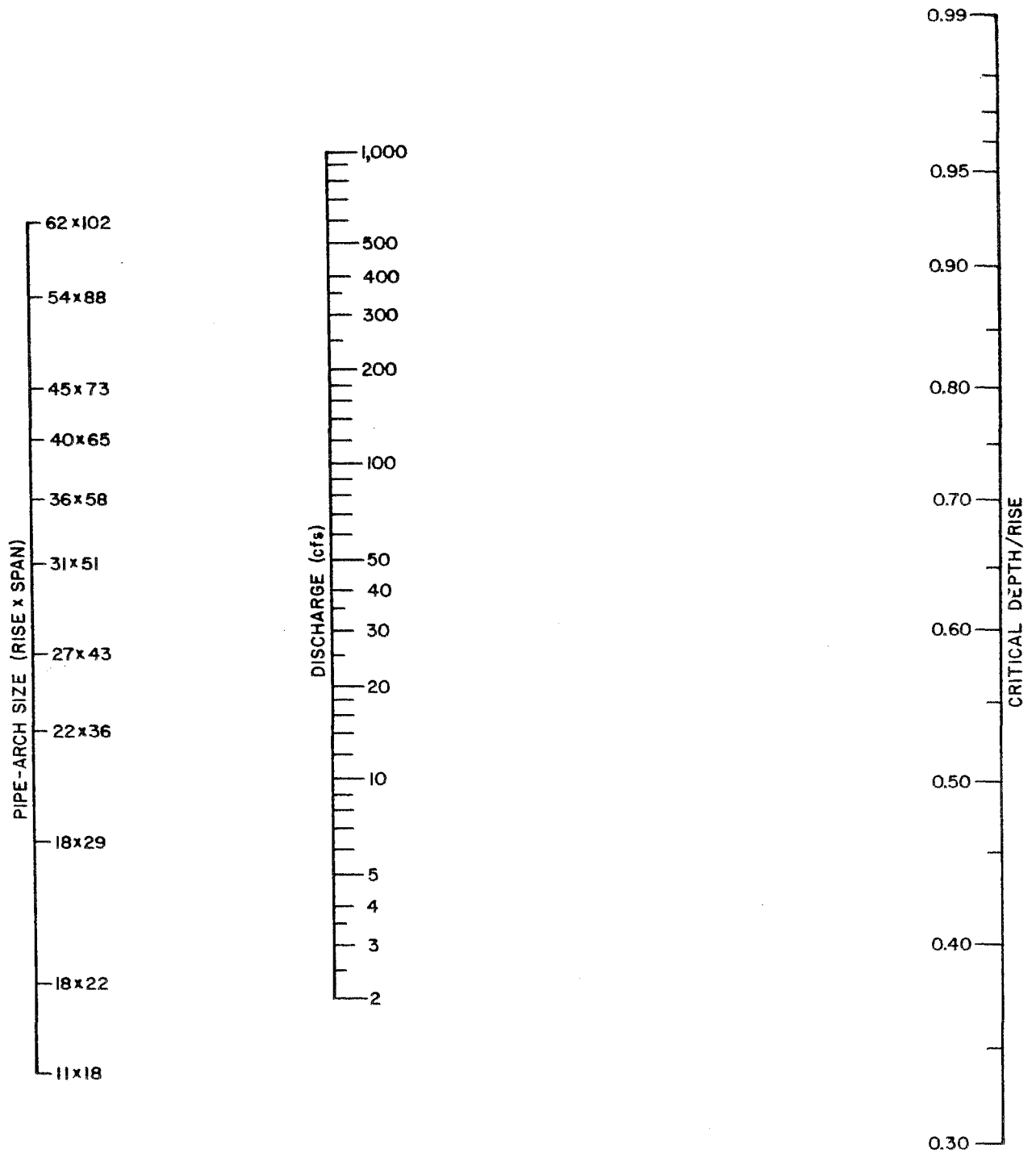

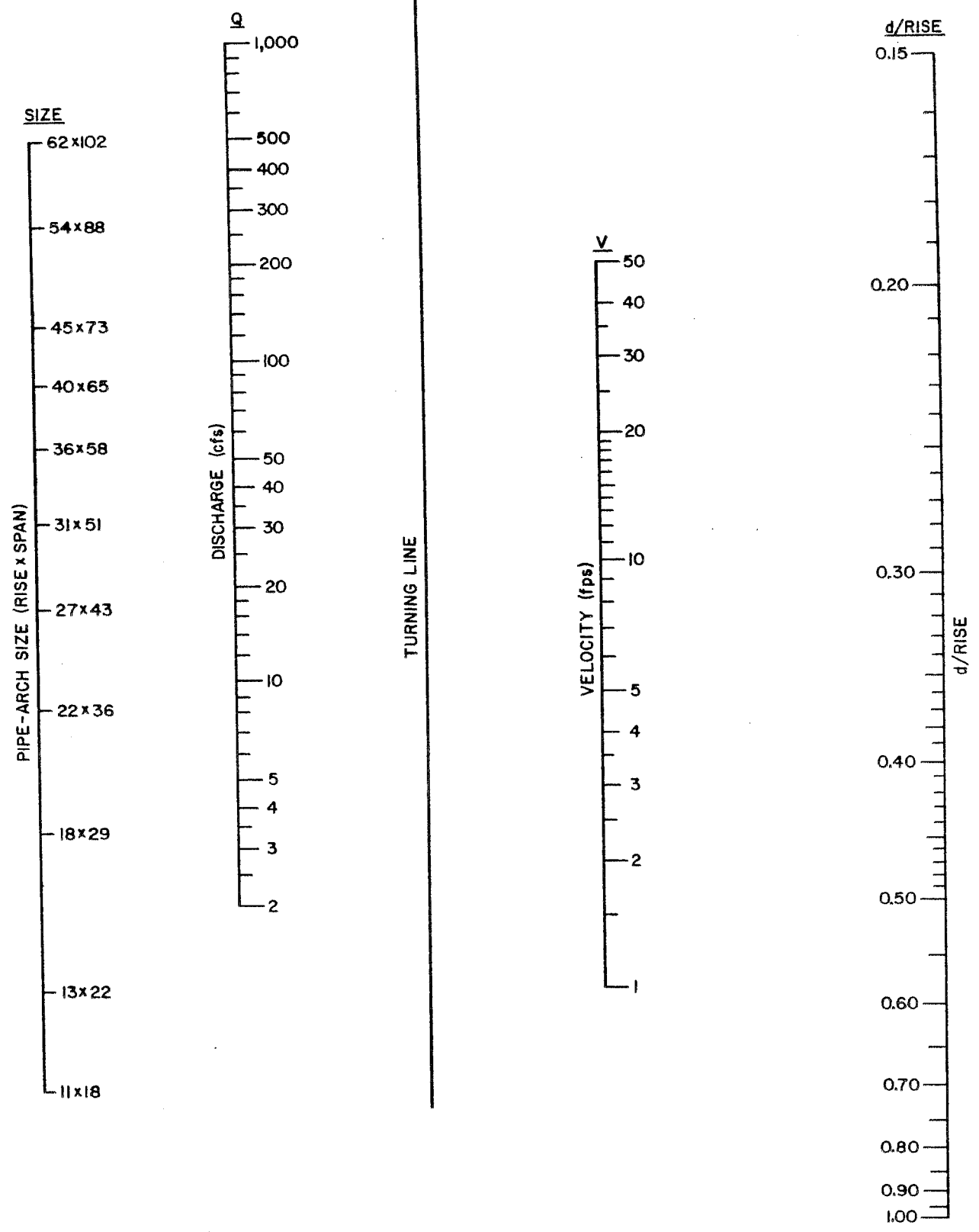

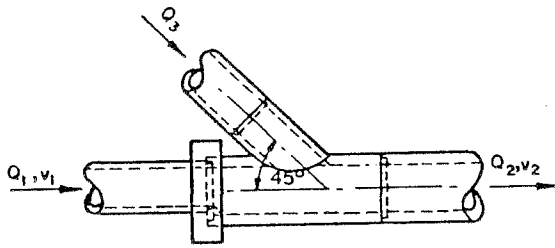

PLAN

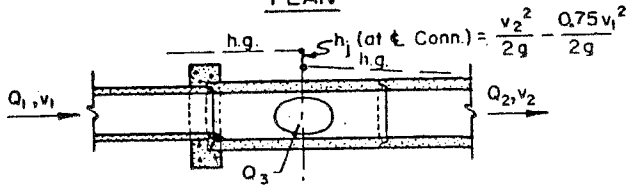

SECTION

CASE V
45° WYE CONNECTION
OR CUT IN

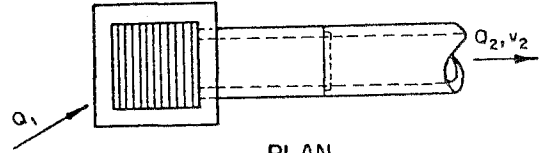

PLAN

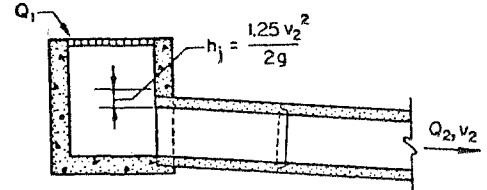

SECTION

CASE VI
INLET OR MANHOLE AT
BEGINNING OF LINE

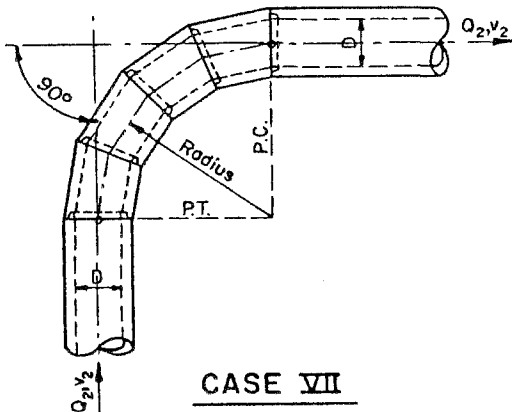

CASE VII

CONDUIT ON 90° CURVES *

NOTE: Head loss applied at P.C. for length of curve.

Radius = Dia. of Pipe $h_j = 0.50 \frac{v_2^2}{2g}$

Radius = (2-8) Dia. of Pipe $h_j = 0.25 \frac{v_2^2}{2g}$

Radius = (8-20) Dia. of Pipe $h_j = 0.40 \frac{v_2^2}{2g}$

Radius = Greater than 20 Dia. of Pipe $h_j = 0$

* When curves other than 90° are used, apply the following factors to 90° curves.

60° curve 85%

45° curve 70%

22½° curve 40%

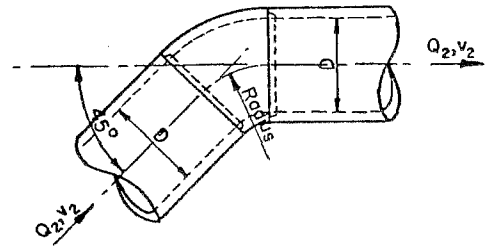

CASE VIII

BENDS WHERE RADIUS IS
EQUAL TO DIAMETER OF PIPE

NOTE: Head loss applied at beginning of bend

90° Bend $h_j = 0.50 \frac{v_2^2}{2g}$

60° Bend $h_j = 0.43 \frac{v_2^2}{2g}$

45° Bend $h_j = 0.35 \frac{v_2^2}{2g}$

22½° Bend $h_j = 0.20 \frac{v_2^2}{2g}$

SOURCE: City of Austin, Tx.

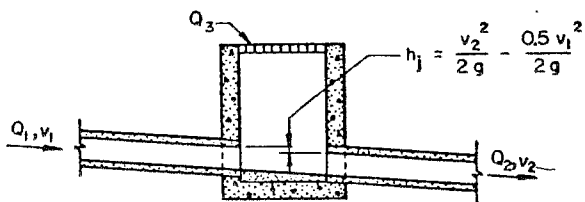
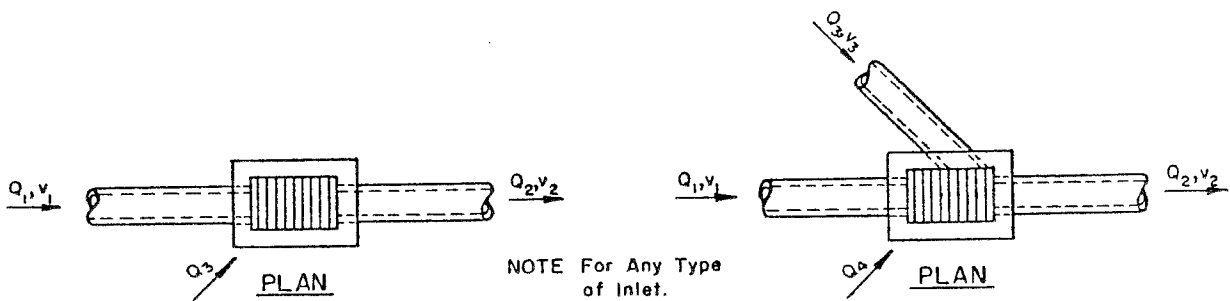

SECTION
CASE I
INLET ON MAIN LINE

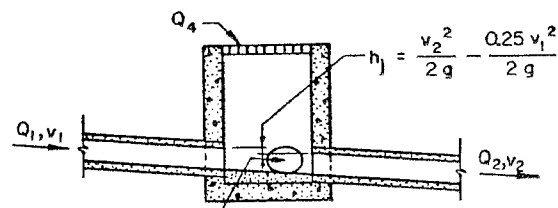

SECTION
CASE II
INLET ON MAIN LINE
WITH BRANCH LATERAL

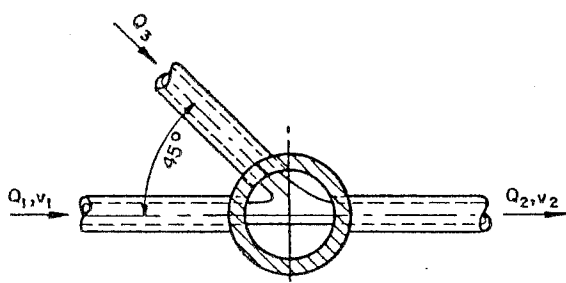

PLAN

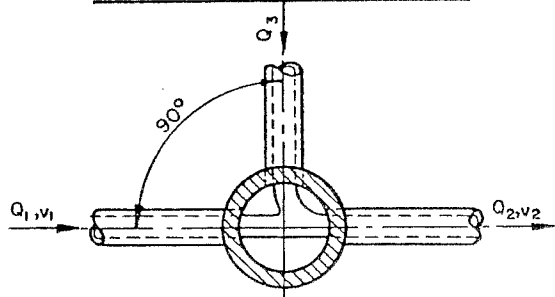

PLAN

NOTE:
60° Lateral $h_j = \frac{v_2^2}{2g} - \frac{0.35 v_1^2}{2g}$
22½° Lateral $h_j = \frac{v_2^2}{2g} - \frac{0.75 v_1^2}{2g}$

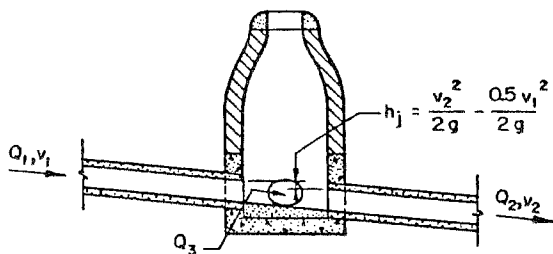

SECTION
CASE III
MANHOLE ON MAIN LINE
WITH 45° BRANCH LATERAL

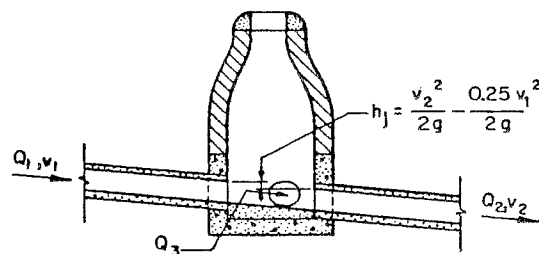

SECTION
CASE IV
MANHOLE ON MAIN LINE
WITH 90° BRANCH LATERAL

SOURCE: City of Austin, Tx.

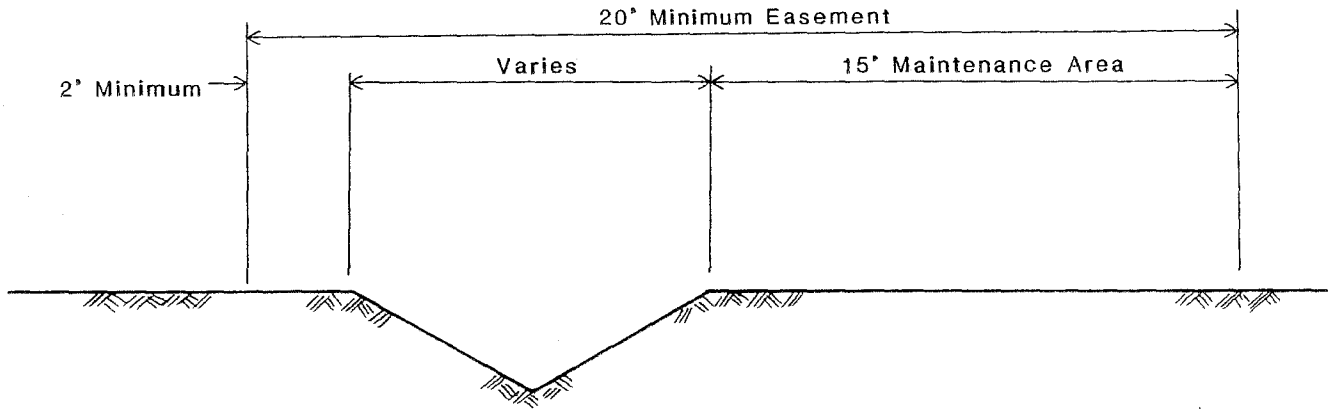

SMALL DITCH

GENERAL NOTES

- Utility crossings limited to one per block
- Access easements required every 600'
- Utilities shall not be located beneath a concrete bottom except at crossings
- Manholes not allowed in ditches

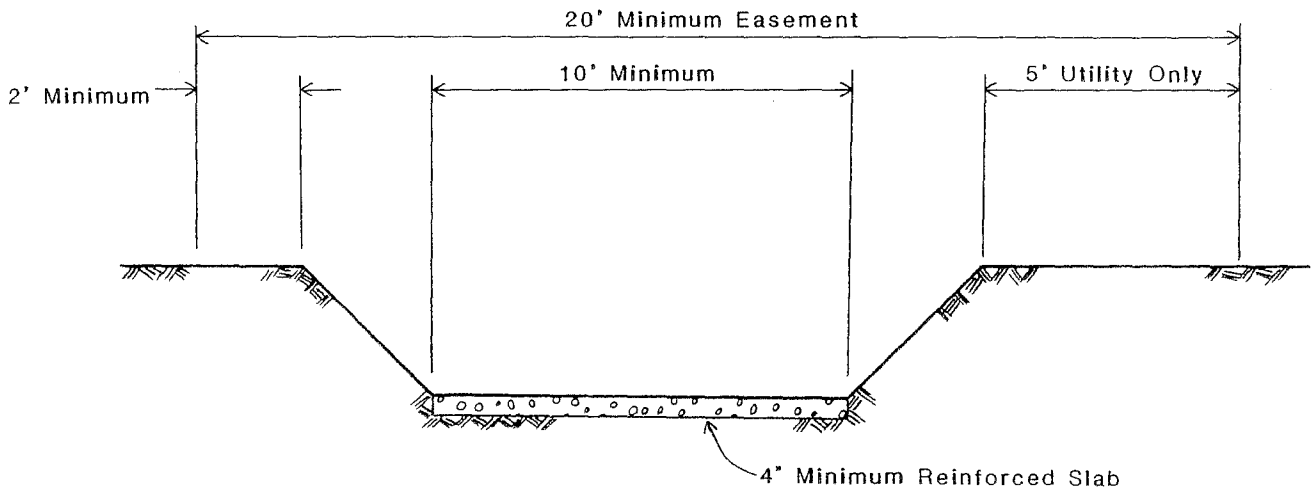

LARGE DITCH

SECTION IV - CULVERT HYDRAULICS

- 4.0 General
- 4.1 Inlet Control
- 4.2 Outlet Control
- 4.3 Headwalls and Endwalls
 - 4.3.1 General
 - 4.3.2 Conditions of Entrance
 - 4.3.2 Selection of Headwall or Endwall
- 4.4 Culvert Discharge Velocities
- 4.5 Computation Format
- 4.6 Culvert Types and Sizes
- 4.7 Fill Heights and Bedding
- 4.8 Types of Culvert Flow
- 4.9 Examples of Culvert Sizing Computations

SECTION IV - CULVERT HYDRAULICS

4.0 GENERAL

The function of a drainage culvert is to pass the design storm flow under a roadway or railroad without causing excessive backwater and without creating excessive downstream velocities. The design shall keep energy losses and discharge velocities within reasonable limits when selecting a structure.

Culvert flow may be separated into two major types of flow - inlet or outlet control. Under inlet control, the cross sectional area of the barrel, the shape of the inlet and the amount of ponding (headwater) at the inlet are primary design considerations. Outlet control is dependent upon the depth of water in the outlet channel (tailwater), the slope of the barrel, type of culvert material and length of the barrel.

4.1 INLET CONTROL

The size of a culvert operating with inlet control is determined by the size and shape of the inlet and the depth of ponding allowable (headwater) between the flowline elevation of a culvert and the elevation of a finished grade surface or surrounding buildings and facilities. See Figure 4-1. Factors not effecting inlet control design are the barrel roughness, slope and length and depth of the tailwater.

The headwater (HW) depth for a culvert of a given diameter or height (D) where a given discharge can be determined by obtaining the HW/D value from Hydraulic Engineering Circular #5, FWHA. A desirability maximum headwater for a culvert should not be greater than the diameter or height plus 2'. The elevation of adjacent facilities (i.e., buildings, etc.) must be reviewed for flooding.

4.2 OUTLET CONTROL

A culvert will operate under outlet control when the depth of the tailwater, the length, the slope or roughness of the culvert barrel act as the control on the quantity of water able to pass through a given culvert. See Figure 4-2. Energy head required for a culvert to operate under outlet control is comprised of velocity head (H_v), entrance loss (H_e) and friction loss (H_f). This energy head (H) is obtained from Hydraulic Engineering Circular #5, FWHA, and entrance loss coefficients from Table 4-1.

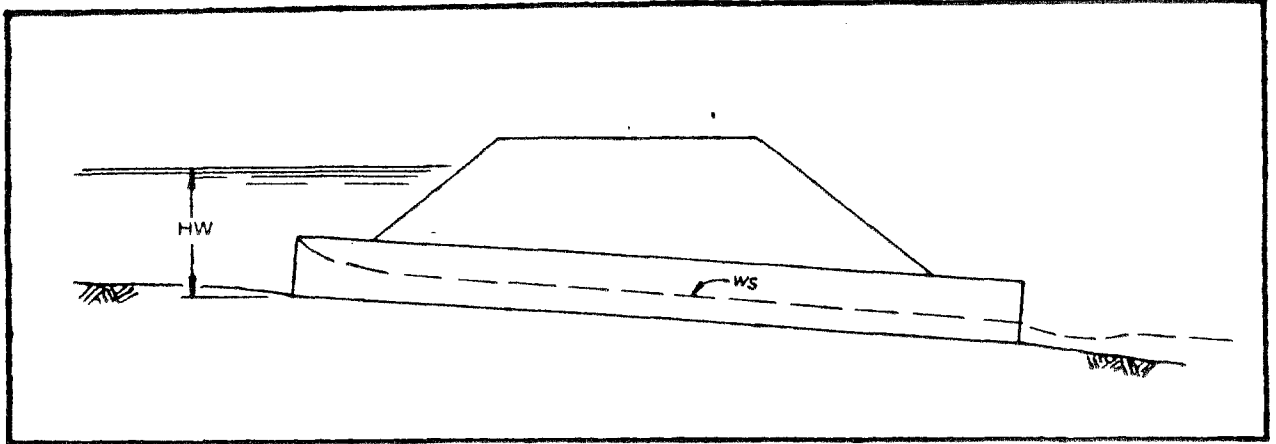

INLET CONTROL

4-1
FIGURE

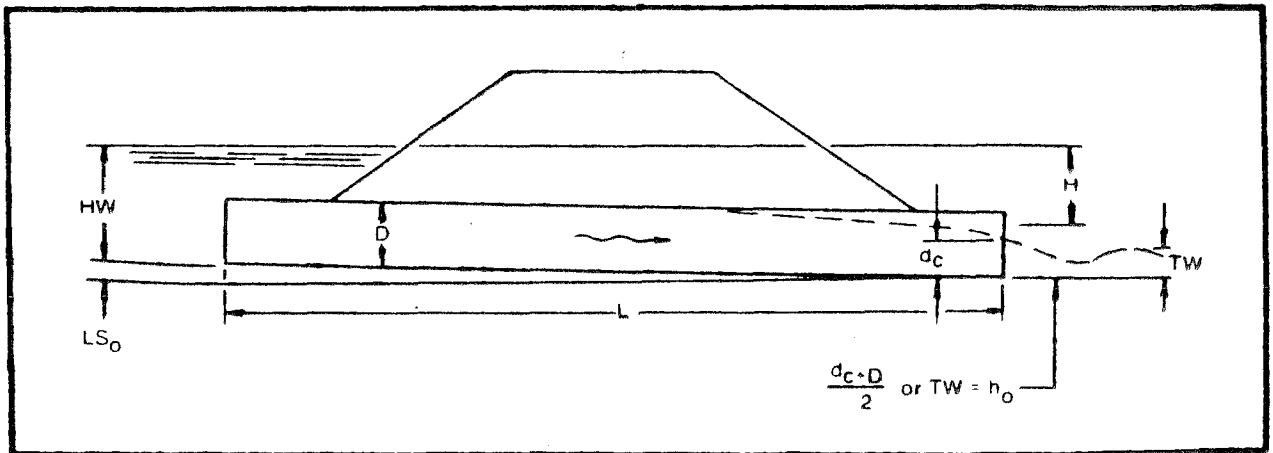

OUTLET CONTROL

4-2
FIGURE

The headwater depth (HW) at the culvert entrance is calculated by means of the following formula:

$$HW = H + h_o - LS_o$$

Where: H = energy head

L = length of culvert (ft.)

S_o = slope of barrel (feet per foot)

h_o = $\frac{dc + D}{2}$ or IW, whichever is greater

dc = critical depth of flow in the barrel.
Critical depth may be determined by using
Hydraulic Engineering Circular #5, FWHA.

D = height of pipe or box

IW = tailwater depth

The maximum desirable headwater depth for culverts operating under outlet control shall be the same as described in Section III.

See Section 4.8 for detailed types of culvert flow and Section 4.9 for examples of culvert sizing computations.

4.3 HEADWALLS AND ENDWALLS

4.3.1 GENERAL

The normal functions of properly designed headwalls and end walls are to anchor the culvert, to prevent movement due to the lateral pressures, to control erosion and scour resulting from excessive velocities and turbulence, and to prevent adjacent soil from sloughing into the waterway opening. Headwalls shall be constructed of reinforced concrete may either be straight parallel headwalls, flared headwalls, or warped headwalls with or without aprons as may be required by site conditions. Multi-barrel culvert crossings of roadways at an angle or 15° or greater shall be accompanied by adequate inlet and outlet control sections.

4.3.2 CONDITIONS AT ENTRANCE

It is important to recognize that the operation characteristics of a culvert may be completely changed by the shape or condition at the inlet or entrance. Design of culverts must involve consideration of energy losses than may occur at the entrance. The entrance head losses may be determined by the following equation:

$$h_e = K_e \frac{V_2^2}{2g} - \frac{V_1^2}{2g}$$

h_e = entrance head loss in feet

V_2 = velocity of flow in culvert

V_1 = velocity of approach in feet per sec.

K_e = entrance loss coefficient as shown in Table 4-1.

Table 4-1
 Values of Entrance Loss Coefficients " K_e "

<u>Type of Structure & Entrance Design</u>	<u>Value of K_e</u>
<u>Box, Reinforced Concrete</u>	
Submerged Entrance	
Parallel wing walls	0.5
Flared wing walls	0.4
Free Surface Flow	
Parallel wing walls	0.5
Flared wing walls	0.15
<u>Pipe, Concrete</u>	
Projecting from fill, socket end	0.2
Projecting from fill, square cut end	0.5
Headwall or headwall & wingwalls	.
socket end of pipe	0.2
square - edge	0.5
End - section conforming to fill slope	0.5
<u>Pipe, or Pipe-Arch, Corrugated Metal</u>	
Projecting from fill (no headwall	0.9
Headwall or headwall and wingwalls	
Square - edge	0.5
End - section conforming to fill	0.5

In order to compensate for the retarding effect on the velocity of approach in channels produced by the creation of the headwater pools at culvert entrances, the velocity of approach in the channel (V_a) shall be reduced by the factors as shown in Table 4-2.

Table 4-2

REDUCTION FACTORS FOR VELOCITY OF APPROACH

Velocity of Approach " V_a " (FPS)	Desc. of Conditions	Used in Formula for h_e
0-6	All culverts	$V_1 = V_a$
Above 6	Good alignment of the approach channel; headwater pool permissible within the right-of-way.	$V_1 = 0.5$
Above 6	Good alignment of the approach channel; channel slopes have been lined; limited backwater pool permissible within the right-of-way	$V_1 = 0$

4.3.3 SELECTION OF HEADWALL OR ENDWALL

In general the following guidelines should be used in the selection of the type of headwalls or endwalls.

- (1) Approach velocities are low (below 6 feet per sec.).
- (2) Backwater pools may be permitted.
- (3) Approach channel is undefined.
- (4) Ample right-of-way or easement is available.
- (5) Downstream channel protection is not required.

Flared Headwall and End Wall

- (1) Channel is well defined.

- (2) Approach velocities are between 6 and 10 feet per second.
- (3) Medium amounts of debris exists.

The wings of flared walls should be located with respect to the direction of the approaching flow instead of the culvert axis.

Warped Headwall and End Wall

- (1) Channel is well defined and concrete lined.
- (2) Approach velocities are between 8 and 20 feet per second.
- (3) Medium amounts of debris exist.

These headwalls are effective with drop down aprons to accelerate flow through the culvert, and are effective for transitioning flow from closed conduit flow to open channel flow. This type of headwall should be used only where the drainage structure is large and right-of-way or easement is limited.

4.4 CULVERT DISCHARGE VELOCITIES

The velocity of discharge from culverts should be limited as shown in Table 4-3. Consideration must be given to the effect of high velocities, eddies, or other turbulence on the natural channel, downstream property, and roadway embankment.

Table 4-3

Culvert Discharge - Velocity Limitations

<u>Downstream Condition</u>	<u>Maximum Allowable Discharge Velocity (FPS)</u>
Earth	6 FPS
Sod Earth	8 FPS
Paved or Riprap Apron	15 FPS
Shale	10 FPS
Rock	15 FPS

4.5 COMPUTATION FORMAT

Figure 4-3 developed by the Federal Highway Administration is to be used for culvert design. Design methods utilizing computers may be used with prior approval of the City Engineer.

Figures 4-18. Box culverts shall be structurally designed to accommodate earth and live load to be imposed upon the culvert. Refer to the Arkansas Highway and Transportation Department's Standard Plans for Typical Box Culvert Designs.

Where culverts under railroad facilities are necessary, the designer shall obtain approval from the affected railroad.

4.8 TYPES OF CULVERT FLOW

Type I	Flowing Part Full with Outlet Control and Tailwater Depth Below Critical Depth. (Figure 4-3)
Type II	Flowing Part Full with Outlet Control and Tailwater Depth Above Critical Depth. (Figure 4-4)
Type III	Flowing Part Full with Inlet Control. (Figure 4-5)
Type IVA	Flowing Full with Submerged Outlet. (Figure 4-6)
Type IVB	Flowing Full with Partially Submerged Outlet. (Figure 4-7)

Type 1
Culvert Flowing Part Full
With Outlet Control and Tailwater Depth
Below Critical Depth

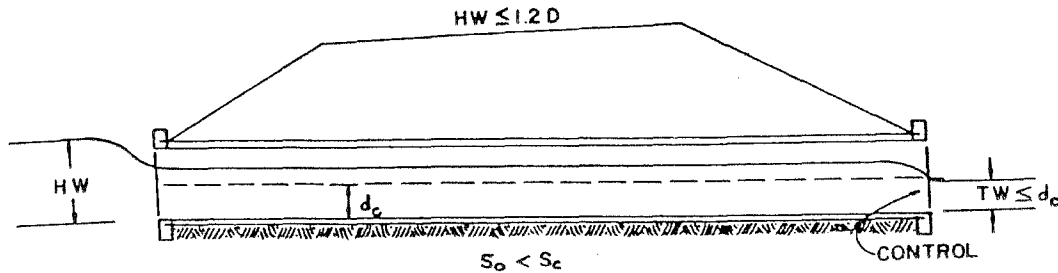

Conditions

The entrance is unsubmerged ($HW \leq 1.2D$), the slope at design discharge is sub-critical ($S_o < S_c$), and the tailwater is below critical depth ($TW \leq d_c$).

The above condition is a common occurrence where the natural channels are on flat grades and have wide, flat flood plains. The control is critical depth at the outlet.

In culvert design, it is generally considered that the headwater pool maintains a constant level during the design storm. If this level does not submerge the culvert inlet, the culvert flows part full.

If critical flow occurs at the outlet the culvert is said to have "Outlet Control." A culvert flowing part full with outlet control will require a depth of flow in the barrel of the culvert greater than critical depth while passing through critical depth at the outlet.

The capacity of a culvert flowing part full with outlet control and tailwater depth below critical depth shall be governed by the following equation when the approach velocity is considered zero.

$$HW = d_c + \frac{V_c^2}{2g} + h_e + h_f - S_o L$$

HW = Headwater depth above the invert of the upstream end of the culvert in feet. Headwater must be equal to or less than 1.2D or entrance is submerged and Type 4 operation will result.

d_c = Critical depth of flow in feet = $\sqrt[3]{\frac{q^2}{32.2}}$

D = Diameter of pipe or height of box.

q = Discharge in cfs per foot.

V_c = Critical velocity in feet per second occurring at critical depth.

h_e = Entrance head loss in feet.

$$h_e = K_e \left(\frac{v_c^2}{2g} \right)$$

SOURCE: City of Austin, Tx. Fig. 4-3 - 4-8

- K_e = Entrance loss coefficient
 h_f = Friction head loss in feet = $S_f L$.
 S_f = Friction slope or slope that will produce uniform flow. For Type I operation the friction slope is based upon $1.1 d_c$
 S_o = Slope of culvert in feet per foot.
 L = Length of culvert in feet.

Type II

Culvert Flowing Part Full With Outlet Control And Tailwater Depth Above Critical Depth

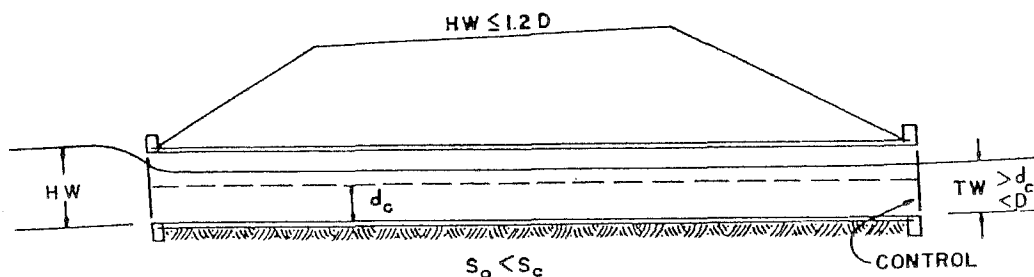

Conditions

The entrance is unsubmerged ($HW \leq 1.2D$), the slope at design discharge is subcritical ($S_o < S_c$), and the tailwater is above critical depth ($TW > d_c$).

The above condition is a common occurrence where the channel is deep, narrow and well defined.

If the headwater pool elevation does not submerge the culvert inlet, the slope at design discharge is subcritical, and the tailwater depth is above critical depth the control is said to occur at the outlet; and the capacity of the culvert shall be governed by the following equation when the approach velocity is considered zero.

$$HW = TW + \frac{V_{TW}^2}{2g} + h_e + h_f - S_o L$$

HW = Headwater depth above the invert of the upstream end of the culvert in feet. Headwater depth must be equal to or less than $1.2D$ or entrance is submerged and Type IV operation will result.

TW = Tailwater depth above the invert of the downstream end of the culvert in feet.

V_{TW} = Culvert discharge velocity in feet per second at tailwater depth.

h_e = Entrance head loss in feet.

$$h_e = K_e \left(\frac{V_{TW}^2}{2g} \right)$$

K_e = Entrance loss coefficient

h_f = Friction head loss in feet = $S_f L$

S_f = Friction slope or slope that will produce uniform flow. For Type II operation the friction slope is based upon TW depth.

S_o = Slope culvert in feet per foot.

L = Length of culvert in feet.

Type III

Culvert Flowing Part Full With Inlet Control

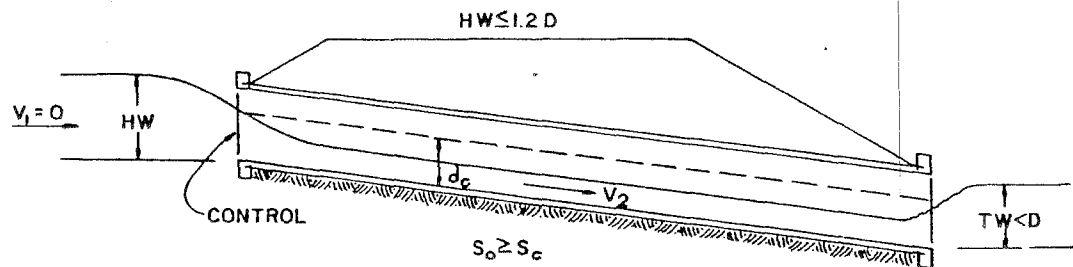

Conditions

The entrance is unsubmerged ($HW \leq 1.2D$) and the slope at design discharge is equal to or greater than critical (Supercritical) ($S_o \geq S_c$).

This condition is a common occurrence for culverts in rolling or mountainous country where the flow does not submerge the entrance. The control is critical depth at the entrance.

If critical flow occurs near the inlet, the culvert is said to have "Inlet Control". The maximum discharge through a culvert flowing part full occurs when flow is at critical depth for a given energy head. To assure that flow passes through critical depth near the inlet, the culvert must be laid on a slope equal to or greater than critical slope for the design discharge. Placing culverts which are to flow part full on slopes greater than critical slope will increase the outlet velocities

but will not increase the discharge. The discharge is limited by the section near the inlet at which critical flow occurs.

The capacity of a culvert flowing part full with control at the inlet shall be governed by the following equation when the approach velocity is considered zero.

$$HW = d_c + \frac{V_2^2}{2g} + K_e \frac{V_2^2}{2g}$$

HW = Headwater depth above the invert of the upstream end of the culvert in feet. Headwater depth must be equal to or less than 1.2D or entrance is submerged and Type IV operation will result.

d_c = Critical depth of flow in feet = $\sqrt[3]{\frac{q^2}{32.2}}$

q = Discharge in cfs per foot.

V_2 = Velocity of flow in the culvert in feet per second.

The velocity of flow varies from critical velocity at the entrance to uniform velocity at the outlet provided the culvert is sufficiently long. Therefore, the outlet velocity is the discharge divided by the area of flow in the culvert.

K_e = Entrance loss coefficient

Type IV-A

Culvert Flowing Full With Submerged Outlet

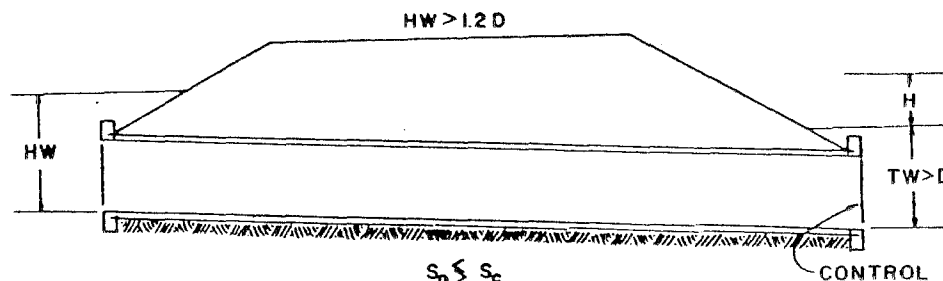

Conditions

(Submerged Outlet)

The entrance is submerged ($HW > 1.2D$). The tailwater completely submerges the outlet.

Most culverts flow with free outlet, but depending on topography, a tailwater pool of a depth sufficient to submerge the outlet may form at some installation. Generally, these will be

considered at the outlet. For an outlet to be submerged, the depth at the outlet must be equal to or greater than the diameter of pipe or height of box. The capacity of a culvert flowing full with a submerged outlet shall be governed by the following equation when the approach velocity is considered zero. Outlet Velocity is based on full flow at the outlet.

$$HW = H + TW - S_o L$$

HW = Headwater depth above the invert of the upstream end of the culvert.
Headwater depth must be greater than 1.2D for entrance to be submerged.

H = Head for culvert flowing full.

TW = Tailwater depth in feet.

S_o = Slope of culvert in feet per foot.

L = Length of culvert in feet.

Type IV-B
Culvert Flowing Full
With Partially Submerged Outlet

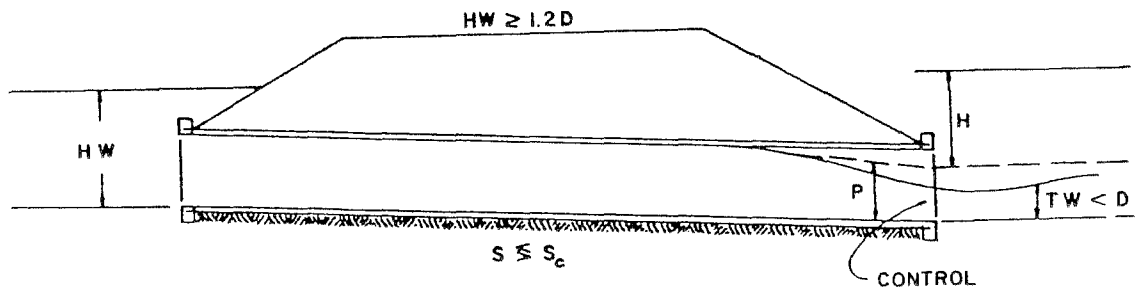

Conditions

(Partially Submerged Outlet)

The entrance is submerged ($HW > 1.2D$). The tailwater depth is less than D ($TW < D$).

The capacity of a culvert flowing full with a partially submerged outlet shall be governed by the following equation when the approach velocity is considered zero. Outlet velocity is based on

critical depth if TW depth is less than critical depth. If TW depth is greater than critical depth, outlet velocity is based on TW depth.

$$HW = H + P - S_o L$$

HW = Headwater Depth above the invert of the upstream end of the culvert.
Headwater depth must be greater than 1.2D for entrance to be submerged.

H = Head for culverts flowing full.

$$P = \text{Pressure line height} = \frac{d_c + D}{2}$$

d_c = Critical depth in feet.

D = Diameter or height of structure in feet.

S_o = Slope of culvert in feet per foot.

L = Length of culvert in feet.

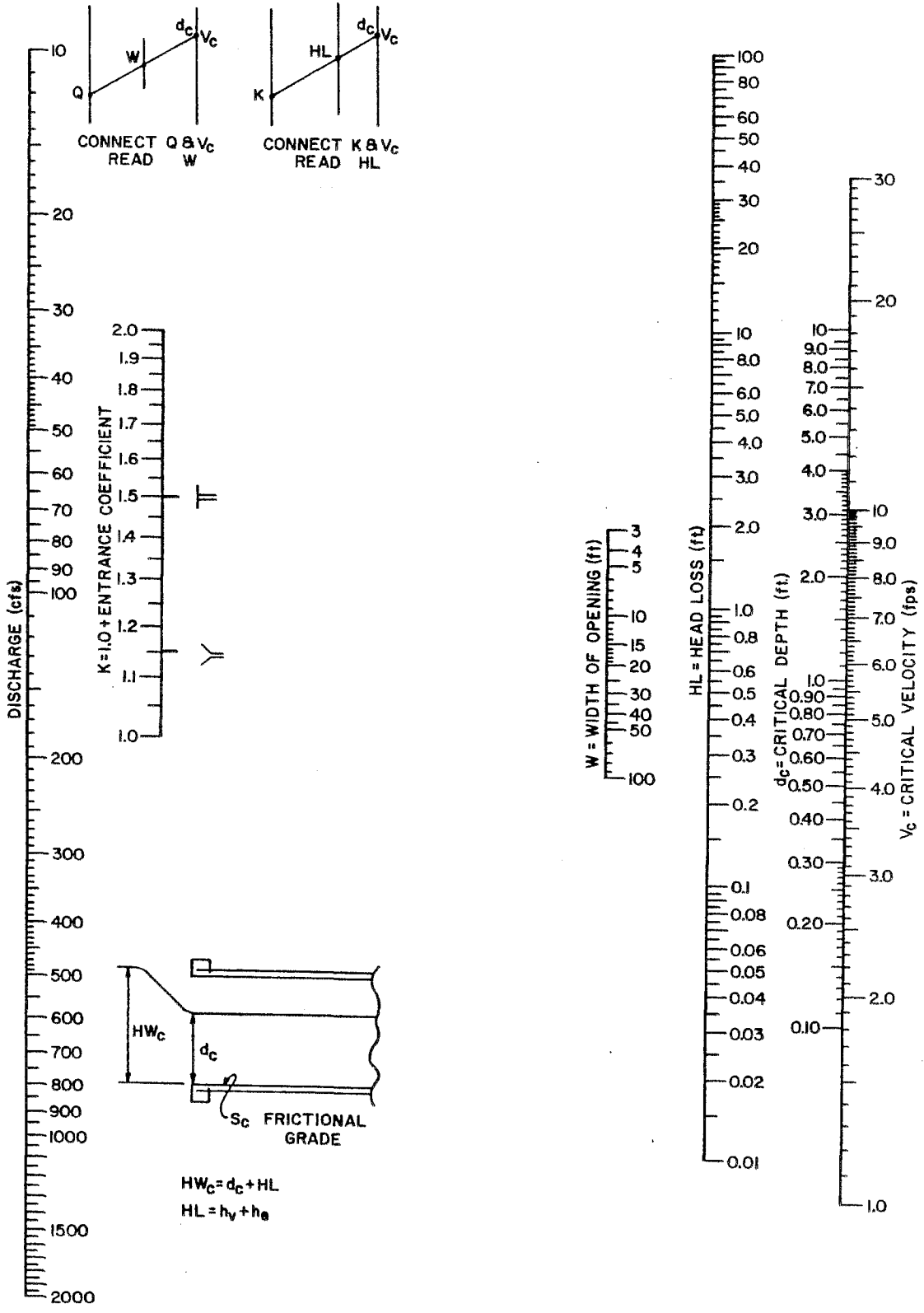

SOURCE: TEXAS HIGHWAY DEPT. Fig. 4-9 - 4-16

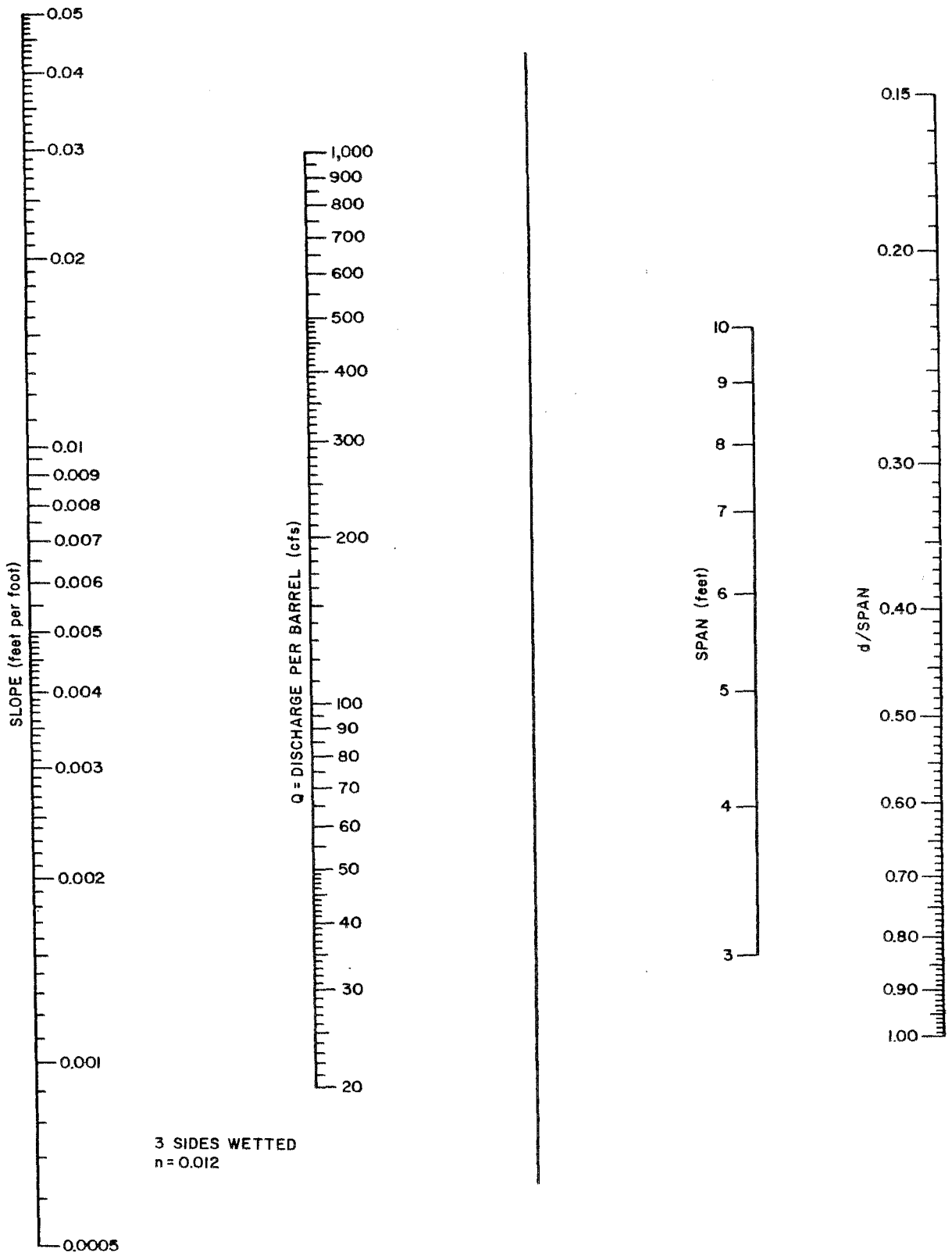

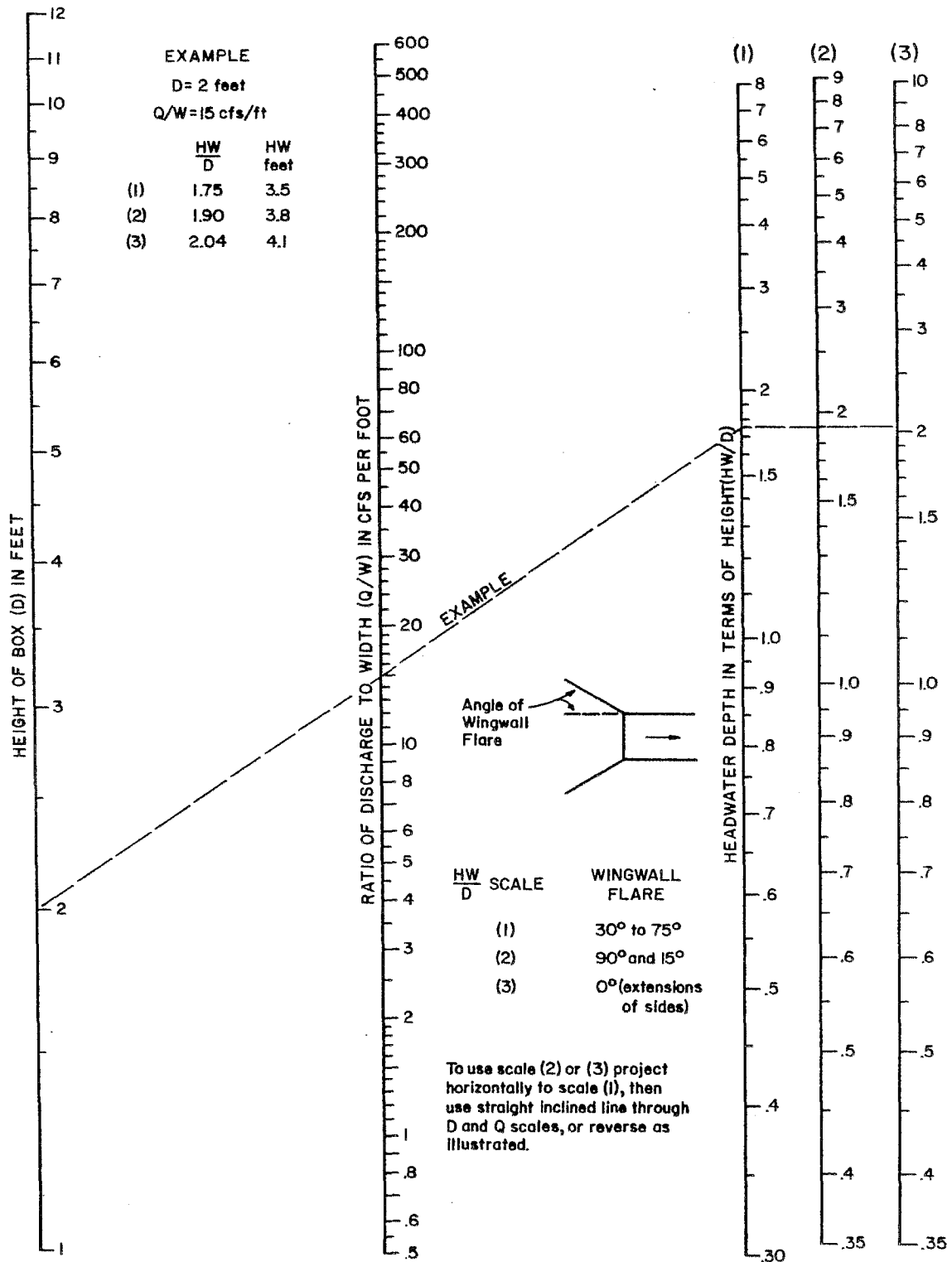

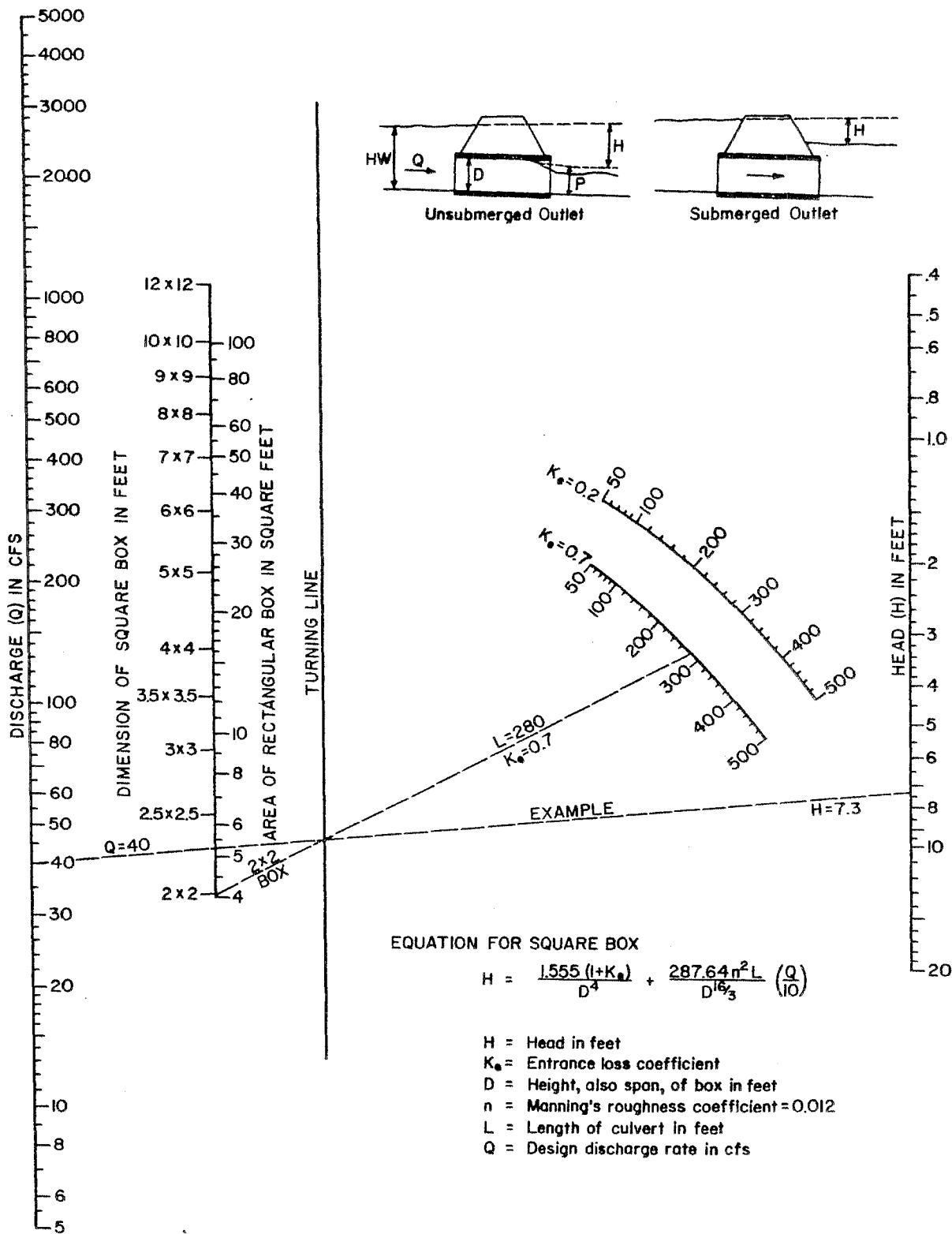

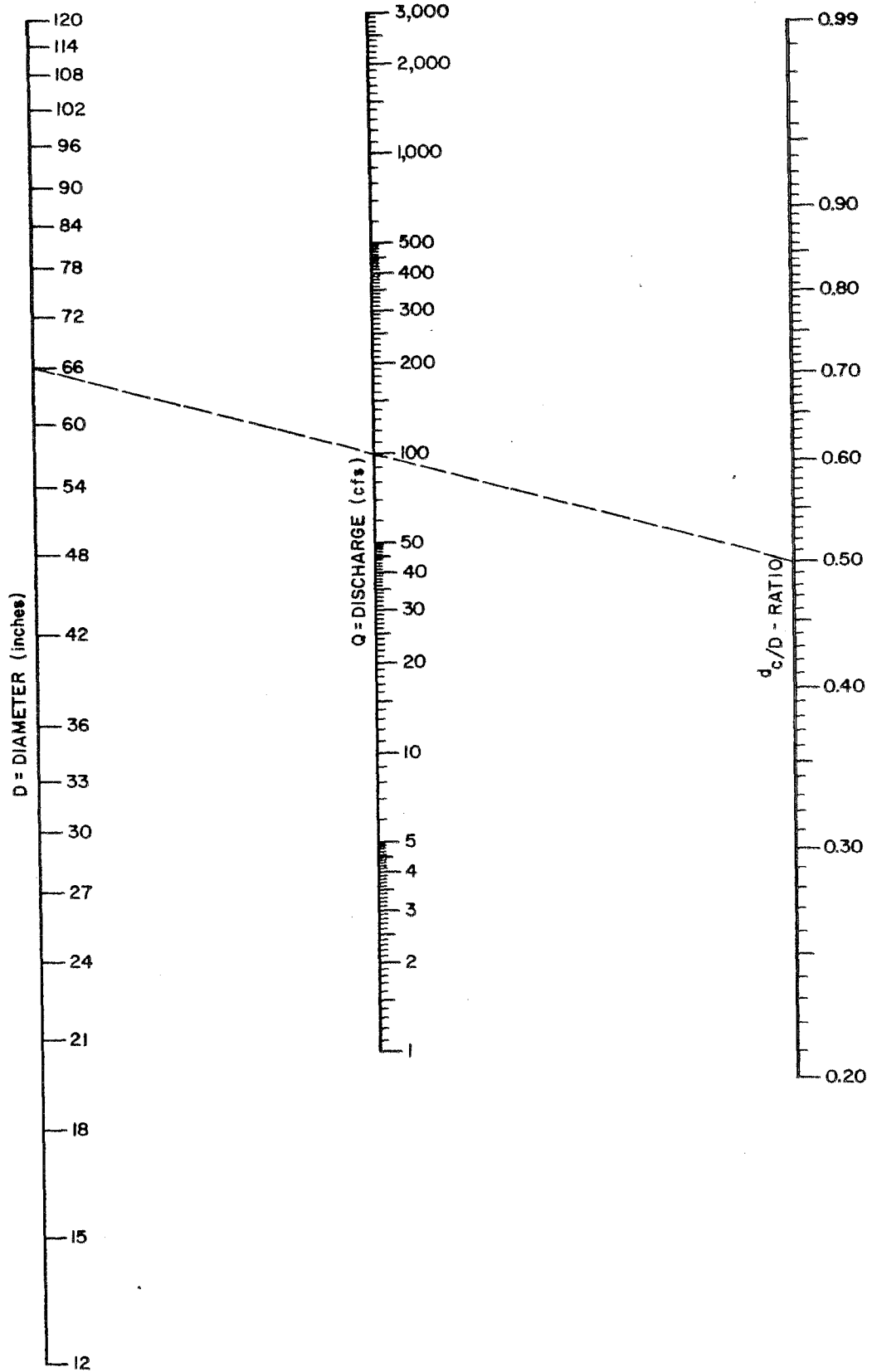

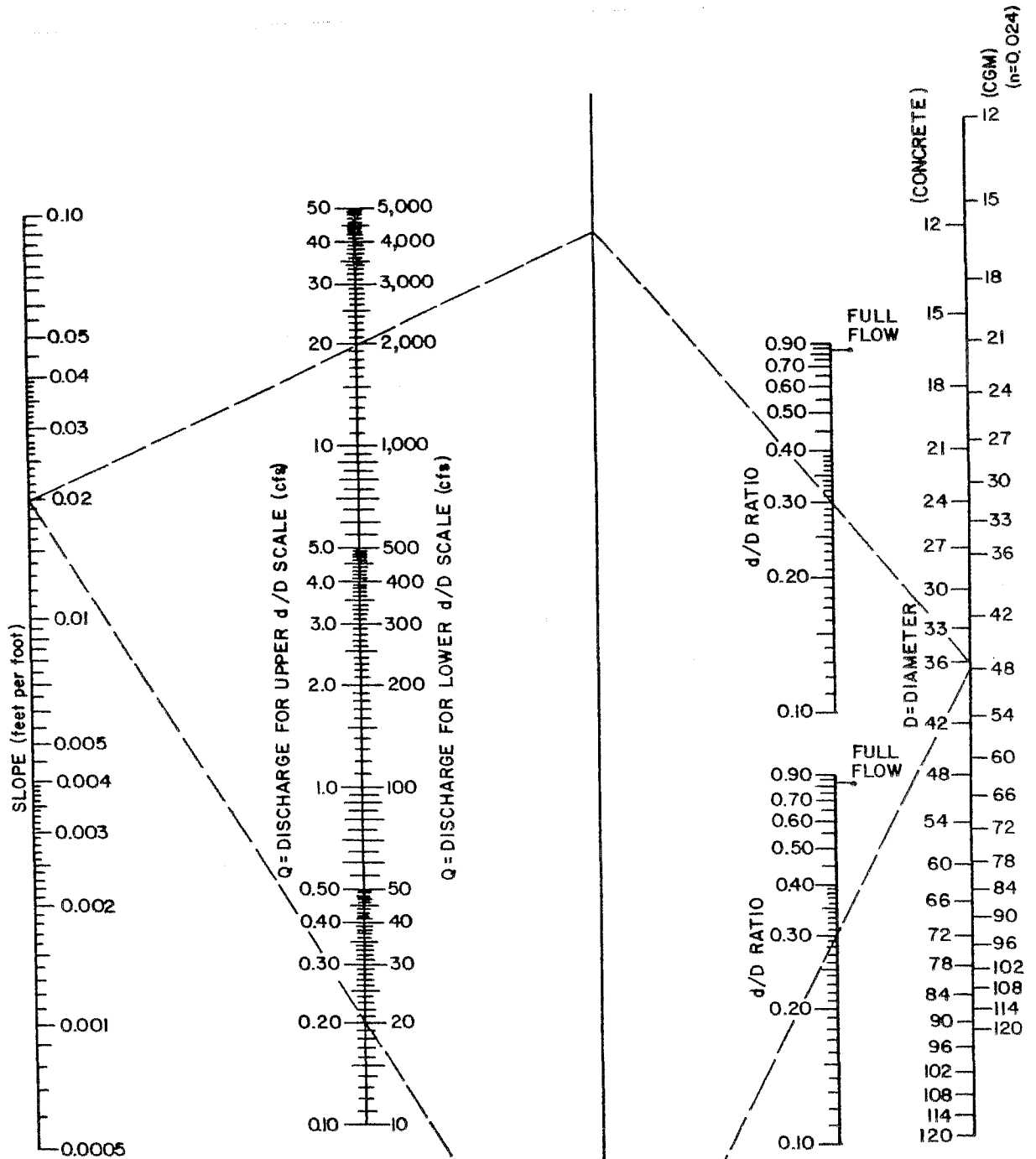

EXAMPLE

GIVEN: $S = 0.02$ FIND: $d/D =$
 $Q = 20 \text{ cfs}$ $d =$
 $D = 36'' \text{ (CONCRETE)}$

SOLUTION

$d/D = 0.30$
 $d = 0.30 \times 3' = 0.9'$

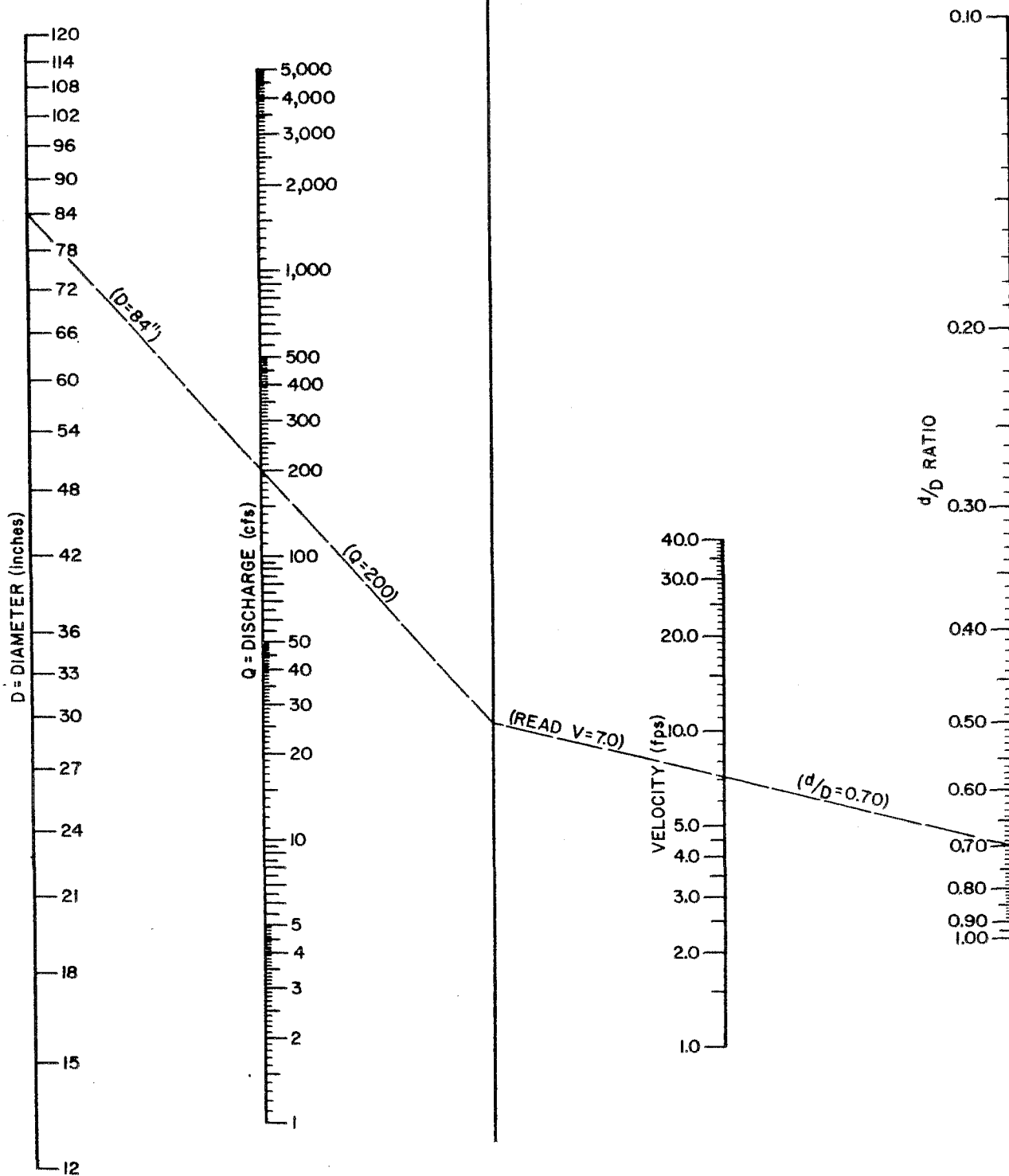

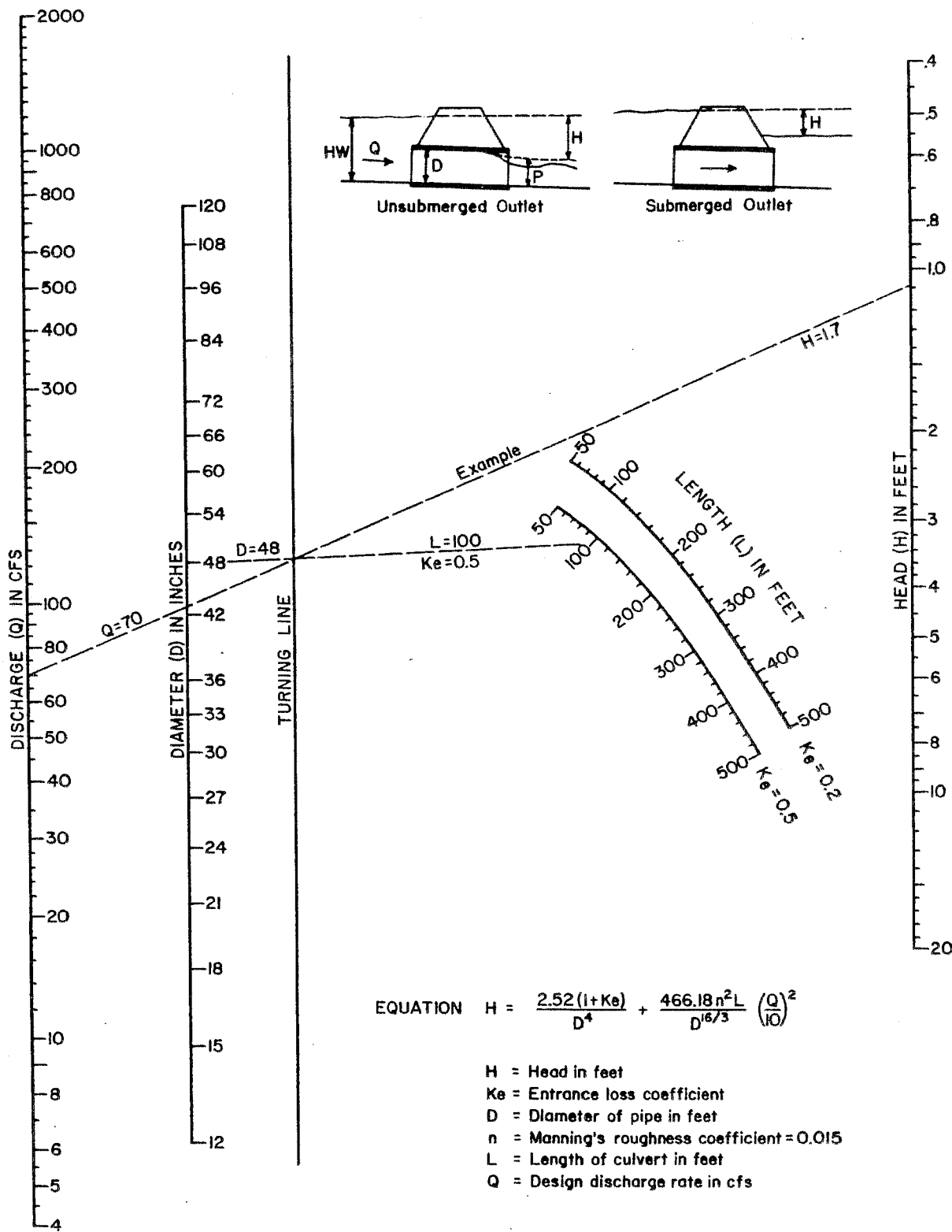

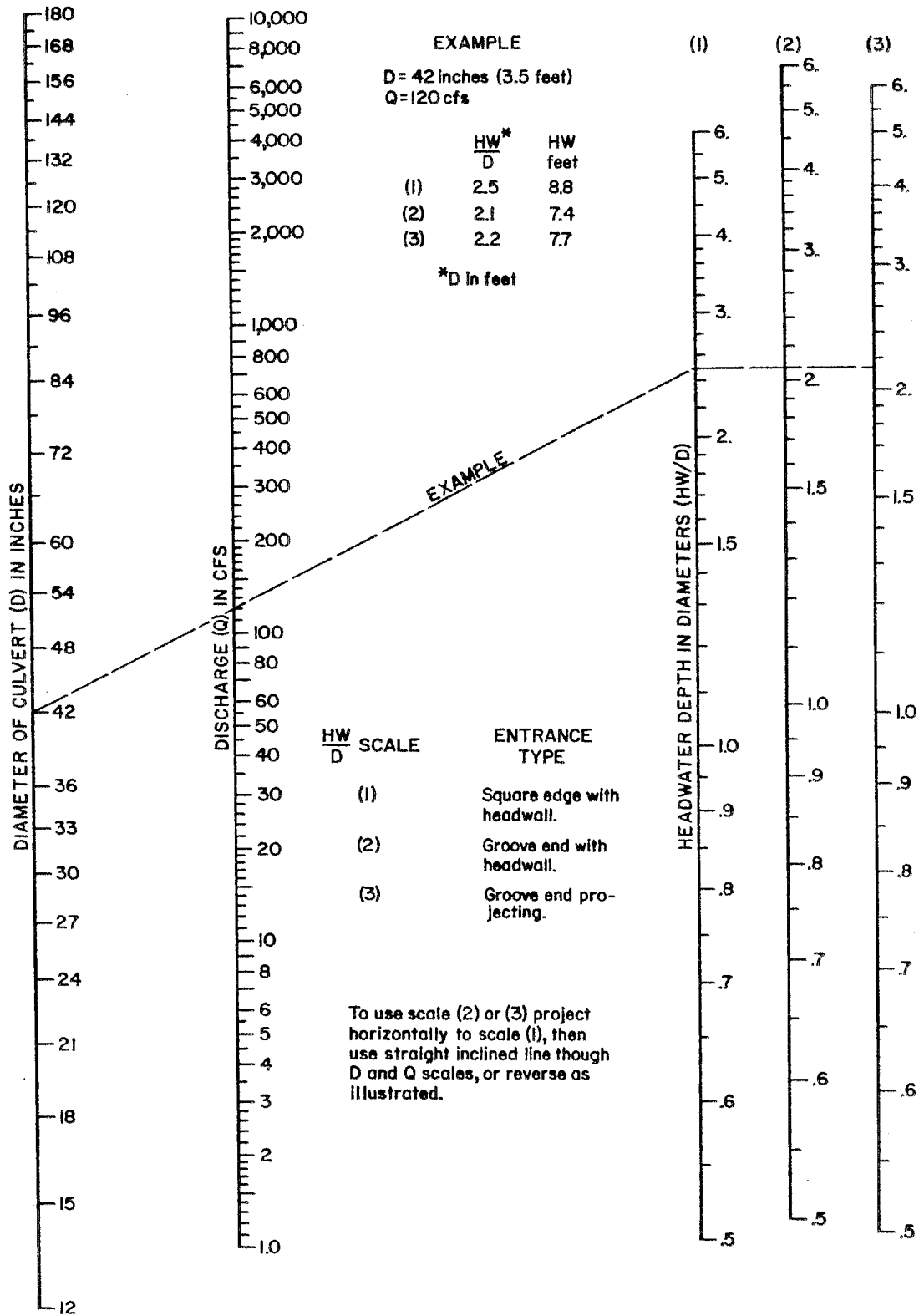

4.9 Examples of Culvert Sizing Computations

Example 1:

Given:

$$Q = 326 \text{ cfs}$$

$$S_o = 0.002 \text{ ft./ft.}$$

Allowable headwater depth, HW = 6.0 ft.

Allowable outlet velocity, V = 8.0 fps

Length of Culvert, L = 200 ft. \pm

Tailwater depth, TW = 2.6 ft.

Flared Wingwalls

Required: The most economical concrete box culvert that will pass the design discharge.

Solution:

- (1) Enter Figure 4-9 with $Q = 326$ and $V_c = 8.0$ and read approximate width of opening. $W = 20'$, and $d_c = 2.0'$, then connect K value for flared wings = 1.15 with $V_c = 8.0$ and read $HL = 1.2'$. Then

$$HW_c = d_c + HL \text{ or } 2.0 + 1.2 = 3.2'$$

From the above calculations it appears that a culvert having a width of 20' and a height of 3.2' will adequately pass the design discharge. In order to fit a standard design it is decided to try a 4 - 5' x 4' multiple box culvert.

- (2) The next step is to determine the type of culvert operation. This is accomplished by first determining the critical slope by entering Figure 4-10 with $\frac{d_c}{W} = \frac{2}{5} = 0.4$ and $W = 5$ and establishing a point on the turning line. Connect the point on turning line with $Q = \frac{326}{4} = 81.5$ and read $S_c = 0.0037$

We have now assembled the following data:

Existing Channel	Culvert
$S_o = 0.002 \text{ ft./ft.}$	$S_c = 0.0037$
$TW = 2.6'$	$d_c = 2.0'$
	$D = 4.0'$

Also we know the following:

$$S_o < S_c$$

$$TW > d_c$$

$$TW < D$$

This culvert will function as a Type II operation with the control at the outlet providing $HW < 1.2D$.

- (3) The next step is to determine the actual headwater depth and to confirm the Type II operation.

$$HW = TW + \left(\frac{V_{TW}}{2g} \right)^2 + h_e + h_f - S_o L$$

SOURCE: City of Austin, Tx. 4.9 Examples 1-6

$$TW = 2.6'$$

$$\left(\frac{V_{TW}}{2g}\right)^2 = \frac{\left(\frac{Q}{A}\right)^2}{64.4} = \frac{\left(\frac{326}{20 \times 2.6}\right)^2}{64.4} = \frac{39.31}{64.4} = 0.61'$$

$$h_e = K_e \left(\frac{V_{TW}}{2g}\right)^2 = 0.15 \times 0.61 = 0.09$$

$$h_f = S_f L \text{ Enter Figure 4-10 with}$$

$$\frac{d_{TW}}{W} = \frac{2.6}{5} = 0.52, W = 5 \text{ and}$$

$$Q = \frac{326}{4} = 81.5 \text{ and read } S_f = 0.0019 \text{ ft./ft.}$$

$$h_f = 0.0019 \times 200 = 0.38'$$

$$S_o L = 0.002 \times 200 = 0.40'$$

$$HW = 2.60 + 0.61 + 0.09 + 0.38 - 0.40 = 3.28'$$

The computation of the headwater depth confirms the Type II operation since $HW \leq 1.2D$.

$$(4) \text{ The outlet velocity} = \frac{Q}{A} = \frac{326}{20 \times 2.6} = 6.3 \text{ fps}$$

Since the calculated $HW = 3.27'$ which is substantially less than the allowable $HW = 6.0'$ and the calculated $V = 6.3 \text{ fps}$ which is less than the allowable $V = 8.0 \text{ fps}$, the above structure is considered uneconomical.

Example 2:

Given: Same data as in Example 1.

Try 2 - 6.5' x 4' multiple box culvert.

Solution:

$$(1) \text{ From Figure 4-9 } d_c = 2.65, V_c = 9.30$$

$$(2) \text{ From Figure 4-10 } S_c = 0.0035 \text{ ft./ft.}$$

$$\text{since } S_o < S_c$$

$$\text{and } TW < d_c$$

We have a Type I operation with control at the outlet providing $HW \leq 1.2D$.

$$(3) \text{ Check HW for Type I operations:}$$

$$HW = d_c + \frac{V_c^2}{2g} + h_e + h_f - S_o L$$

$$d_c = 2.65'$$

$$\frac{V_c^2}{2g} = \frac{(9.30)^2}{64.4} = 1.34'$$

$$h_e = K_e \left(\frac{V^2}{2g}\right) = 0.15 \times 1.34' = 0.20'$$

$h_f = S_f L$ Enter Figure with

$$\frac{1.1d_c}{W} = \frac{1.1 \times 2.65}{6.5} = 0.45, W = 6.5'$$

$$Q = \frac{326}{2} = 163 \text{ and read } S_f = 0.00275 \text{ ft./ft.}$$

$$h_f = S_f L = 0.00275 \times 200 = 0.55'$$

$$S_o L = 0.002 \times 200 = 0.40'$$

$$HW = 2.65 + 1.34 + 0.20 + 0.55 - 0.40 = 4.34'$$

Since $HW < 1.2D$ the installation will function as a Type I operation.

$$(4) \text{ Outlet Velocity} = V_c = 9.30 \text{ fps.}$$

HW is still lower than the allowable $HW = 6.0'$; however, the outlet velocity is greater than the allowable which was assumed to be 8 fps. The designer has the choice to provide riprap in the downstream channel, select a multiple box culvert of greater width or consider Type IV operation.

Example 3:

Given: Same data as in Example 1.

Required: Multiple Box Culvert for Type IV operation.

Solution:

For the given data let us select a 2 - 5' x 4' multiple box culvert. HW must be equal to or greater than 1.2D, or $HW = 1.2 \times 4.0 = 4.8'$ minimum. A partially submerged outlet (Type IV-B) will be considered. Under these conditions:

$$HW = H + P - S_o L$$

- (1) Area of one barrel = $5 \times 4 = 20$ sq. ft. Length of Culvert = 200 ft. K_e (Flared Wingwalls) = 0.4

$$Q \text{ per barrel} = \frac{326}{2} = 163 \text{ cfs}$$

- (2) Use Figure 4-12. Connect area of one barrel - 20 sq. ft. with 200 ft. length on $K_e = 0.4$ scale. The position of $K_e = 0.4$ must be interpolated between the limits $K_e = 0.2$ and $K_e = 0.7$. Mark point on turning line. Connect this point with $Q = 163$ and read $H = 2.3'$.

- (3) According to the definition,

$$P = \frac{d_c + D}{2}$$

Enter Figure 4-9 with $Q = 326$, $W = 10$ and read $d_c = 3.1'$

$$\text{Then } P = \frac{3.1 + 4.0}{2} = 3.55'$$

and $HW = 2.3 + 3.55 - (0.002 \times 200)$

$$HW = 5.45'$$

- (4) V (outlet) = $\frac{Q}{A} = \frac{326}{10 \times 3.1} = 10.5$ fps (concrete apron req'd.)

Note: Had TW been higher than D we would have had a submerged outlet and Type IV - A Flow would have controlled

$$HW = H + TW - S_o L \text{ and } V \text{ (outlet)} = \frac{Q}{A}$$

Example 4:

Given: To illustrate Type III operation assume the same data as in Example 1 except that $S_o = 0.005$ and the allowable outlet velocity = 10.0 fps.

Required: To determine the size of concrete box culvert.

Solution:

- (1) Enter Figure 4-9 with $Q = 326$ cfs and $V_c = 10.0$ fps and read $W = 10'$, $d_c = 3.1'$ and $HL = 1.3'$. Then

$$HW_c = d_c + HL = 3.1 + 1.3 = 4.4'$$

- (2) 10' x 5' single box culvert.

To determine the type of operation first find S_c by entering Figure 4-10 with $\frac{d_c}{W} = \frac{3.1}{10} = 0.31$, $W = 10'$ and establish a point on the turning line. Connect this point with $Q = 326$ cfs and read $S_c = 0.00295$ ft./ft.

We now have assembled the following data:

Existing Channel	Culvert
$S_o = 0.005$ ft./ft.	$S_c = 0.00295$ ft./ft.
$TW = 2.6'$	$d_c = 3.1'$

Since $S_o > S_c$
and $TW < D$

indications are the structure will function as Type III operation providing the $HW < 1.2D$.

- (3) For Type III operation the control is critical depth at the entrance and

$$HW = \frac{HW}{D} \text{ (from Nomograph) } \times D$$

check HW:

Enter Figure 4-11 with $\frac{Q}{W} = \frac{326}{10} = 32.6$ and $D = 5'$

and determine $\frac{HW}{D} = 1.0$

Then $HW = 1.0 \times D = 1.0 \times 5 = 5'$

- (4) The velocity for Type III culverts varies from critical velocity at the entrance to uniform velocity at the outlet provided the culvert is sufficiently long. We assume in this example that the outlet velocity is equal to the uniform velocity which is computed as follows:

Enter Figure 4-10 with $S_o = 0.005$, $Q = 326$ and $W = 10$ and determine $\frac{d}{W} = 0.26$

$$d = 0.26W = 0.26 \times 10 = 2.6$$

$$A = 10 \times 2.6 = 26.0 \text{ sq. ft.}$$

$$V \text{ (uniform)} = \frac{Q}{A} = \frac{326}{26.0} = 12.5 \text{ fps (Outlet requires riprap)}$$



Example 5:

Given:

$$Q = 326 \text{ cfs}$$

$$S_o = 0.002 \text{ ft./ft.}$$

$$\text{Allowable headwater depth, HW} = 6.5 \text{ ft.}$$

$$\text{Allowable outlet velocity, } V = 8.0 \text{ fps}$$

$$\text{Length of Culvert, } L = 200 \text{ ft. } \pm$$

$$\text{Tailwater depth, TW} = 2.6 \text{ ft.}$$

Square edge with headwall

Required: Determine size of concrete pipe culvert to pass the design discharge.

Solution:

(1) Use Figure 4-17, connect $\frac{HW}{D} = 1.2$ with $Q = 326$ and read approximate opening required = 80 inches. Since the allowable HW is restricted to 6.5' and HW for 80" pipe = $1.2 \times 6.7 = 8.0'$ the designer tries 2 - 60" pipes, and $HW = 1.2 \times 5.0 = 6.0'$.

(2) Use Figure 4-13; connect $Q = \frac{326}{2} = 163$ with $D = 60''$ and read $\frac{d_c}{D} = 0.73$.

$$d_c = 0.73D = 0.73 \times 5.0 = 3.65'$$

(3) Use Figure 4-14; connect 60" with $\frac{d_c}{D} = 0.73$ and intersect turning line. Connect turning line with $Q = 163$ and determine $S_c = 0.0046$ for concrete pipe.

We have now assembled the following data:

Existing Channel	Culvert
$S_o = 0.002 \text{ ft./ft.}$	$S_c = 0.0046 \text{ ft./ft. (Conc.)}$
$TW = 2.6'$	$d_c = 3.65'$
	$D = 5.0'$

Since $S_o < S_c$ and $TW < d_c$, we have a Type I operation with control at the outlet, providing $HW \leq 1.2D$.

(4) The next step in this design is to determine the actual headwater depth and to confirm the Type I operation.

$$HW = d_c + \frac{V_c^2}{2g} + h_e + h_f - S_o L$$

$$d_c = 3.65'$$

$$\text{For } \frac{d_c}{D} = 0.73; V_c \text{ (Figure 4-15)} = 10.7 \text{ fps}$$

$$\frac{V_c^2}{2g} = \frac{(10.7)^2}{64.4} = 1.77'$$

$$h_e = 0.5 \times 1.77 = 0.89'$$

h_f is calculated as follows:

$$1.1 d_c = 1.1 \times 3.65 = 4.01'$$

$$\frac{1.1 d_c}{D} = \frac{4.01}{5.0} = 0.8$$

To determine the friction slope S_f ,

enter Figure 4-14 with $D = 60''$, $\frac{d_c}{D} = 0.8$

$$Q = 163 \text{ and determine } S_f = 0.0038$$

$$h_f = S_f L = 0.0038 \times 200 = 0.76'$$

$$S_o L = 0.002 \times 200 = 0.40'$$

$$HW = 3.65 + 1.77 + 0.89 + 0.76 - 0.40 = 6.67'$$

- (5) Since $HW > 1.2D$ for the concrete pipe, the concrete pipe will not function as Type I operation. Also the HW exceeds the allowable.
- (6) The designer must now try another pipe size to carry the design flow. Try 2-66" pipes.
- (7) Use Figure 4-13; Connect $Q = 163$ cfs with $D = 66''$ and read $\frac{d_c}{D} = 0.65$.

$$\frac{d_c}{D} = 0.65D = 0.65 \times 5.5 = 3.58'$$

- (8) Use Figure 4-14; Connect 66" with $\frac{d_c}{D} = 0.65$ and intersect turning line. Connect turning line with $Q = 163$ and determine $S_c = 0.004$.

We have now assembled the following data:

Existing Channel	Culvert
$S_o = 0.002$ ft./ft.	$S_c = 0.004$ ft./ft.
$TW = 2.6'$	$d_c = 3.58'$
	$D = 5.5'$

Since $S_o < S_c$ and $TW < d_c$, we have a Type I operation, providing $HW < 1.2D$.

- (9) Check to determine the actual headwater depth and to confirm the Type I operation.

$$HW = d_c + \frac{v_c^2}{2g} + h_e + h_f - S_o L$$

$$d_c = 3.58'$$

$$\text{For } \frac{d_c}{D} = 0.65; \text{ from Figure 4-15, } v_c = 10.0 \text{ fps}$$

$$\frac{v_c^2}{2g} = \frac{(10)^2}{64.4} = 1.55'$$

$$h_e = 0.5 \times 1.55 = 0.78'$$

$$\frac{1.1d_c}{D} = \frac{1.1(3.58)}{5.5} = 0.72$$



From Figure 4-14 with $D = 66''$, $\frac{d}{c} = 0.72$, and $Q = 163$;

determine $S_f = 0.0032$

$$h_f = S_f L = 0.0032 \times 200 = 0.64'$$

$$S_o L = 0.002 \times 200 = 0.40'$$

$$HW = 3.58 + 1.55 + 0.78 + 0.64 - 0.40 = HW = 6.1'$$

(10) Since $HW < 1.2D$, the pipe will function as a Type I operation. Also the headwater is calculated to be less than the allowable.

(11) Check outlet velocity to determine if within allowable.

$$\text{Outlet velocity} = V_c = 10 \text{ fps}$$

This velocity is greater than allowable. The designer must consider providing riprap in the downstream channel or some type of energy dissipation method or try another size pipe culvert.

Example 6:

Given: To illustrate Type III operation assume the same data as in Example 5 except that $S_o = 0.02$ and the allowable outlet velocity is 15 fps due to a solid rock channel.

Solution:

Follow the same procedure as in Example 5 for determining the initial size, critical depth and critical slope which is summarized below:

Existing Channel	Culvert
$S_o = 0.02 \text{ ft./ft.}$	$S_c = 0.0046 \text{ ft./ft. (Conc.)}$
$TW = 2.6'$	$d_c = 3.65'$
	$D = 5.0'$

Since $S_o > S_c$ and $TW < D$, the installation will function as Type III operation providing the entrance is unsubmerged, i.e. $HW < 1.2D$

(1) The next step in this design is to determine the actual headwater depth and to confirm the Type III operation.

$$HW = \frac{HW}{D} \times D$$

$$\frac{HW}{D} \text{ (Figure 4-17} = 1.13 \text{ for concrete pipe.)}$$

$$HW \text{ (Conc. - grooved end with headwall)} = 1.13D = 1.13 \times 5.0 = 5.65'$$

Since $HW < 1.2D$ the concrete pipe will function as Type III operation.

(2) The velocity for Type III operation varies from critical velocity at the entrance to uniform velocity at the outlet providing the installation is sufficiently long and the TW depth = uniform depth.

Enter Figure 4-14 with $S_0 = 0.02$, $Q = 163$,

$D = 60''$ and determine

$$\frac{d}{D} = 0.45, d = 0.45D = 0.45 \times 5.0 = 2.25$$

Since $TW \geq 2.25$ the outlet velocity is based on TW depth as follows:

$$\frac{d_{TW}}{D} = \frac{2.25}{5.0} = 0.45$$

Enter Figure 4-15 with $D = 60''$, $Q = 163$ and the controlling

$\frac{d}{D}$ ratios and determine

V (outlet - Conc.) = 19.0 fps

Some provision must be made to reduce the outlet velocity to the allowable velocity.

CONCRETE PIPE

DIAM. OF PIPE D (INCHES)	CLASS "B" BEDDING				CLASS "C" BEDDING			
	(H) MAXIMUM ALLOWABLE COVER-FEET				(H) MAXIMUM ALLOWABLE COVER-FEET			
	II*	III	IV	V	II	III	IV	V
18	11	13	20	25	9	12	18	22
24	12	14	21	26	10	13	19	23
36	13	16	23	28	11	14	20	24
48	14	16	24	29	11	15	21	25
60	14	17	24	29	12	15	21	26
72	14	17	24	30	12	16	22	26
84	15	17	25	30	13	16	22	27
96	15	18	25	31	13	16	23	27
108	15	18	26	32	13	17	23	28

* ASTM C76-72 Table Designation

CORRUGATED METAL PIPE

3"x1" CORRUGATIONS											
DIAM. OF PIPE D (INCHES)	MIN. COVER ABOVE PIPE (INCHES)	(H) MAXIMUM ALLOWABLE COVER-FEET									
		16 GA. (0.064")		14 GA. (0.079")		12 GA. (0.109")		10 GA. (0.138")		8 GA. (0.168")	
		Round	Elong	Round	Elong	Round	Elong	Round	Elong	Round	Elong
36	12	27	40	31	50	40	74				
42	12	21	34	23	42	29	58				
48	12	17	30	19	37	23	46				
54	12	15	27	16	32	19	38				
60	12	13	24	15	29	16	33				
66	12	13	22	13	27	15	30				
72	12	12	20	12	25	14	27				
78	12	12	18	12	23	13	26				
84	12			12	21	12	24	13	26		
90	12				12	24	12	35	13	26	
96	12				11	23	12	24	12	25	
102	24						12	23	12	24	
108	24								12	23	
114	24								11	23	
120	24								11	20	

2 3/4"x1/2" CORRUGATIONS													
DIAM. OF PIPE D (INCHES)	MIN. COVER ABOVE PIPE (INCHES)	(H) MAXIMUM ALLOWABLE COVER-FEET											
		16 GA. (0.064")		14 GA. (0.079")		12 GA. (0.109")		10 GA. (0.138")		8 GA. (0.168")			
		Round	Elong	Round	Elong	Round	Elong	Round	Elong	Round	Elong		
12	12	70		76									
15	12	56		61									
18	12	40		48		64							
24	12	23		26		33							
30	12			18	30	22	43	25	51				
36	12			15	25	17	33	19	38				
42	12					14	28	16	31	17	34		
48	12					13	25	14	27	15	29		
54	12					12	24	13	25	13	26		
60	12							12	23	12	25		
66	12								11	22	12	23	
72	12								11	17	11	21	
78	12										11	17	
84	12										11	13	

CORRUGATED METAL PIPE ARCH

2 3/4"x1/2" CORRUGATIONS									
SPAN (INCHES)	RISE (INCHES)	RC (INCHES)	MIN. COVER ABOVE PIPE (INCHES)	(H) MAXIMUM ALLOWABLE COVER-FT.					
				16 GA. (0.064")	14 GA. (0.079")	12 GA. (0.109")	10 GA. (0.138")	8 GA. (0.168")	
18	11	3.5	18	6	6				
22	13	4	18	6	6				
25	16	4	18	5	5				
29	18	4.5	18	5	5				
36	22	5	18	5	5				
43	27	5.5	18	4	4				
50	31	6	18			4	4	4	
58	36	7	18			4	4	4	
65	40	8	18			4	4	4	
72	44	9	18				4	4	
79	49	10	18					4	
85	54	11	18						4

3"x1" CORRUGATIONS									
SPAN (INCHES)	RISE (INCHES)	RC (INCHES)	MIN. COVER ABOVE PIPE (INCHES)	(H) MAXIMUM ALLOWABLE COVER-FT.					
				16 GA. (0.064")	14 GA. (0.079")	12 GA. (0.109")	10 GA. (0.138")		
43	27	7.75	18	6	6				
50	31	9	18	6	6				
58	36	10.5	18	6	6				
65	40	12	18	6	6				
72	44	13.25	18	6	6				
73	55	18	18	8	8				
81	59	18	18		7				
87	63	18	18		7	7			
95	67	18	18		6	6			
103	71	18	24			6			
112	75	18	24				5		
117	79	18	24					5	
128	83	18	24						5

NOTE:
 1 Where a pipe size not listed in the table is required, the H indicated for the next smaller size shown shall apply

DEPTH OF COVER TABLES



PIPE BEDDINGS

TRENCH BEDDINGS

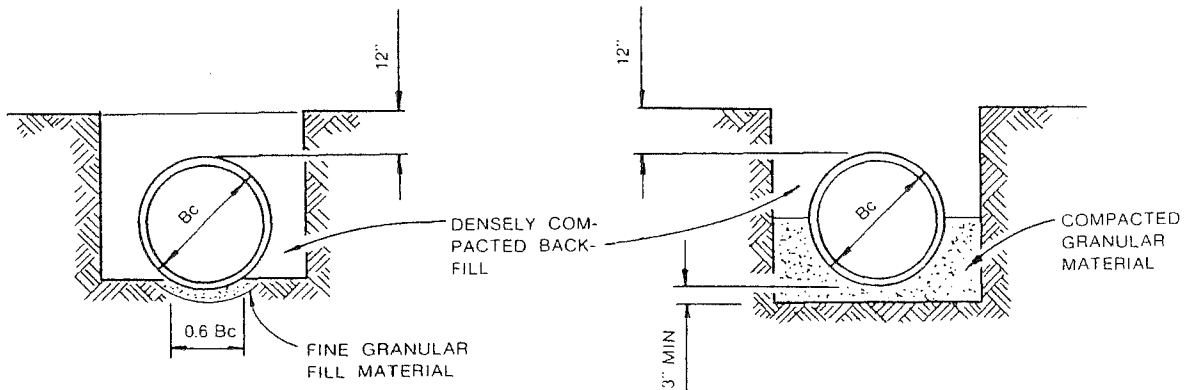

SHAPED SUBGRADE

GRANULAR FOUNDATION

CLASS B

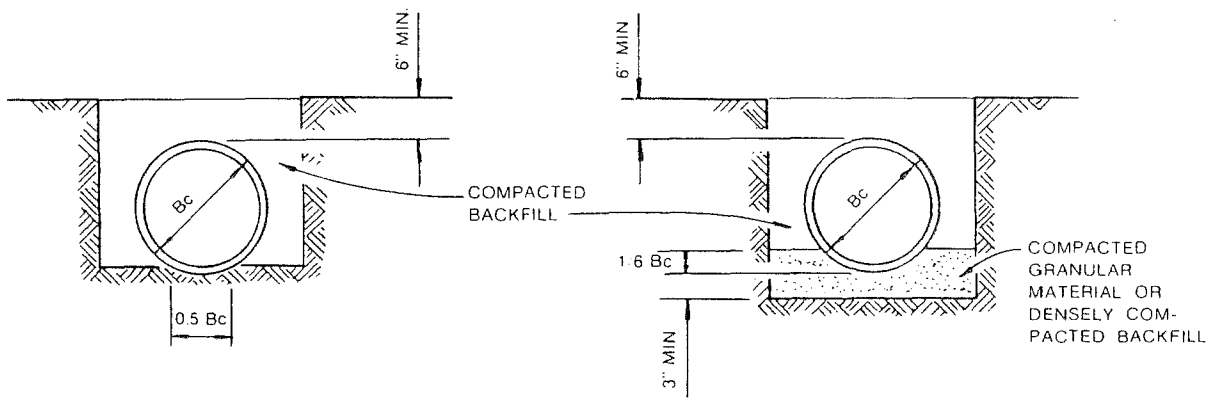

SHAPED SUBGRADE

GRANULAR FOUNDATION

CLASS C

PIPE BEDDINGS

EMBANKMENT BEDDINGS

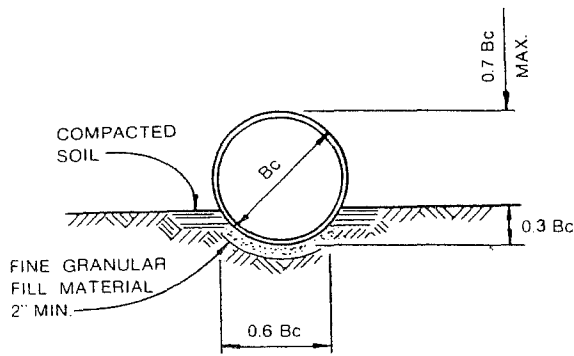

SHAPED SUBGRADE AT GRANULAR FOUNDATION

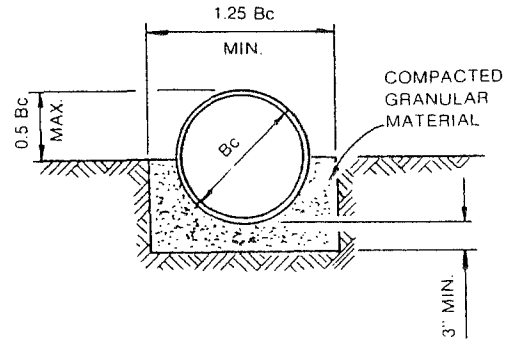

GRANULAR FOUNDATION

CLASS B

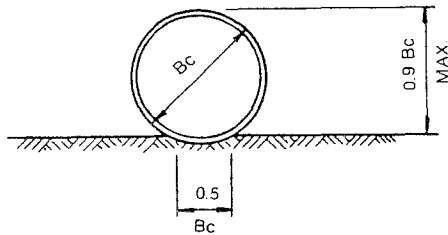

SHAPED SUBGRADE

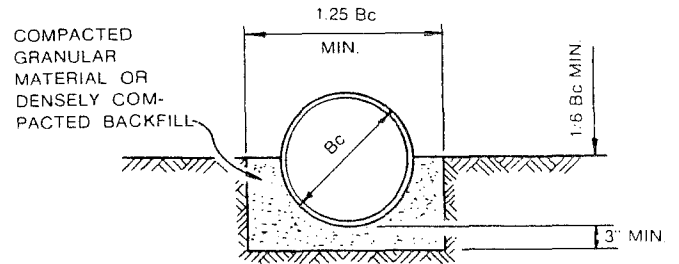

GRANULAR FOUNDATION

CLASS C

NOTE: FOR ROCK AND OTHER INCOMPRESSIBLE MATERIALS THE TRENCH SHOULD BE OVEREXCAVATED A MIN. OF 6" REFILL WITH GRANULAR MATERIAL.

SECTION V. - STORMWATER DETENTION

- 5.1 General
- 5.2 Method of Evaluation
- 5.3 Differential Runoff Rates
- 5.4 Volume of Detention
- 5.5 Simplified Volume Formula
- 5.6 Graphic Representation
- 5.7 Modified Rational Hydrograph Method
- 5.8 Methods of Detention
 - 5.8.1 General Location
 - 5.8.2 Dry Reservoirs
 - 5.8.3 Open Channels
 - 5.8.4 Permanent Lakes
 - 5.8.5 Parking Lots
 - 5.8.6 Other Methods
 - 5.8.7 Verification of Adequacy
 - 5.8.8 Control Structures
 - 5.8.9 Discharge Systems
 - ~~5.8.10 Detention~~
 - ~~5.8.11 Intake~~
- 5.9 Example: Detention Calculation

SECTION V - STORMWATER DETENTION

5.1 GENERAL

If hydrologic and hydraulic studies reveal that the proposed development would cause increased flood stages so as to increase the flood damages to existing developments or property, or increase flood elevations beyond the vertical limits set for the floodplain districts, then the development permit shall be denied unless one or more of the following mitigations measured are used: (1) on-site storage, (2) off-site storage, (3) improve the drainage system.

Stormwater runoff and the velocity of discharge are considerably increased through development and growth of the City. Prior to the development of land, surface conditions provide a high percentage of permeability and longer time of concentration. With the construction of buildings, parking lots, etc., permeability and the time of concentration are significantly decreased. These modifications may create harmful effects on properties downstream.

Criteria for differential runoff and detention guidelines are set out below to attempt to decrease the possible effects of development on downstream properties due to increased runoff.

5.2 METHOD OF EVALUATION

Differential runoff evaluation consists of determination of rates of runoff before and after development, determination of required volume of detention and verification of adequacy of discharge and control structures.

5.3 DIFFERENTIAL RUNOFF RATES

Differential runoff rates shall be evaluated by the rational formula. The zero year (frequency) runoff coefficients shall be used. Differential runoff rates shall be evaluated by equation:

$$R = (R_d - R_u) \quad \text{[Equation 1]}$$

Where R = differential runoff rate
 R_d = C.I. factor for developed conditions
 R_u = C.I. factor for undeveloped conditions

Determine "C" value from Tables 2.1 and 2.2.

Use Figure 2-2 to find time of concentration (T_c) then use Figures 2-4 to determine intensity (I).

5.4 VOLUME OF DETENTION

Volumes of detention shall be evaluated according to the following methods:

- A. Volume of detention for projects of less than 50 acres shall be evaluated by the "simplified volume formula."
- B. Volume of detention for projects 50 acres or greater but less than 200 acres may be evaluated either by the "simplified volume formula" or the "modified rational hydrograph method."
- C. For projects larger than 200 acres, the owner's engineer shall submit his proposed method of evaluation for the sizing of the retention basin or detention basin to the Department of Public Works. The method will be evaluated for a professional acceptance, applicability and reliability by the City Engineer. No detail review for projects larger than 200 acres will be rendered before the method of evaluation of the retention or detention basin is approved.
- D. Other analytical methods of evaluation of volume of detention require approval by the City Engineer.

5.5 SIMPLIFIED VOLUME FORMULA

Total volume of detention shall be computed by the equation:

$$V = R \times A \times T_c \text{ (minutes)} \times 60 \text{ (sec./min.)}$$

V = Total volume of retention

R = Differential runoff rate

A = Area of the project and the acres

T_c = Time of concentration from Figure 2-2 as determined for use with differential runoff rates

5.6 GRAPHIC REPRESENTATIVE

For purpose of further analysis, the simplified volume formula may be represented by a triangular synthetic hydrograph as shown in Figure 5-1 with the following elements:

T_d = base time of hydrograph for developed project without retention

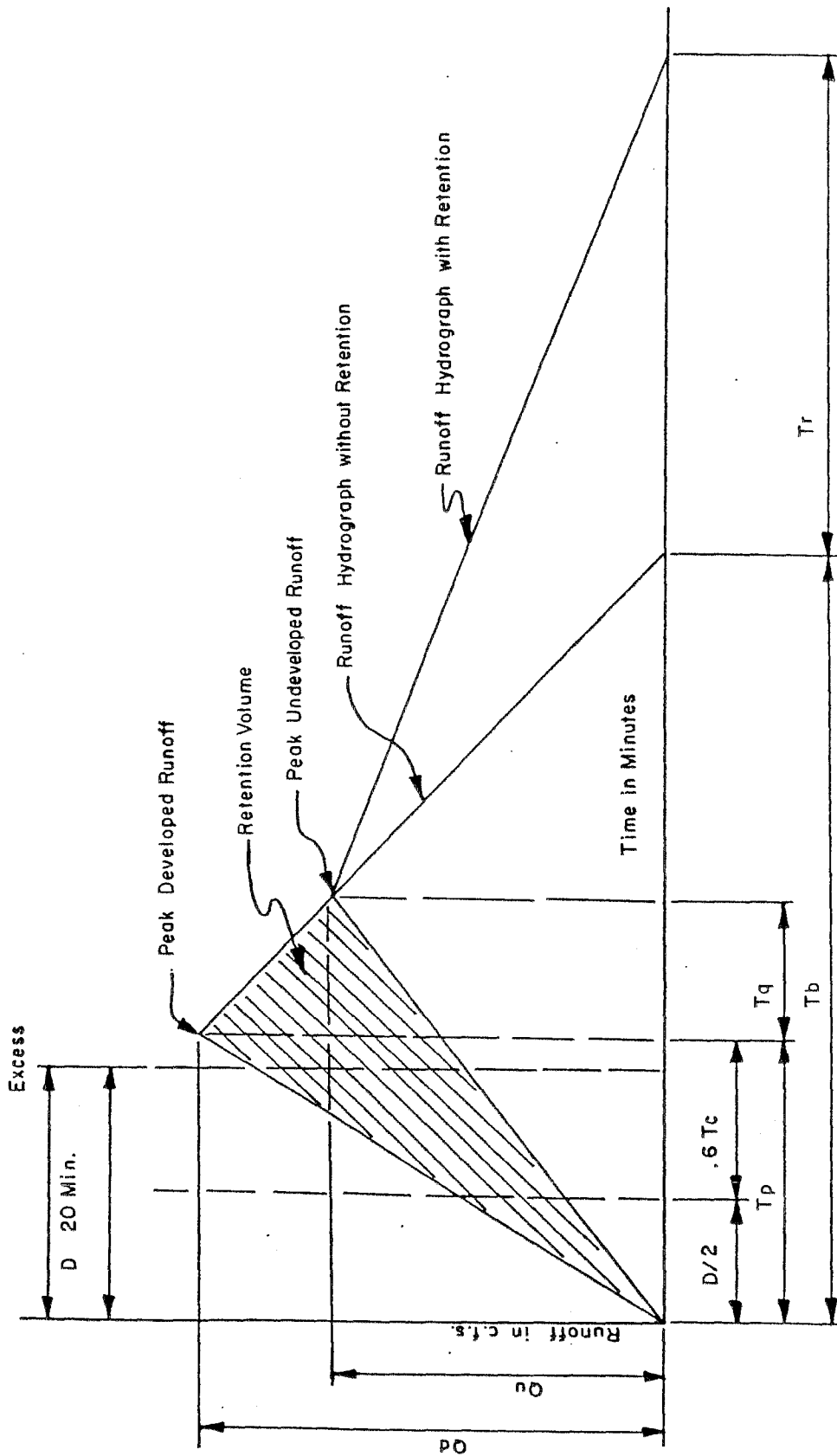

$T_d = 60$ minutes

$T_p =$ Time of peak runoff for developed project

$T_p = 20$ minutes

$Q_d =$ total peak runoff for developed project in CFS

$Q_d = A \times RD$ (see Equation 1)

$Q_u =$ total peak runoff of unimproved project in CFS

$Q_u = A \times RU$ (see Equation 1)

$A =$ total area of project in acres

$T_q =$ assumed time of peak differential for unimproved project

$T_q = (1 - Q_u/Q_d) 40$

$T_r =$ Assumed precedent recedence time differential for discharge at rates no greater tna unimproved condition

$T_r = (60 Q_d/Q_u) - 60$

$V =$ Volume of detention

$V = (Q_d - Q_u) \times 30$ (min.) $\times 60$ (sec./min.)

5.7 MODIFIED RATIONAL HYDROGRAPH METHOD

This is a modification of the Unit Hydrograph Method of hydrologic evaluation simplified to reflect features of present practice and some elements of topographic characteristics, concentration patterns, and routing. Figure 5-1 illustrated the elements of the modified hydrograph. Steps to develop the hydrograph are as follows:

- (1) Determine the time of concentration for the project by the use of Figure 2-2 or Figure 4-17.

For analysis of large improved channels, time of travel for overland flow and channel are to be analyzed to determine reasonable (T_C) time of concentration.

- (2) Determine time of peaking by equation:

$$T_p = D/2 + .6 T_c$$

Where T_c = time of peak discharge of developed project in minutes

$$D = 20 \text{ min.} = \text{storm duration in minutes}$$

- (3) Determine the base time of the hydrograph without detention, by equation.

$$T_b = 2.67 T_p$$

- (4) Determine the base time of the hydrograph with detention by equation.

$$T_r = T_b ((Q_d/Q_u) - 1)$$

Where T_r = Additional time required for discharged at a rate no greater than that of the undeveloped condition.

Q_d = total peak runoff of the improved project in CFS

$$Q_d = A \times R_D \text{ (see Equation 1)}$$

Q_u = total runoff of unimproved project in CFS

$$Q_u = A \times R_u \text{ (see Equation 1)}$$

- (5) Determine the required volume of detention by equation:

$$V = 1/2 (Q_d - Q_u) T_b \times 60$$

5.8 METHOD OF DETENTION

The following conditions and limitation shall be observed in selection and use of method of detention:

5.8.1 GENERAL LOCATION

Detention facilities shall be located within the parcel limits of the project under consideration. No detention or ponding will be permitted within public road right-of-ways. Location of detention facilities immediately upstream or downstream of the project will be considered by special request if proper documentation is submitted with reference to practicality, feasibility, and proof of ownership or right-of-use of the area proposed. Conditions for general location of detention facilities are identified in the following sections.

5.8.2 DRY RESERVOIRS

Wet weather ponds or dry reservoirs shall be designed with proper safety, stability, and ease of maintenance facilities, and shall not exceed four (4) feet in depth. Maximum side slopes for grass reservoirs shall not exceed one (1) foot vertical for three (3) feet horizontal (3:1) unless adequate measures are included to provide for the above noted features. In no case shall the limits of maximum ponding elevation be closer than thirty (30) feet horizontally from any building and less than one (1) foot vertically below the lowest sill or floor elevation. The entire reservoir area shall be seeded, fertilized, mulched, sodded or paved as required prior to final plat approval or issuance of certificate of occupancy. Any area susceptible to, or designed as, overflow by higher design intensity rainfall (25-year frequency) shall be sodded or paved depending upon the outflow velocity.

5.8.3 OPEN CHANNELS

Normally permitted open channels may be used as detention areas provided that the limits of the maximum ponding elevation are not closer than thirty (30) feet horizontally from any buildings, and less than one (1) foot below the lowest sill or floor elevation of any building. No ponding will be permitted within public road rights-of-way unless approval is given by the City Engineer. Maximum depth of retention and open channels shall be four (4) feet. Minimum flow line grade shall be 0.5 percent for grass or untreated bottoms or 0.2 percent for paved channels.

For trapezoidal sections, the maximum side slopes of the detention of the channel shall not exceed one (1) foot vertical for three (3) feet horizontal (3:1). For design of other typical channel sections, the features of safety, stability, and ease of maintenance shall be observed by the design engineer.

The entire reservoir area of the open channel shall be seeded, fertilized, mulched, sodded or paved as required in the original design. The hydraulic or water surface elevations resulting from channel detention shall not adversely effect adjoining properties.

5.8.4 PERMANENT LAKES

Permanent lakes with fluctuating volume controls may be used as retention areas provided that the limits of maximum ponding elevations are no closer than thirty (30) feet horizontal from any building and less than one (1) foot below the lowest sill or floor elevation of any building.

Maximum side slopes for the fluctuating area of permanent lakes shall be one (1) foot vertical to three (3) feet horizontal (3:1) unless provisions are included for safety, stability, and ease of maintenance.

Suggested maximum fluctuation from permanent pool elevations to maximum ponding elevations shall be three (3) feet. Each design has its own particular parameters in relation to the adjoining topography.

Special consideration is suggested to safety and accessibility to small children in design of permanent lakes in residential areas. It is suggested that the minimum of twenty-five percent (25%) of the permanent pool area be no less than 10 feet. Allowances for silting under denuded soil conditions (during construction) for a period no less than one year is also recommended.

The entire fluctuating area of the permanent reservoir shall be seeded, fertilized and mulched, sodded or paved. Any area susceptible to or designed as overflow by higher design intensity rainfall (100-year frequency) shall be sodded or paved, depending on the design velocities. An analysis shall be furnished of any proposed earthen dam construction soil. A boring of the foundation for the earthen dam may be requested by the City Engineer. Earthen dam structures shall be designed by a Professional Engineer.

5.8.5 PARKING LOTS

Detention is permitted in parking lots to maximum depths of 9 inches. In no case should the maximum limits or ponding be designed closer than ten (10) feet from a building unless waterproofing of the building and pedestrian accessibility are properly documented and approved.

The minimum freeboard and the maximum ponding elevation to the lowest sill or floor elevation shall be one (1) foot.

5.8.6 OTHER METHODS

Other methods of detention such as seepage pits, French drains, etc., are discouraged. If other methods are proposed, proper documentation of soil data, percolation, geological features, etc., will be needed for review and consideration.

5.8.7 VERIFICATION OF ADEQUACY

Analysis of all elements of design is always performed by the engineer of record. The following outline is provided to ascertain that certain critical elements of design are in workable compliance to the aims of design. For projects less than five acres in area, there is no need for submittal of routing calculations for tabulated proof of adequacy for

tributary runoff or detention; however, it is recommended that verification be made of: (a) volume of detention for the total project, (b) tributary (Q) peak runoff to the basin, (c) balance maximum outflow rate from the low-flow structure, (d) ratios of in flow to out flow rates, (e) sizing of the overflow facilities, (f) stability of detention dikes or dams, (g) safety features, (h) maintenance features.

For projects of five acres or greater, but less than 200, routing calculations shall be submitted in legible tabulated form. Proof of adequacy of volume of detention and sizing computations for low-flow structure shall also be submitted. Features of stability and safety may also need to be documented if the scope of the project requires special attention in this area of design.

Projects over 200 acres in area shall provide documented verification of adequacy according to scope and complexity of design.

5.8.8 CONTROL STRUCTURES

Detention facilities shall be provided with obvious and effective control structures. Plan view and sections of the structure with adequate details shall be included in plans.

The design discharge (Q) for the low-flow pipe shall not exceed the existing 25-year runoff from the tributary area. Suggested discharge for the low-flow pipe is the existing 10-year runoff (Q).

The maximum discharge shall be designed to take place under total anticipated design-head conditions.

Sizing of the low-flow pipe shall be by inlet control or hydrologic control or hydrologic gradient requirements. Figures 4-17 "Headwater Depth for Concrete Pipe Culverts with Inlet Control" provides headwater vs. discharge relationships for all pipe sizes permitted. This chart is a reproduction of Chart 2 of Hydrologic Engineering Circular #5, Federal Highway Administration, which is based on the research for the National Bureau of Standards by J.C. French, and experimental research data obtained by H. Bossy working for the ASCE.

Low-flow pipes shall not be smaller than eight (8) inches in diameter to minimize maintenance and operating problems except in parking lot and roof retention where minimum size of openings shall be designed specifically for each condition. A bar-screen on a minimum 2:1 slope to reduce blockage by debris is suggested on the flow-pipe.

The overflow opening or spillway shall be designed to accept the total peak runoff to the improved tributary area.

5.8.9 DISCHARGE SYSTEMS

Sizing of the system below the control structure shall be for the total improved peak runoff tributary to the structure with no allowance for detention.

~~XXXXXX EASEMENTS XX~~

~~Two types of easements shall be provided in plans for detention facilities.~~

~~(a) Maintenance Easement XX~~

~~All detention reservoirs with the exception of parking lot and roof detention shall be enclosed by a maintenance easement for public use. The limits of the easement shall extend ten (10) feet beyond the maximum anticipated flooding area.~~

~~(b) Drainage Easement XX~~

~~A minimum ten (10) foot wide drainage easement shall be provided within the reservoir area connecting the tributary pipes and the discharge system along the most passable routing of piping system for possible future elimination of detention.~~

~~5.8.11 MAINTENANCE~~ 5.8.10 MAINTENANCE

Detention facilities, when mandatory, are to be built in conjunction with storm sewer installation and/or grading. Since these facilities are intended to control increased runoff, they must be partially or fully operational soon after the clearing of the vegetation. Silt and debris connected with early construction shall be removed periodically from the detention area and control structure in order to maintain a close to full storage capacity.

~~Maintenance of detention facilities is divided into two components. The first is long-term maintenance which involves removal of sediment from the basin and outlet control structure. Maintenance to an outlet structure is minimal due to the initial design of permanent concrete or pipe structures. Studies indicate that in developing areas, basin cleaning by front-end loader or gradall is estimated to be needed once every 5 to 10 years. The city is responsible for long-term maintenance.~~

~~Short term~~ Maintenance ~~XXXXXX~~ is the ~~XXXXXX~~ component and is the responsibility of the property owner or association. The items considered ~~XXXXXX~~ maintenance are as follows:

1. Minor dirt and mud removal
2. Outlet cleaning
3. Mowing
4. Herbicide spraying
5. Litter control
6. Tree Removal

The responsibility of all maintenance of the detention facilities and subdivision projects shall remain with the developer until the project has been approved for final platting. Upon final plat approval, ~~the short term~~ maintenance responsibility shall be vested in the trustees of the subdivision, by virtue of the trust indenture. The indenture of trusts shall clearly indicate resident responsibility for maintenance in cases of projects without common ground.

The responsibility of maintenance of the retention facilities and single lot development projects shall remain with the general contractor until final inspection of the development is performed and approved, and a legal occupancy permit is issued. After legal occupancy of the project, the maintenance of detention facilities shall be bested with the owner of the project.

If the trustees or owner fail to provide reasonable degree of maintenance and the facilities become inoperable or ineffective, as determined by the Little Rock City Engineer, the Little Rock Public Works Department shall perform remedial work and assess the trustees or owner for the cost of repair and maintenance.

5.9 EXAMPLE CALCULATION

1.00 Acre Lot

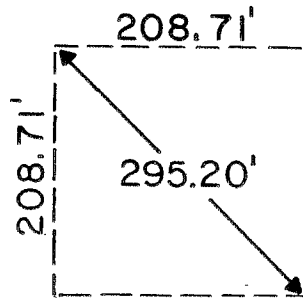

$$C_u = .10$$

$$C_d = 1.0$$

$$t_c = < 5 \text{ min.} \quad L = 295.20$$

$$I_{25} = 8.5 \quad I_5 = 6.8$$

$$s = 0.10 / \text{ft.} = 10 \%$$

$$n = 0.013 \text{ (concrete)}$$

DESIGN DISCHARGE:

$$Q_5 = C_u I_5 A = (0.1) (6.8) (1) = .68$$

From Manning Formula Nomograph; outlet pipe will be 4". However, minimum pipe size allowed is 8". Therefore use 8".

DIFFERENTIAL RUNOFF RATE:

$$R = C_d I_{25} - C_u I_{25} = (1.0) (8.5) - (0.1) (8.5) = 7.65$$

TOTAL VOLUME OF DETENTION:

$$V = R \cdot A \cdot t_c \cdot 60 = (7.65) (1) (5) 60 = 2,295 \text{ cu. ft.}$$

General Notes:

1. Minimum t_c shall be 5 minutes.
2. Volume of detention shall be that computed amount between the 25-year developed and 25-year undeveloped conditions.
3. Discharge structure shall be designed for not greater than a 10-year design storm with minimum size outlet not less than a 8" diameter pipe.
4. All outlet structures shall be concrete.
5. Temporary detention during construction shall be provided.

Revised from Springfield, Missouri design charts

INTENSITY - DURATION - FREQUENCY

LITTLE ROCK

SOURCE: HYDRO 35 & T.P. No. 40

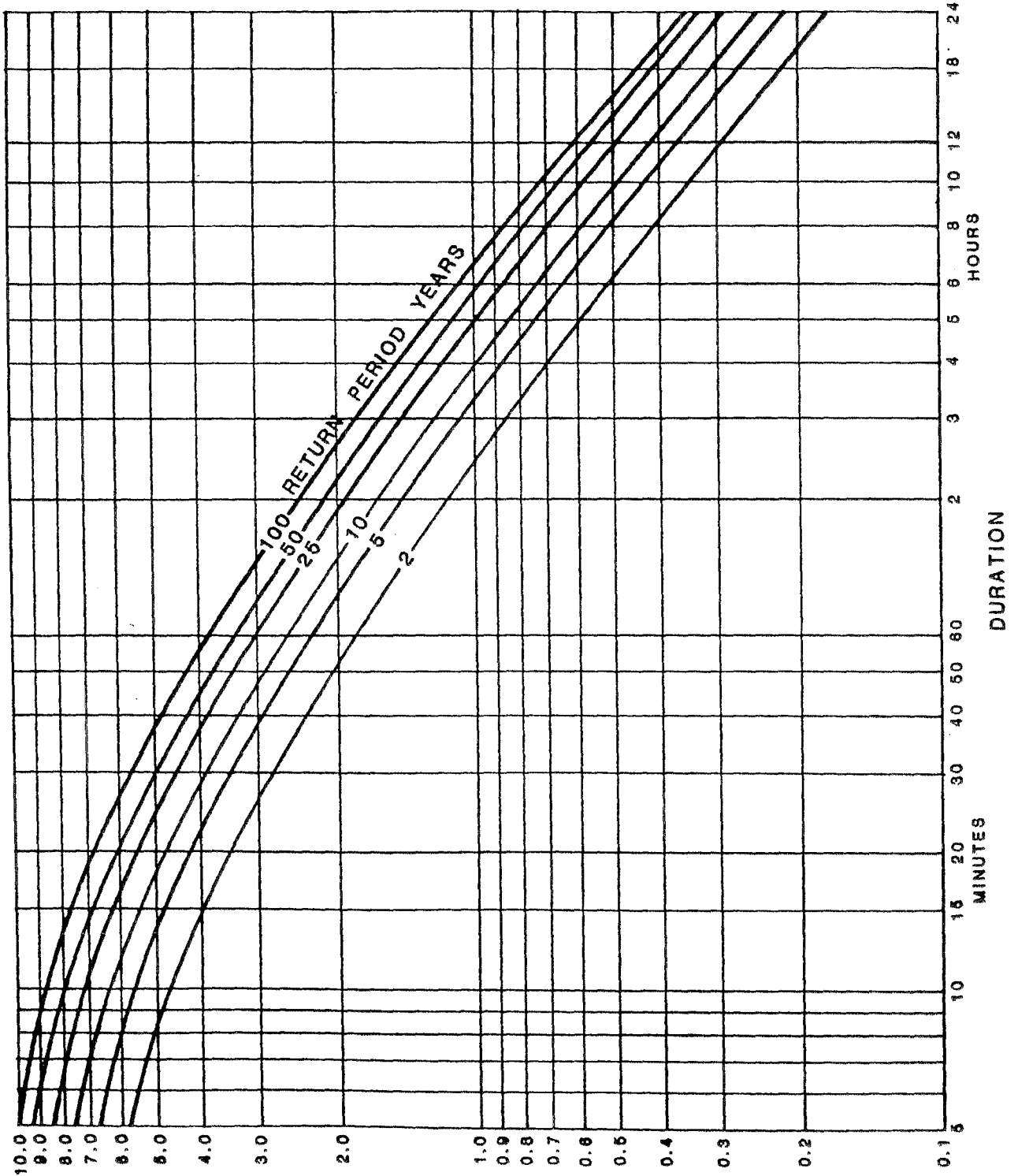

RAINFALL INTENSITY IN INCHES PER HOUR

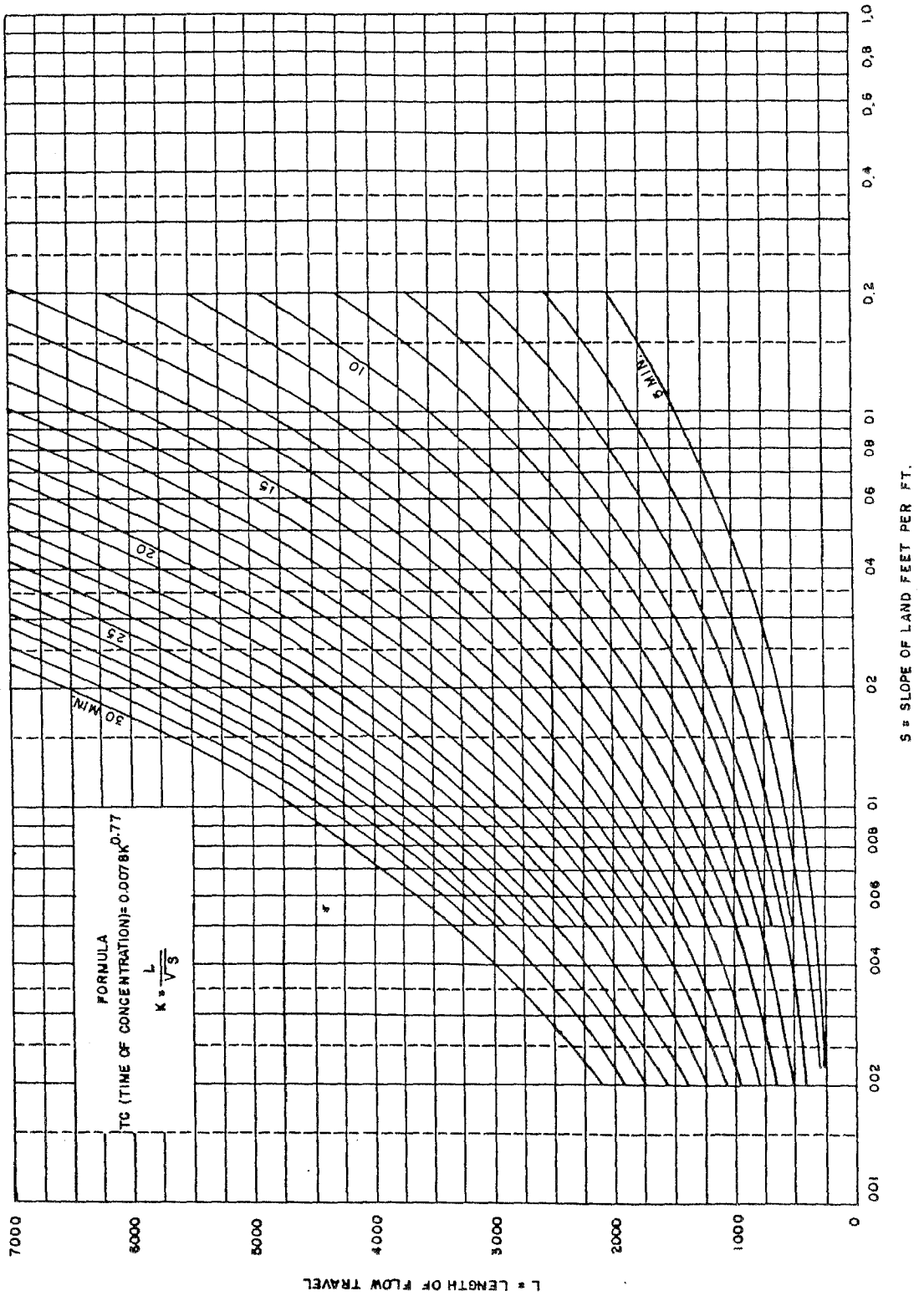
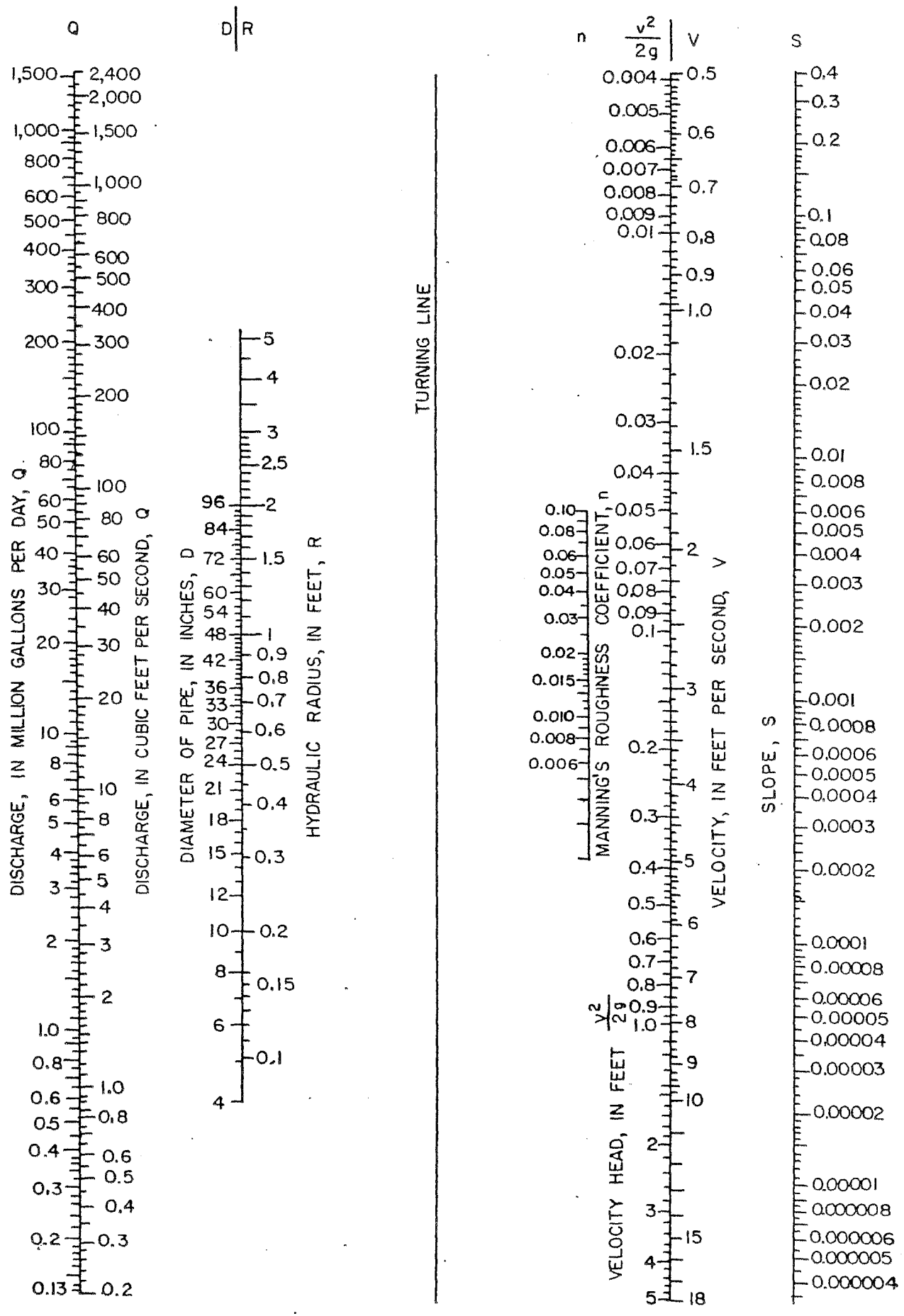
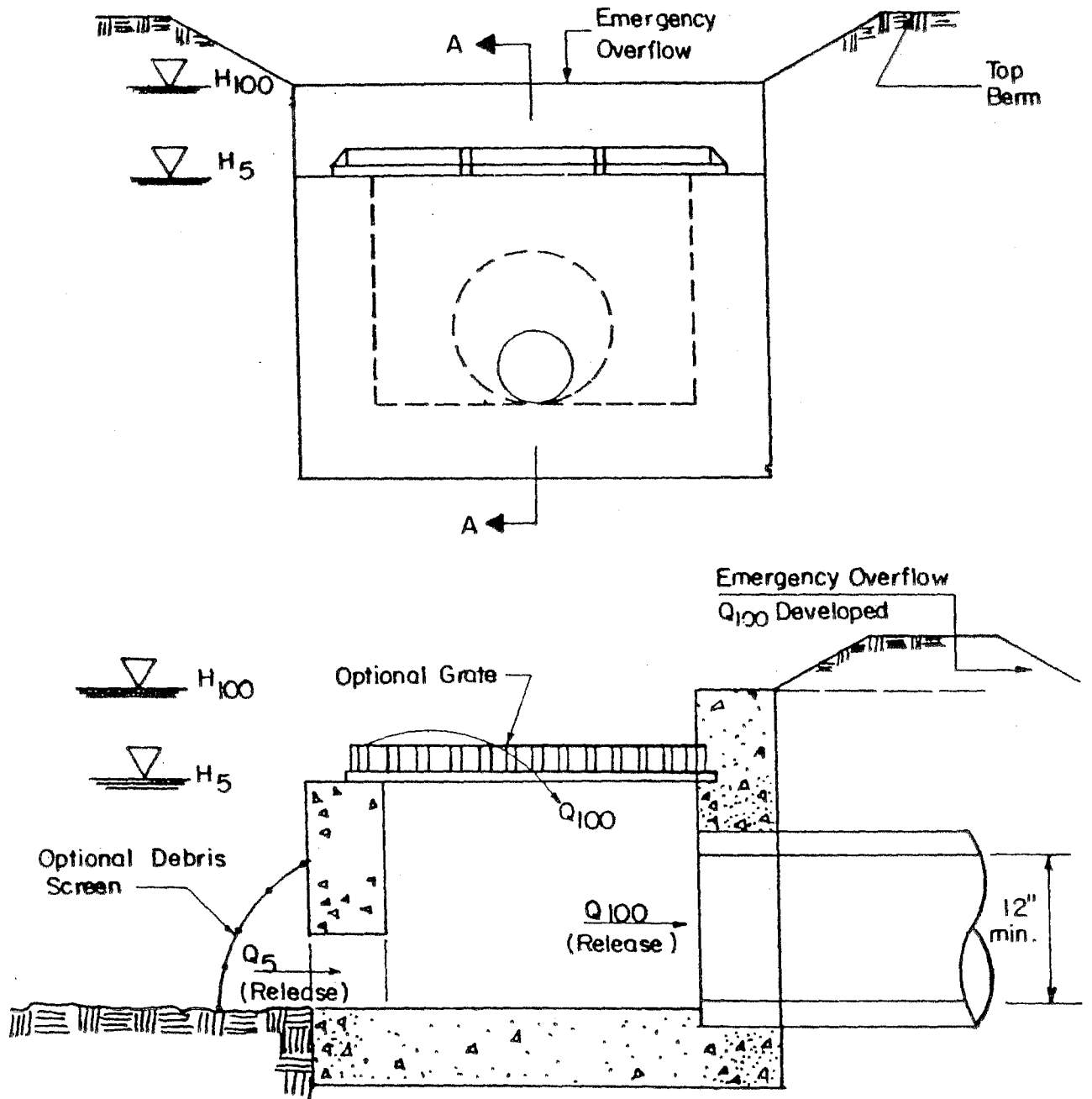

CHART FOR DETERMINING FLOW TIME



Nomograph for solution of the Manning formula.



Section A-A

Source: City of Lakewood Colorado

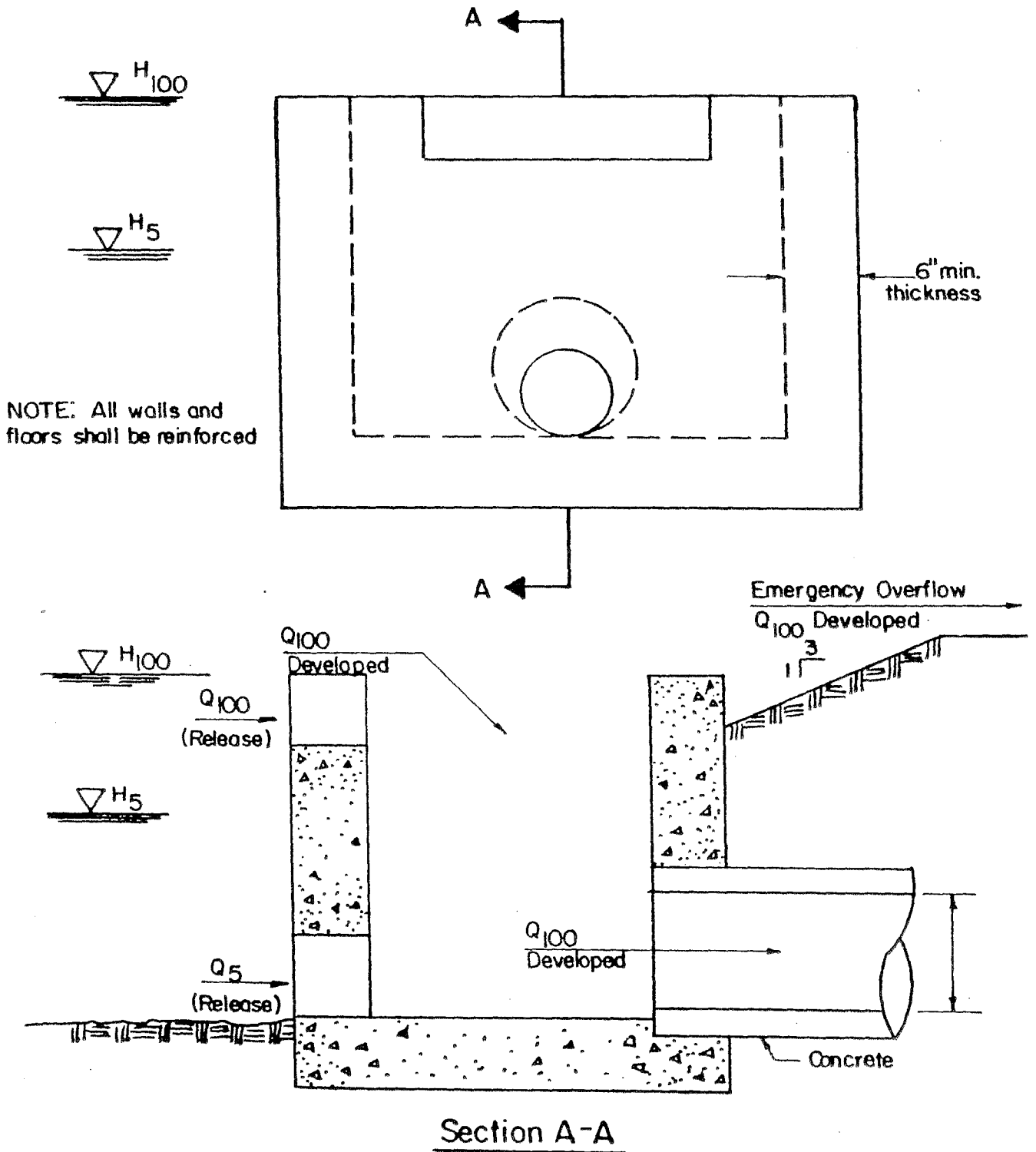

Source: City of Lakewood, Colorado

 CITY OF LITTLE ROCK	Title DETENTION BASIN DESIGN	No.	Page 1 of 11
		Issue Date 4/8/85	Revision Date
DEPARTMENT OF PUBLIC WORKS		Approved By M. Botie	

GIVEN: A 20 Acre parking lot drains to one side. A possible detention pond site is available on this side. Approximate dimensions available of 150' x 300'. The parking area is approximately square.

REQUIRED: A detention facility that will control the peak outflow from the 25 year storm to the peak outflow of the existing condition 25 year storm.

SOLUTION:

(1) Inflow hydrograph: 25 year storm

$$Q = CIA \quad C = .91 \text{ for parking lot (Table 2.2)}$$

Estimate t_c :

$$A \text{ 20 acre square } \approx 933' \times 933'$$

$$\therefore \text{diagonal} \approx 1319'$$

Assume a slope of 2%

$$\therefore t_c = 10 \text{ minutes (Figure 2-2)}$$

$$I = 7.2 \text{ in/hr (Figure 2-4)}$$

$$A = 20 \text{ Acres}$$

$$Q = (.91)(7.2)(20) = 131 \text{ cfs}$$

\therefore Coordinates of Peak:

$$Q_p = 131 \text{ cfs}$$

$$t_p = 10 \text{ minutes}$$

(2) Preliminary Basin Design:

(A) Allowable outflow Peak:

$$Q_o = CIA \quad \left\{ \begin{array}{l} \text{Existing Site Conditions; Clay Soil} \\ \text{See Table 2.2, } C = .33; \text{ Slope @ 2\%} \end{array} \right\}$$

$$Q_o = (.33)(7.2)(20)$$

$$= 47.5 \text{ cfs, use } 48 \text{ cfs}$$

 CITY OF LITTLE ROCK	Title DETENTION BASIN DESIGN	No.	Page 2 of 11
		Issue Date 4/8/85	Revision Date
DEPARTMENT OF PUBLIC WORKS		Approved By M. Batie	

(B) Storage Required:

$$\begin{aligned}
 S &= \frac{1}{2}(Q_i - Q_o) T_b \times 60 \quad (\text{Page 5-5}) \\
 &= \frac{1}{2}(131 - 48)(2.67(10)) \times 60 \\
 &= \frac{1}{2}(83)(26.7)(60) = 66,483 \text{ ft}^3 = 1.53 \text{ AC-FT}
 \end{aligned}$$

Always provide freeboard, \therefore Use 1.70 AC-FT

Assume: (1) Pond Depth = 3' max with 1' freeboard
 (2) Rectangular pond cross-section

$$\text{Area Required} = \frac{1.70 \text{ AC-FT}}{3 \text{ FT}} = .57 \text{ AC} = 24,684 \text{ ft}^2$$

Try a rectangle 100' x 250'

(c) Outlet Structure:

Install a round concrete pipe.

$$Q_o = 48 \text{ cfs when head at 3 ft.}$$

Use Figure 4-17 for headwater depth for concrete pipe culverts with inlet control.

$$\text{Try } 24" \phi \quad \frac{HW}{D} = \frac{3}{2} = 1.5$$

from chart $Q \approx 20 \text{ cfs} \therefore \text{N.G.}$

$$\text{Try } 48" \phi \quad \frac{HW}{D} = \frac{3}{4} = .75$$

from Chart $Q \approx 48 \text{ cfs}$, However pipe too tall; min. cover; $\therefore \text{N.G.}$

$$\text{Try } 2-30" \phi \quad \frac{HW}{D} = \frac{3}{2.5} = 1.2$$

from Chart $Q \approx 28 \text{ cfs} \times 2 = 56 \text{ cfs}$

\therefore Use 2-30" ϕ C.P.

 CITY OF LITTLE ROCK	Title DETENTION BASIN DESIGN	No.	Page 3 of 11
		Issue Date 4/8/85	Revision Date
DEPARTMENT OF PUBLIC WORKS		Approved By M. Batie	

(D) Routing:

(1) Stage - Storage Curve

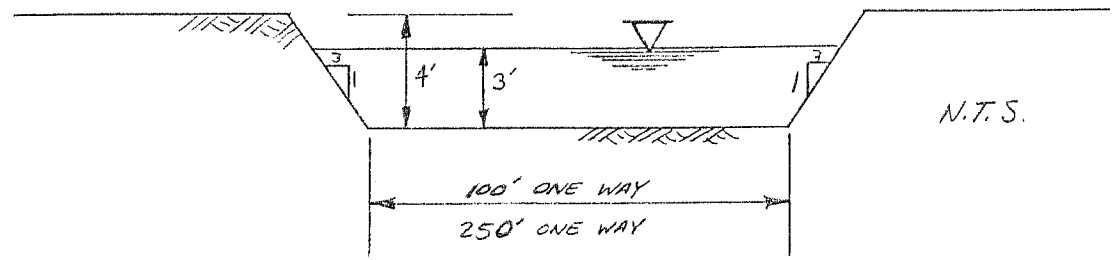

TABLE 1. STAGE-STORAGE

WATER LEVEL (FT)	SURFACE AREA (SQ. FT.)	INCREMENTAL VOLUME (CU. FT.)	ACCUMULATED VOLUME (CU. FT.)
0	100 x 250 = 25,000		0
1	106 x 256 = 27,136	26,068	26,068
2	112 x 262 = 29,344	28,240	54,308
3	118 x 268 = 31,624	30,484	84,792
4	124 x 274 = 33,976	32,800	117,592

(2) Stage - Discharge Curve

For 2-30" ϕ C.P. (From Fig. 4-17 - Circular Concrete Pipe - Ent. Type 1.)

TABLE 2. STAGE-DISCHARGE

WATER LEVEL (FT)	$\frac{HW}{D}$ (D=2.5')	Q_0 1 Pipe (CFS)	Q_0 2 Pipes (CFS)
0	0	0	0
1	.4	≈ 5	≈ 10
2	.8	16	32
3	1.2	28	56
4	1.6	37	74

 CITY OF LITTLE ROCK	Title <i>DETENTION BASIN DESIGN</i>	No.	Page 4 of 11
		Issue Date <i>4/8/85</i>	Revision Date
DEPARTMENT OF PUBLIC WORKS		Approved By <i>M. Batie</i>	

(3) INFLOW HYDROGRAPH

Use dimensionless Hydrograph Coordinates

t/t_p	Q/Q_p
.5	.4
1.0	1.0
1.5	.6
2.0	.3
3.0	.07

$t_p = 10$ minutes } From page 1
 $Q_i = 131$ cfs

DIMENSIONLESS HYDROGRAPH COOR.		t	Q
t/t_p	Q/Q_p		
.5	.4	5	52.4
1.0	1.0	10	131
1.5	.6	15	78.6
2.0	.3	20	39.3
3.0	.07	30	9



CITY OF
LITTLE ROCK

Title

DETENTION BASIN
DESIGN

No.

Page 5 of 11

Issue Date

4/8/85

Revision Date

DEPARTMENT OF
PUBLIC WORKS

Approved By M. Batie

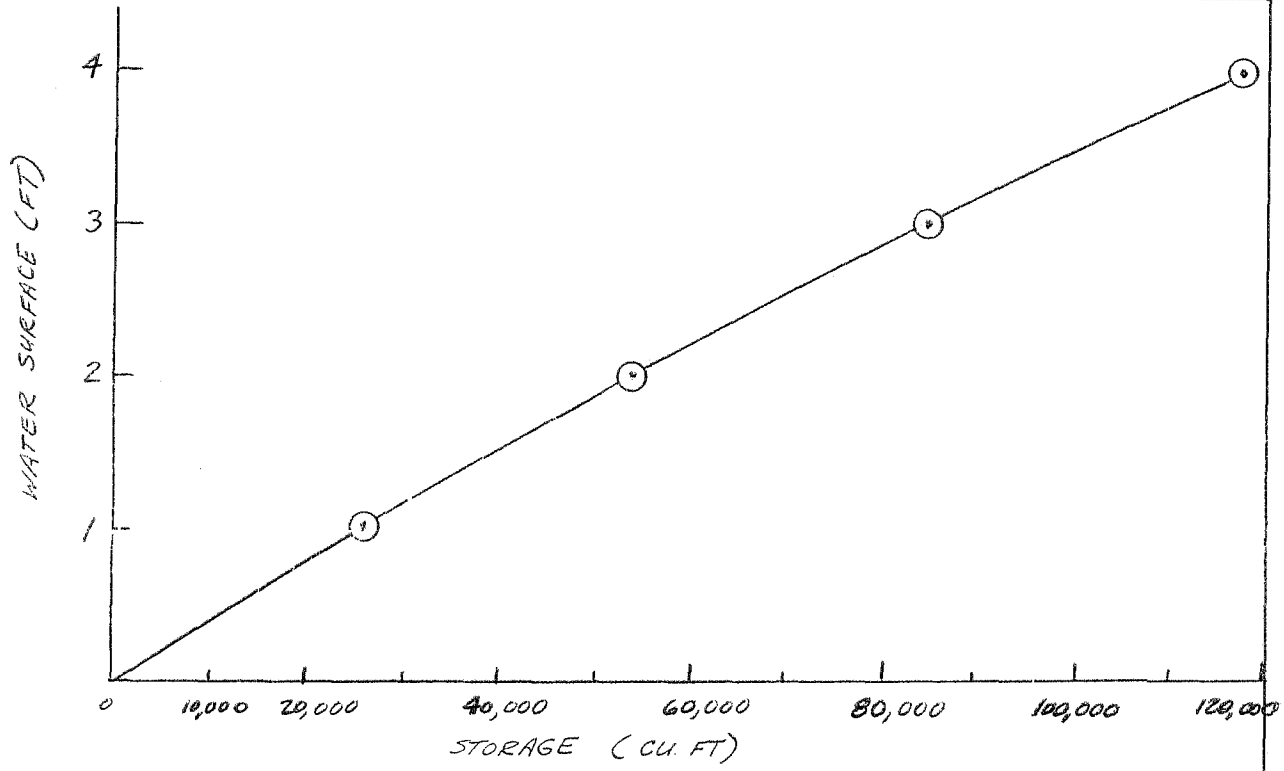

STAGE-STORAGE GRAPH (From Table 1)

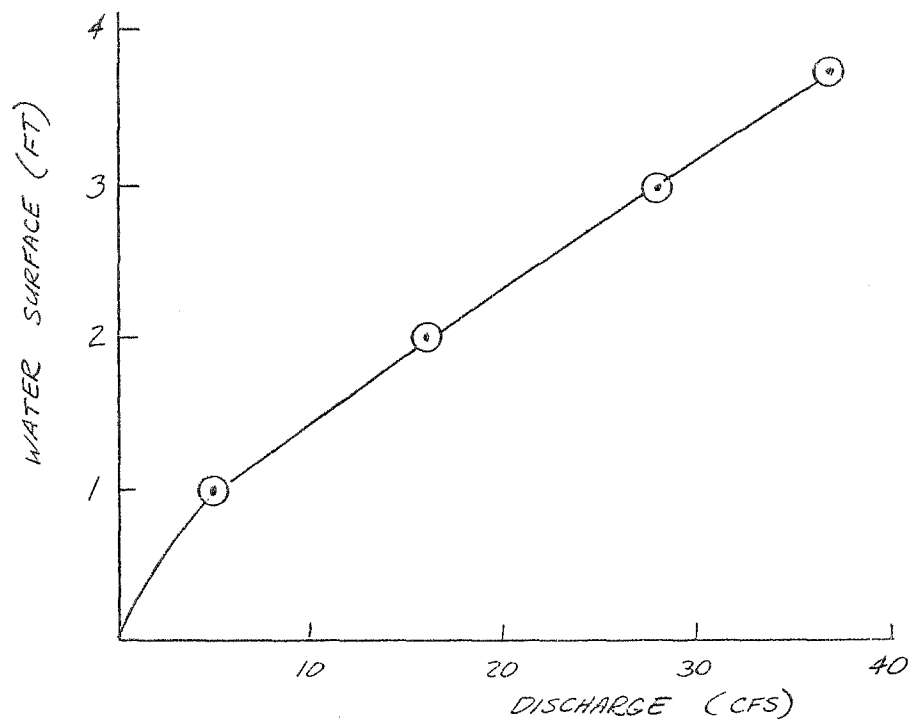

STAGE-DISCHARGE GRAPH (From Table 2)



CITY OF
LITTLE ROCK

Title

DETENTION BASIN
DESIGN

No.

Issue Date

4/8/85

Page 6 of 11

Revision Date

DEPARTMENT OF
PUBLIC WORKS

Approved By

M. Botic

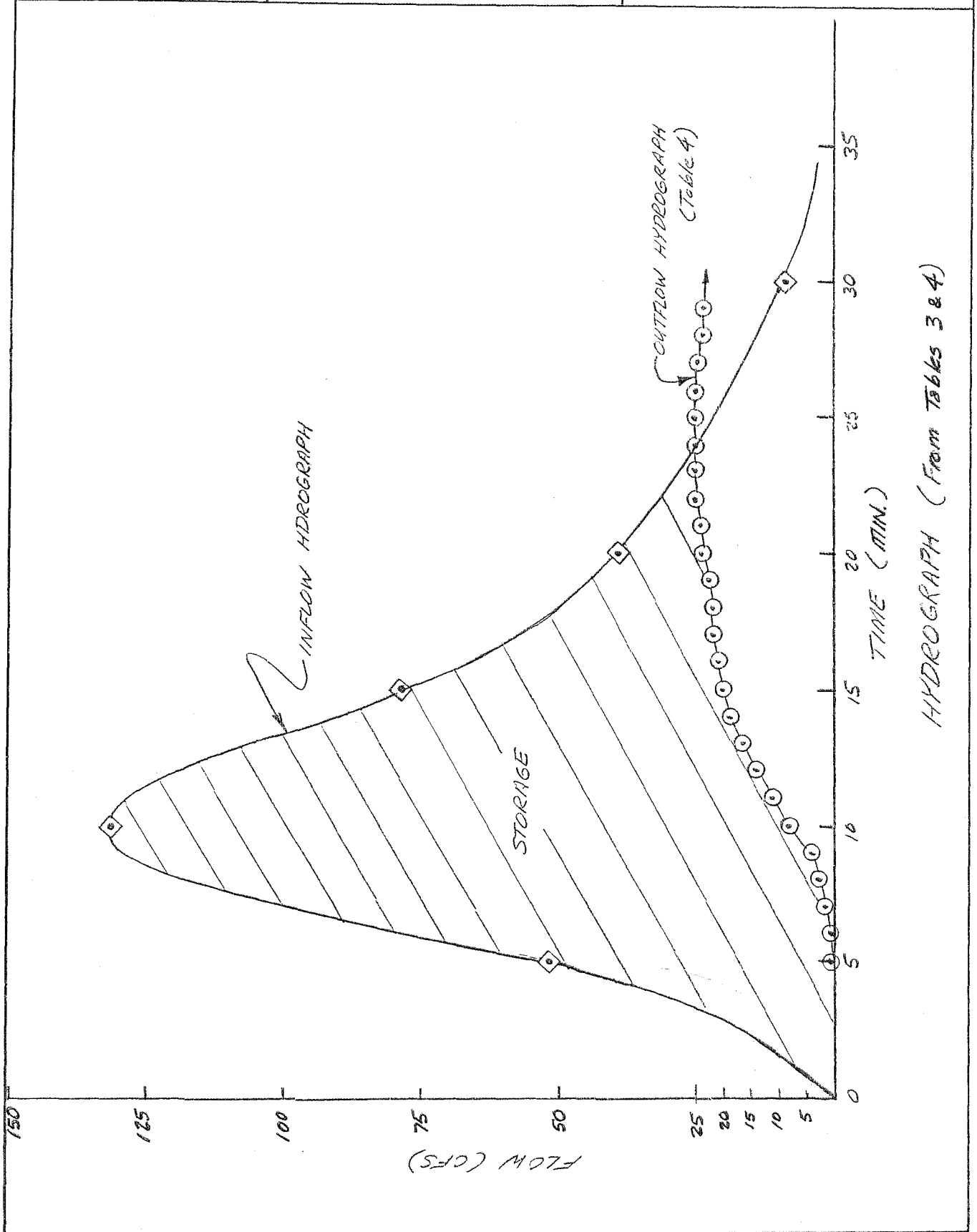



CITY OF
LITTLE ROCK

Title

DETENTION BASIN
DESIGN

No.

Issue Date

4/8/85

Page 7 of 11

Revision Date

DEPARTMENT OF
PUBLIC WORKS

Approved By M. Batie

Set @ $\frac{\Delta t_p}{10} = 1 \text{ minute}$, Then $\Delta S_{i,j} = (I_i - O_i) \Delta T_{i,j}$
 $\Delta S_{i,j} = (I_i - O_i)(1 \text{ min.})(60 \frac{\text{sec}}{\text{min.}})$
 $= \Delta S \text{ in cubic feet}$

TABLE 4. STORAGE & OUTFLOW

i/j	TIME (min.)	INFLOW (CFS)*	STORAGE (FT ³ × 10 ³) [†]	OUTFLOW (CFS)	i/j	TIME (min.)	INFLOW (CFS)	STORAGE (FT ³ × 10 ³)	OUTFLOW (CFS)
		(1)		(2)				+ 4.26	
1	0	0	0	0	16	15	79	63.30	20
			$\Delta S = 0$					+ 3.54	
2	1	5	0	0	17	16	67	66.84	21
			$\Delta S = .30$					2.76	
3	2	13	.30	0	18	17	57	69.60	22
			+ 1.78					2.10	
4	3	23	1.08	0	19	18	48	71.70	22
			+ 1.38					1.56	
5	4	35	2.46	0	20	19	43	73.26	23
			+ 2.10					1.20	
6	5	52	4.56	1	21	20	39	74.46	24
			+ 3.06					.90	
7	6	80	7.62	1	22	21	35	75.36	24
			+ 4.74					.66	
8	7	103	12.36	2	23	22	32	76.02	25
			+ 6.06					.42	
9	8	118	18.42	3	24	23	28	76.44	25
			+ 6.90					.18	
10	9	128	25.32	4	25	24	26	76.62	25
			+ 7.44					.06	
11	10	131	32.76	8	26	25	23	76.68	25 ← PEAK
			+ 7.38					-.12	
12	11	128	40.14	11	27	26	19	76.56	25
			+ 7.02					-.36	
13	12	120	47.16	14	28	27	16	76.20	25
			+ 6.36					-.54	
14	13	108	53.52	16	29	28	14	75.66	24
			+ 5.52					-.60	
15	14	90	59.04	19			11	75.06	24

* From hydrograph, page 6.

** (1)-(2) = ΔS ; page 5.

 CITY OF LITTLE ROCK	Title DETENTION BASIN DESIGN	No.	Page 8 of 11
		Issue Date 4/8/85	Revision Date
DEPARTMENT OF PUBLIC WORKS		Approved By M. Botie	

BASIN CHARACTERISTICS :

<u>ITEM</u>	<u>PRELIMINARY DESIGN</u>	<u>AS ROUTED</u>
1. Outflow Peak	48 cfs	50 cfs
2. Storage Required	66,483 ft ³	76,680 ft ³
3. Water Level	3' + 1' Freeboard	2.75' + 1.25' Freeboard

SUMMARY :

- (1) Use 2-30" ϕ CP, 48 cfs \approx 50 cfs \therefore OK ; Area OK.
The designer may want to check 2-24" ϕ CP with a slightly smaller basin to increase head. This would be a refinement of the original design.
- (2) If designer is satisfied with the above design and does not want to check other pipe sizes or basin dimensions, he should next check basin performance under 100-year storm conditions. Prepare 100-year storm hydrograph to see if basin components will be adequate or will be damaged.

 CITY OF LITTLE ROCK	Title DETENTION BASIN DESIGN	No.	Page 9 of 11
		Issue Date 4/8/85	Revision Date
DEPARTMENT OF PUBLIC WORKS		Approved By M. Batic	

100 Year Flow

$$Q = CIA \quad C = .91$$

$$I = 8.8 \text{ in/hr}$$

$$A = 20 \text{ AC}$$

$$Q = CIA = (.91)(8.8)(20) = 160 \text{ cfs}$$

Possible Outlet Structure Options:

- (1) Typical Outlet structure (Ex: See Fig. 5-6).
25 year pipes + 100 year pipes (no weir)
- (2) 25 year pipes + 100 year weir flow.
- (3) 25 year pipes + a combination outlet pipe system and weir system for 100 year flow. (see Fig. 5-6).

For this example, use option 1. Note, option 3 will probably give decreased 100 year pipe costs. However, maintenance cost may increase with weirs.

For an approximate 100 yr flow pipe size, assume $HW \approx 4.0'$

Try 2-36" \emptyset $\frac{HW}{D} = 1.14$ $Q = 2 \times 41 \text{ cfs} = 82 \therefore \text{N.G.}$

Try 4-36" \emptyset $Q = 4 \times 41 = 164 \text{ cfs} \therefore \text{OK}$
 However, Cover for pipes may be a problem.
 Try smaller pipe.

Try 5-30" \emptyset $\frac{HW}{D} = \frac{4}{2.5} = 1.6$ $Q = 38 \text{ cfs}$
 $5 \times 38 \text{ cfs} = 190 \text{ cfs} \therefore \text{Too High}$

Try 5-24" \emptyset $\frac{HW}{D} = \frac{4}{2} = 2$ $Q = 26 \text{ cfs}$
 $5 \times 26 \text{ cfs} = 130 \text{ cfs} \therefore \text{Too Low}$

Try 4-30" $\emptyset \Rightarrow 4 \times 38 = 152 \text{ cfs} \approx 160 \text{ cfs}$
 Close enough.

Use 4-30" \emptyset CP for 100 year discharge ←

NOTE: IF cover was not a problem, larger pipe could be used; therefore fewer pipe would be needed.



CITY OF
LITTLE ROCK

Title

DETENTION BASIN
DESIGN

No.

Issue Date
4/8/85

Page 10 of 11

Revision Date

DEPARTMENT OF
PUBLIC WORKS

Approved By M. Bartie

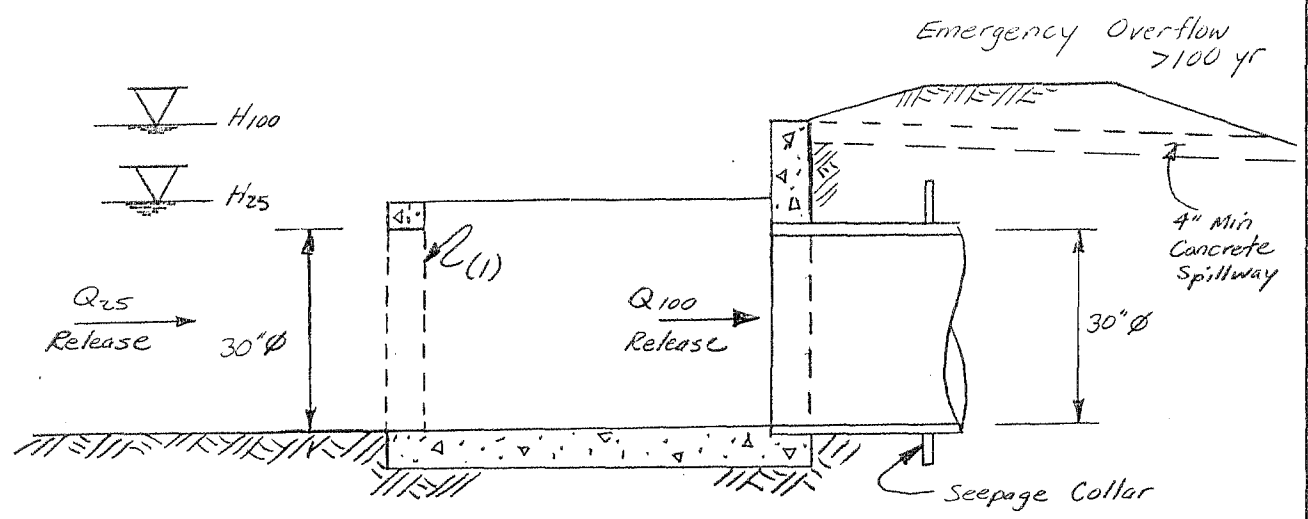
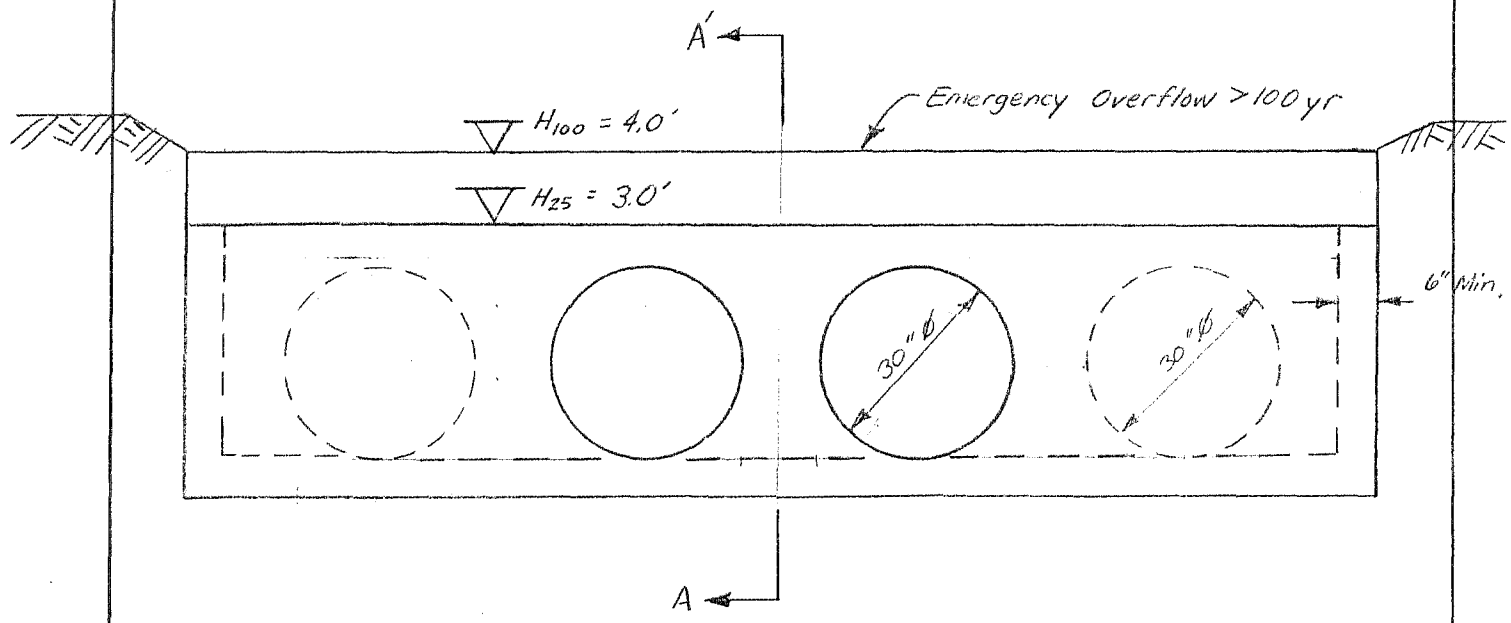

SECTION A-A'

OUTLET STRUCTURE

NOTE: (1) Q_{25} Release portion of the structure may have any other configuration, as long as it is hydraulically equivalent to the 30" ϕ CP. The designer should route the outflow hydrograph using a stage-discharge graph for the chosen discharge configuration.

 CITY OF LITTLE ROCK	Title DETENTION BASIN DESIGN	No.	Page // of //
		Issue Date 4/8/95	Revision Date
DEPARTMENT OF PUBLIC WORKS		Approved By M. Batie	

REFERENCES:

1. American Society of Civil Engineers, Stormwater Detention Facilities; Proceedings, ASCE, 1982.
2. American Public Works Association, Practices In Detention of Urban Stormwater Runoff, Special Report No. 43, APWA, June 1974.
3. American Public Works Association, Urban Stormwater Management, Special Report No. 49, APWA, 1981.
4. The Urban Land Institute, A Handbook of Measures To Protect Water Resources In Land Development, ULI, 1981.
5. Linsley and Franzini, Water - Resources Engineering, 2nd Ed., McGraw-Hill, 1972.
6. Clark, Viessman, and Hammer, Water Supply and Pollution Control, International Textbook Company, 1971.
7. Viessman, Harbaugh, and Knapp, Introduction to Hydrology, Intext, 1972.
8. McCuen, A Guide To Hydrologic Analysis Using SCS Methods, Prentice-Hall, 1982.
9. Chow, Handbook of Applied Hydrology, McGraw-Hill, 1964.

TABLE 2.2 RUNOFF COEFFICIENTS FOR RATIONAL METHOD COMPOSITE ANALYSIS

CHARACTER OF SURFACE	RUNOFF COEFFICIENTS		
	FREQUENCY		
	10	25	100
<u>Undeveloped Areas:</u>			
Historic Flow Analysis, Greenbelts, Agricultural, Natural Vegetation			
Clay Soil			
Flat, 2%	.30	.33	.37
Average, 2-7%	.40	.44	.50
Steep 7%	.50	.55	.62
Sandy Soil			
Flat, 2%	.12	.13	.15
Average, 2-7%	.20	.22	.25
Steep 7%	.30	.33	.37
<u>Streets:</u>			
Paved	.90	.92	.95
Gravel	.35	.50	.65
<u>Drives and Walks:</u>			
	.90	.91	.92
<u>Roofs:</u>			
	.90	.92	.95
<u>Lawns:</u>			
Clay Soil			
Flat, 2%	.18	.20	.25
Average, 2-7%	.22	.28	.35
Steep, 7%	.35	.45	.60
Sandy Soil			
Flat, 2%	.10	.25	.40
Average, 2-7%	.15	.30	.45
Steep, 7%	.20	.35	.50

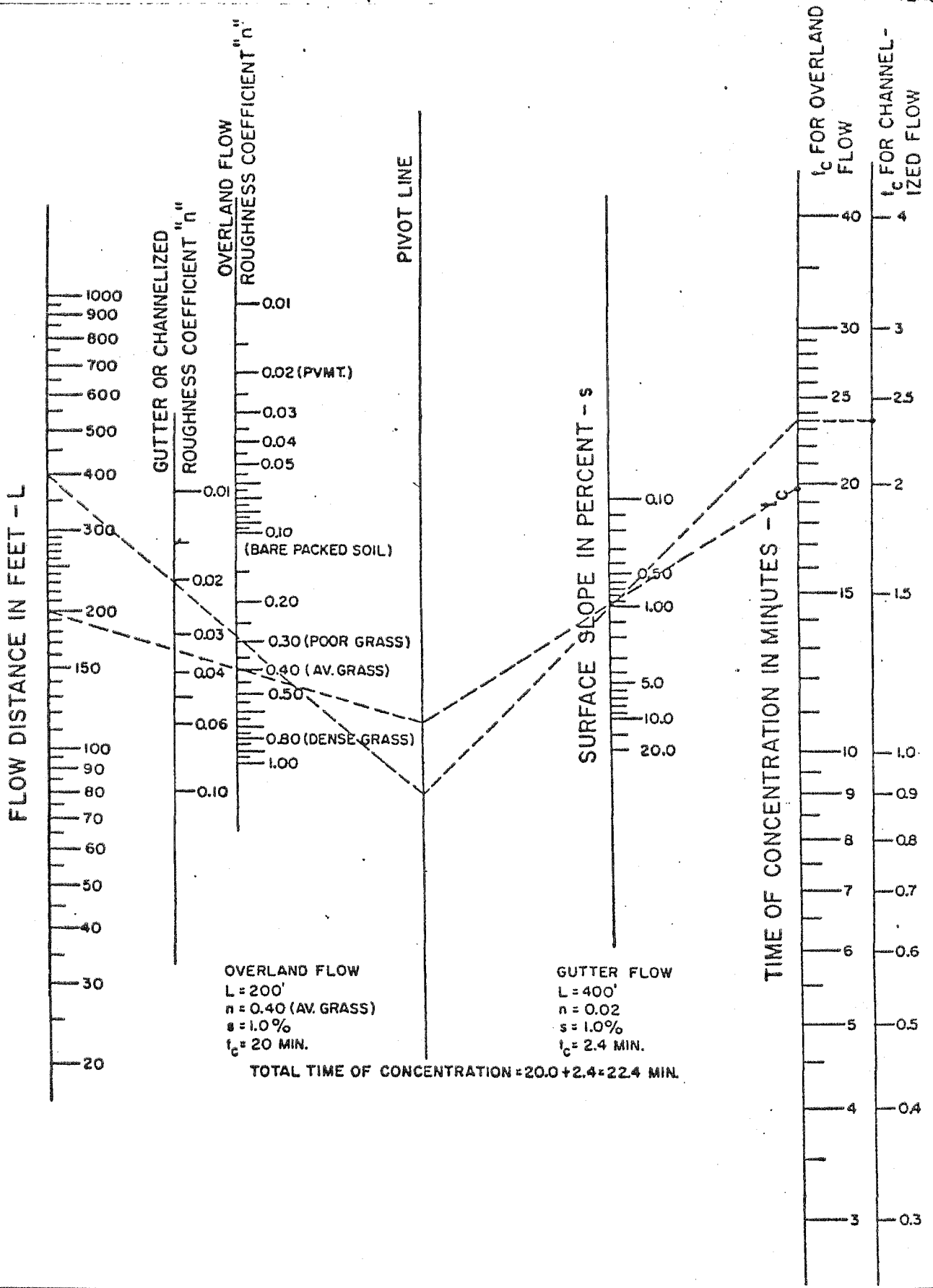

NOMOGRAPH FOR TIME OF CONCENTRATION

SOURCE: City of Fort Worth, Tx.

INTENSITY - DURATION - FREQUENCY

LITTLE ROCK

SOURCE: HYDRO 35 & T.P. No. 40

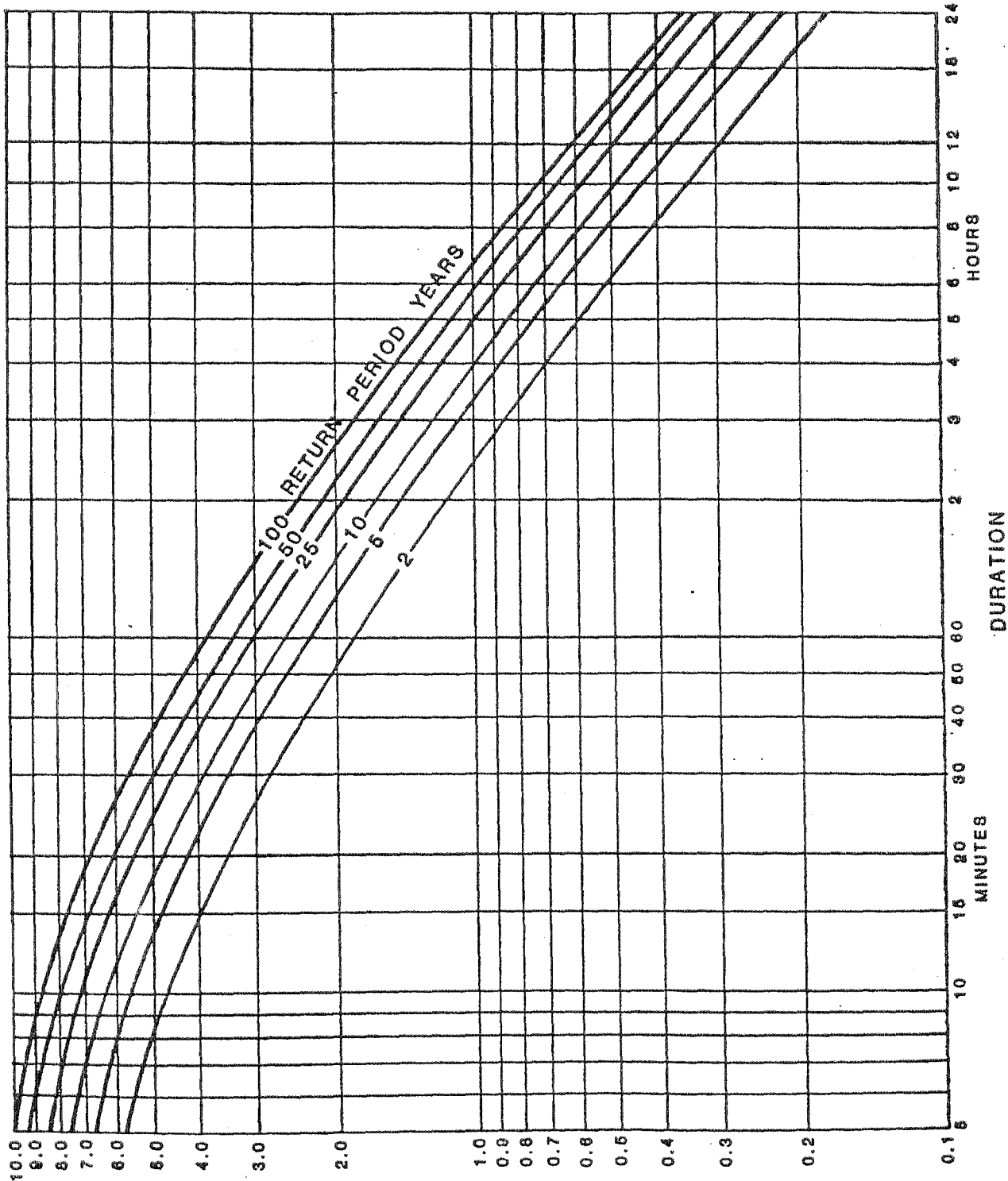

RAINFALL INTENSITY IN INCHES PER HOUR

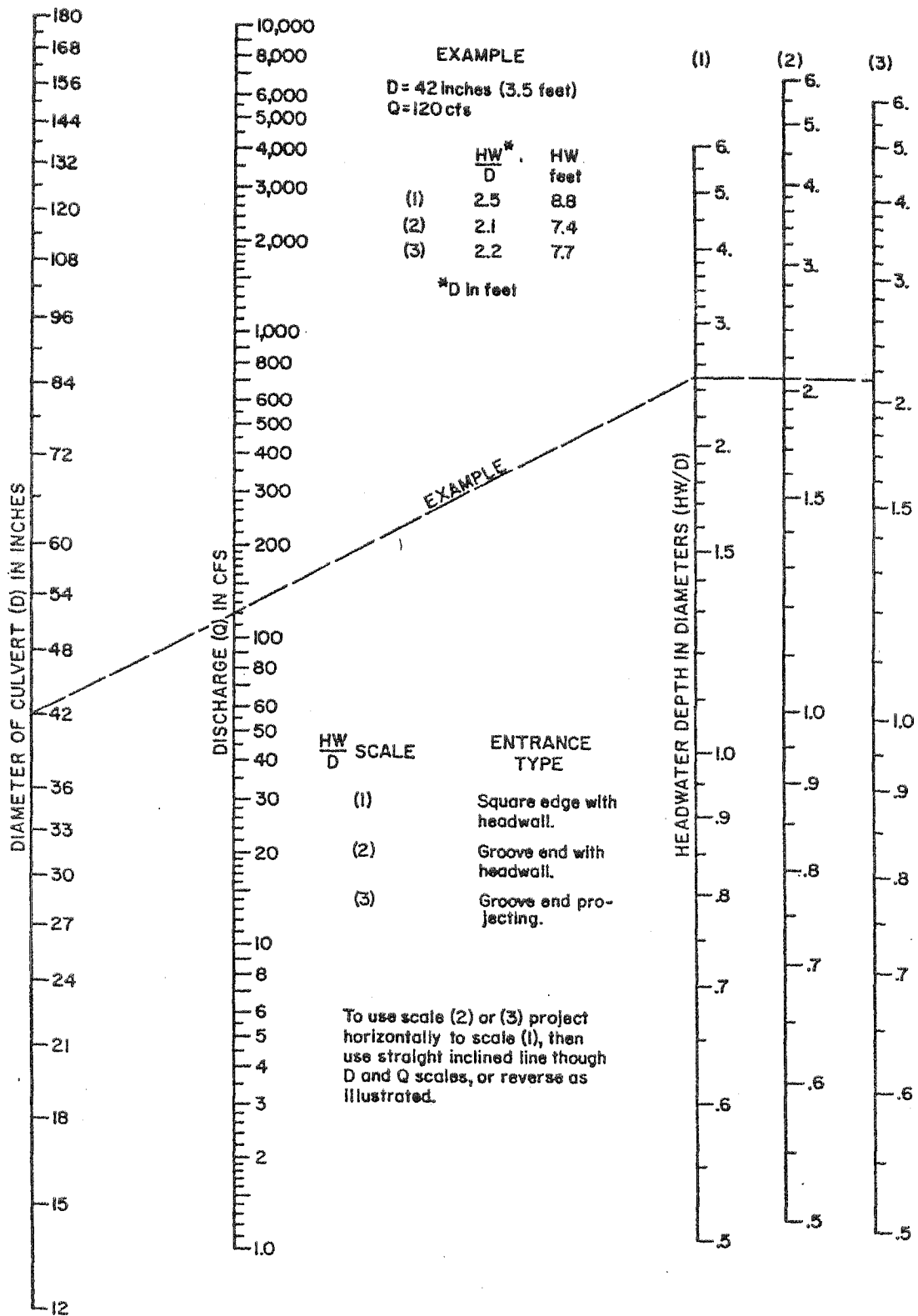

SECTION VI - PAVEMENT DRAINAGE DESIGN

6.1 General

- 6.1.1 Interference Due to Flow in Streets
- 6.1.2 Interference Due to Ponding
- 6.1.3 Interference Due to Water Flowing
Across Traffic Lane
- 6.1.4 Affect on Pedestrians
- 6.1.5 Reduction of Allowable Carrying Capacity

6.2 Permissible Spread of Water

- 6.1.1 Industrial and Arterial Streets
- 6.1.2 Minor Arterial and Collector Streets
- 6.1.3 Residential Collector Streets
- 6.1.4 Residential Streets

6.3 Bypass

6.4 Minimum and Maximum Velocities

6.5 Design Method

- 6.5.1 Straight Crowns
- 6.5.2 Parabolic Crowns

SECTION VI - FLOW IN STREETS

6.1 GENERAL

The location of inlets and permissible flow of water in the streets should be related to the extent and frequency of interference to traffic and the likelihood of flood damage to surrounding property. Interference to traffic is regulated by design limits on the spread of water into traffic lanes, especially in regard to arterials. Flooding of surrounding property from streets is controlled by limiting curb build up to the top of the curb for a 25-year storm.

6.1.1 INTERFERENCE DUE TO FLOW IN STREETS

Water which flows in a street, whether from rainfall directly on to the pavement surface or overland flow entering from adjacent land areas, will flow in the gutters of the street until it reaches an overflow point for some outlet, such as a storm sewer inlet. As the flow progresses downhill and additional areas contribute to the runoff, the width of flow will increase and progressively encroach into traffic lane. On streets where parking is not permitted, as with many arterial streets, flow widths exceeding a few feet become a traffic hazard. Field observations show that vehicles will crowd adjacent lanes to avoid curb flow.

As the width of flow increases further, it becomes impossible for vehicles to operate without moving through water and they again use the now inundated lane. Splash from vehicles traveling in the inundated lane obscures the vision of drivers of vehicles moving at a high rate of speed in the open lane. Eventually, if width and depth of flow become great enough, the street loses its effectiveness as a traffic-carrier. During these periods, it is imperative that emergency vehicles such as fire trucks, ambulances, and police cars be able to transverse the streets by moving along the crown of the roadway.

6.1.2 INTERFERENCE DUE TO PONDING

Storm runoff ponded on the street surface because of grade changes or the crown slope of intersecting streets has a substantial effect on the street's traffic carrying capacity. Because of the localized nature of ponding, vehicles moving at a relatively high speed may enter a pond. The manner in which ponded water affects traffic is essentially the same as for curb flow, that is, the width of spread into the traffic lane is critical. Ponded water will often completely halt all traffic. Ponding in streets has the added hazard of surprise to drivers of moving vehicles, often producing erratic and dangerous responses.

6.1.3 INTERFERENCE DUE TO WATER FLOWING ACROSS TRAFFIC LANE

Whenever stormwater runoff, other than limited sheet flow, moves across the traffic lane, a serious and dangerous impediment to traffic flow occurs. The cross-flow may be caused by super elevation of the curb, a street intersection, overflow from the higher gutter on a street with cross fall, or simply poor street design. The problem associated with this type of flow is the same as for ponding in that it is localized in nature. Vehicles may be traveling at high speed when they reach the location. If vehicular movement is slow and the street is lightly traveled, as on residential streets, limited cross flows do not cause sufficient interference to be unacceptable.

The depth and velocity of cross flows shall be maintained within such limits that do not have sufficient force to threaten moving traffic.

6.1.4 EFFECT ON PEDESTRIANS

In areas with heavily used sidewalks, splash due to vehicles moving through water adjacent to the curb is a serious problem.

Streets should be classified with respect to pedestrian traffic as well as vehicular traffic. As an example, streets which are classified as residential vehicles and located adjacent to a school are arterials for pedestrian traffic. The allowable width of gutter flow and extent of ponding should reflect this fact.

6.1.5 REDUCTION OF ALLOWABLE CARRYING CAPACITY

As the stormwater flow approaches an arterial street, tee intersection, or cul-de-sac, the allowable carrying capacity shall be calculated by multiplying the reduction factor from Figure 6.1 times the theoretical gutter capacity. The grade used to determine the reduction factors shall be the same effective grade used to calculate the theoretical capacity.

6.2 PERMISSIBLE SPREAD OF WATER

6.2.1 INDUSTRIAL AND ARTERIAL STREETS

Inlets shall be spaced at such an interval as to provide one clear traffic lane in each direction during the peak flows of the design storm.

Use of depressed inlets adjacent to a traffic lane is discouraged. However, gutter depressions may not exceed 2 1/2 inches unless specifically approved by the City Engineer. The design storm will have a 25-year return frequency.

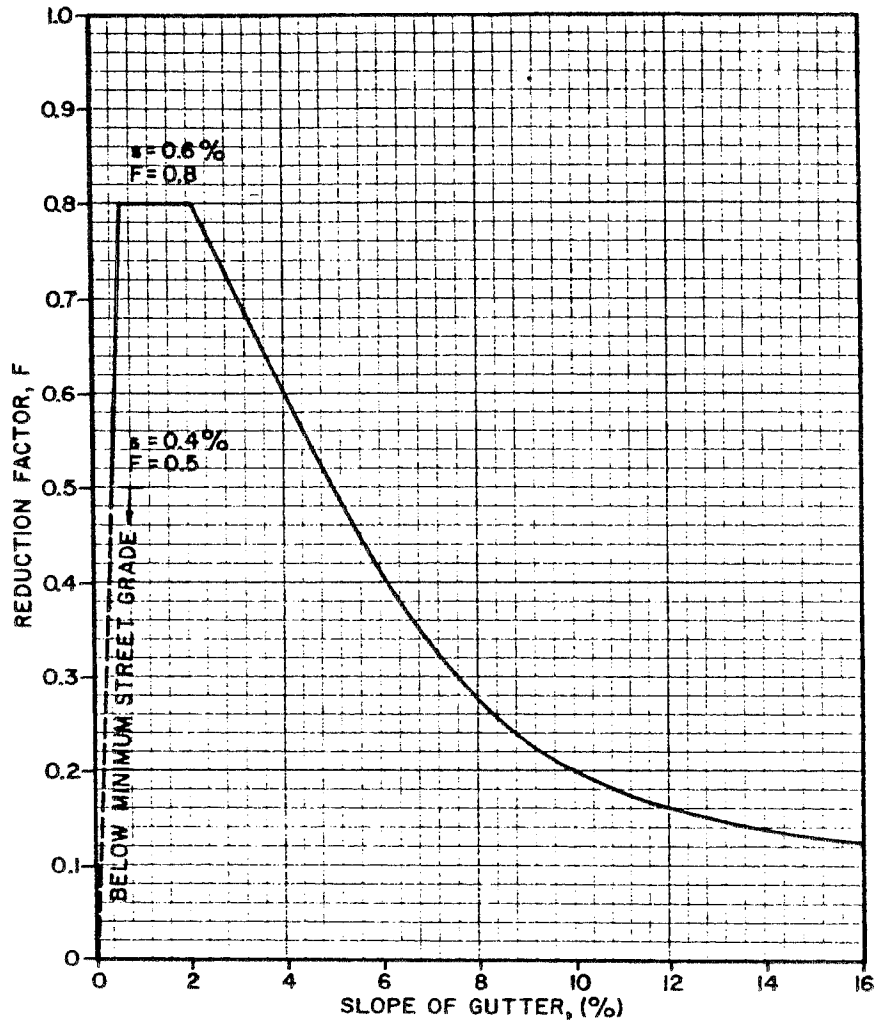

REDUCTION FACTOR FOR ALLOWABLE GUTTER CAPACITY

Example:

Street width 60 feet; two 12-foot lanes to remain clear.

Therefore: street flow in each gutter shall not exceed $(60 - 24)/2 = 18$ feet.

6.2.2 MINOR ARTERIAL AND COLLECTOR STREETS

The flow of water in gutters of the neighborhood collector streets shall be limited so that one standard lane will remain clear during the peak runoff from the design storm. Inlets shall be located at low points or wherever the flow exceeds the one standard lane requirement. Gutter depression at the inlets is discouraged, but shall not exceed 5 inches in any case. The design storm will have a 25-year return frequency.

Example: Street width 44 ft.; one 12-foot traffic lane to remain clear.

Therefore: street flow in each gutter shall not exceed $(44 - 12)/2 = 16$ ft.

6.2.3 RESIDENTIAL COLLECTOR STREETS

The flow of water in gutters of a residential collector street shall be limited so that one standard lane will remain clear during the peak runoff from the design storm. Inlets shall be located at low points or wherever the flow exceeds the one standard lane requirement. Gutter depression at the inlet is discouraged, but shall not exceed 5 inches in any case. The design storm will have a 25-year return frequency.

Example: street width - 36 ft.; one 12-foot traffic lane to remain clear.

Therefore: street flow in each gutter shall not exceed $(36 - 12)/2 = 12$ ft.

6.2.4 RESIDENTIAL STREETS

The flow of water in gutters of a residential street shall be limited to a depth of flow at the curb of 6 inches or wherever the street is just covered, whichever is the least depth. Inlets shall be located at low points, or wherever the gutter flow exceeds a permissible spread of water. In no case shall the gutter depression at the inlet exceed 5 inches. The design storm will have a 25-year return frequency.

6.3 BYPASS

Flow bypassing each inlet must be included in the total gutter flow to the next inlet downstream. A bypass of 10 to 20 percent per inlet will result in a more economical drainage system.

6.4 MINIMUM AND MAXIMUM VELOCITIES

To ensure cleaning velocities at very low flows, the gutter shall have a minimum slope of 0.004 feet per foot (0.4%). The maximum velocity of curb flow shall be 10 feet per second. Along sharp horizontal curves, peak flows tend to jump behind the curb line at driveways and other curb breaks. Water running behind the curb line can result in considerable damage due to erosion and flooding. In a gutter where the slope is greater than 0.10 feet per foot (10%) and the radius is 400 feet or less, design depth of flow shall not exceed 4 inches at the curb.

6.5 DESIGN METHOD

6.5.1 STRAIGHT CROWNS

Flow in gutters which are straight crown pavements is normally calculated by using Manning's equation for various hydraulic properties for uniform flow in pavement gutters and triangular channels. The equation is:

$$Q_0 = 0.56 \frac{z}{n} S_0^{1/2} Y_0^{8/3}$$

Q_0 = gutter discharge (CFS)

z = reciprocal of the crown slope (foot per foot)

S_0 = street or gutter slope (foot per foot)

n = roughness coefficient

Y_0 = depth of flow in gutter (foot)

The nomograph in Figure 6-2 provides for direct solution of flood conditions for triangular channels most frequently encountered in urban drainage design. For the usual concrete gutter, a value of 0.016 for "n" is recommended.

6.5.2 PARABOLIC CROWNS

Flow in gutters which are on parabolic crown pavements is calculated from a variation of Manning's equation for steady flow in a prismatic open channel. However, this equation becomes complicated and difficult to solve for each design

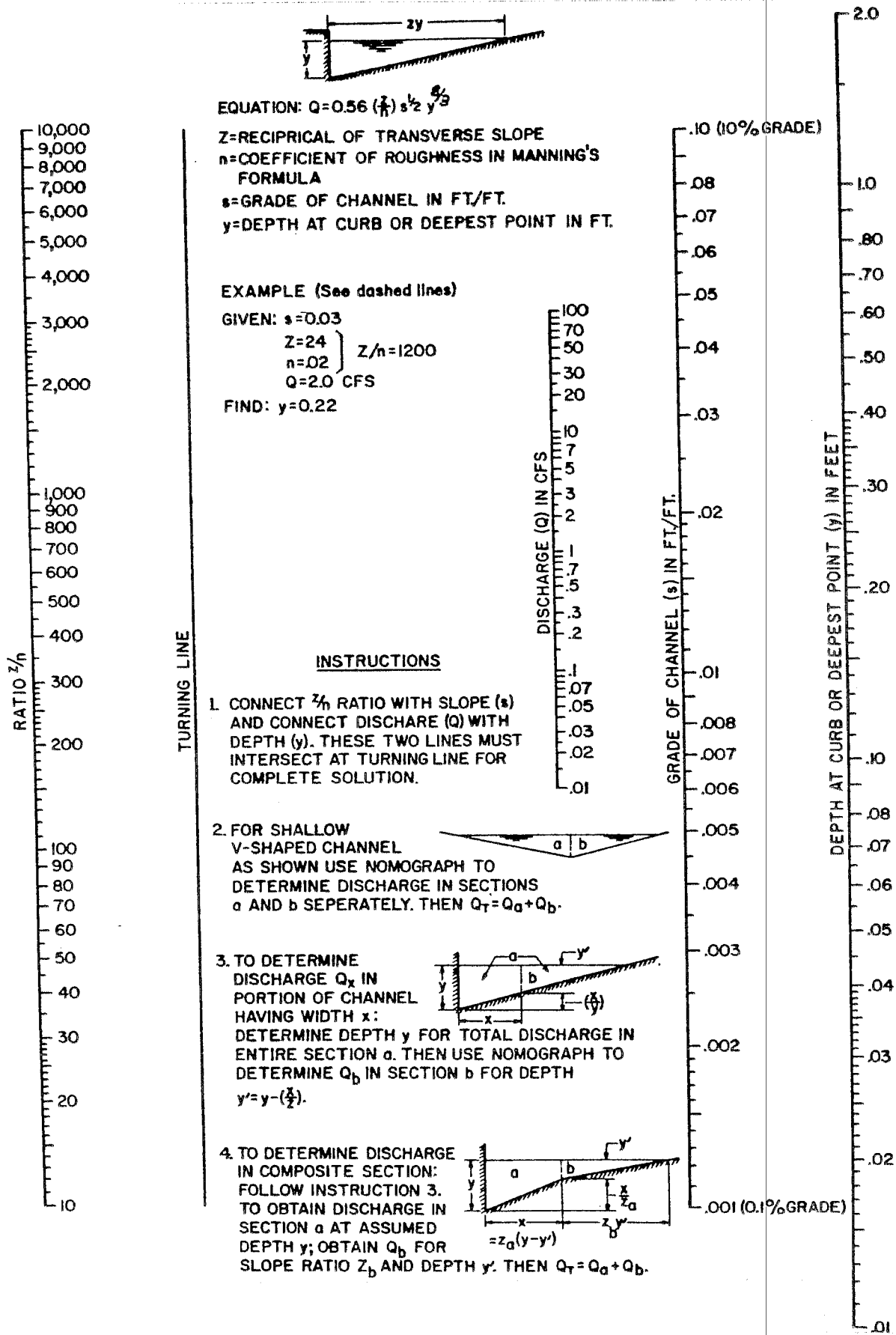

EQUATION: $Q = 0.56 \left(\frac{z}{n}\right) s^{1/2} y^{5/2}$
 Z=RECIPROCAL OF TRANSVERSE SLOPE
 n=COEFFICIENT OF ROUGHNESS IN MANNING'S FORMULA
 s=GRADE OF CHANNEL IN FT./FT.
 y=DEPTH AT CURB OR DEEPEST POINT IN FT.

EXAMPLE (See dashed lines)

GIVEN: $s=0.03$
 $Z=24$
 $n=0.02$ } $Z/n=1200$
 $Q=2.0$ CFS
 FIND: $y=0.22$

INSTRUCTIONS

1. CONNECT Z/n RATIO WITH SLOPE (s) AND CONNECT DISCHARGE (Q) WITH DEPTH (y). THESE TWO LINES MUST INTERSECT AT TURNING LINE FOR COMPLETE SOLUTION.
2. FOR SHALLOW V-SHAPED CHANNEL AS SHOWN USE NOMOGRAPH TO DETERMINE DISCHARGE IN SECTIONS a AND b SEPERATELY. THEN $Q_T = Q_a + Q_b$.
3. TO DETERMINE DISCHARGE Q_x IN PORTION OF CHANNEL HAVING WIDTH x: DETERMINE DEPTH y FOR TOTAL DISCHARGE IN ENTIRE SECTION a. THEN USE NOMOGRAPH TO DETERMINE Q_b IN SECTION b FOR DEPTH $y' = y - \left(\frac{x}{z}\right)$.
4. TO DETERMINE DISCHARGE IN COMPOSITE SECTION: FOLLOW INSTRUCTION 3. TO OBTAIN DISCHARGE IN SECTION a AT ASSUMED DEPTH y; OBTAIN Q_b FOR SLOPE RATIO Z_b AND DEPTH y' . THEN $Q_T = Q_a + Q_b$.

case. To provide a means of readily determining the flow in the gutter and the spread of water into the traffic lane, gutter flow curves have been prepared. Figures 6-3 through 6-33 represent flow curves for various combinations of street widths, parabolic crown heights, and curb splits.

The gutter flow curves represented for parabolic crowns with split curb heights are based on a field procedure for locating the street crown. The procedure is to allow the street crown to shift from street centerline toward the high 1/4 point of the street in a direct proportion to the amount of curb split. The maximum curb split occurs with the crown at 1/4 point of the street. The maximum allowable curb split for a street parabolic crowns is considered to be 0.02 feet per foot of street width.

Example Determination of Crown Location:

Given: 0.4 foot design split on 30-foot wide street

Maximum curb split = $0.02 \times \text{street width} = 30 \text{ feet} \times 0.02 = 0.6 \text{ feet}$

Maximum movement = $1/4 \text{ street width for } 30\text{-foot street} = 1/4 \times 30 \text{ feet} = 7.5 \text{ feet}$

Split movement = $(\text{design split} \times W) / (\text{maximum split} \times 4)$

Crown movement = $(4 \times 30) / (.6 \times 4) = 5 \text{ feet}$

A curb split that is determined by field survey, whether built intentionally or not, should be considered when determining the capacity of curb flow.

Special consideration should be given when working cross sections which has the pavement crown above the top of curb. When the crown exceeds the height of the top of curb, the maximum depth of water at the curb (Y_0) is the height of curb, not crown height.

For street sections where the water is allowed to cover the street, the crown height should be chosen with care when designing the parabolic section. The parabolic section which has the crown elevation equal to the top of curb elevation will carry more water than will a section which has a crown elevation 1 inch above the top of curb elevations.

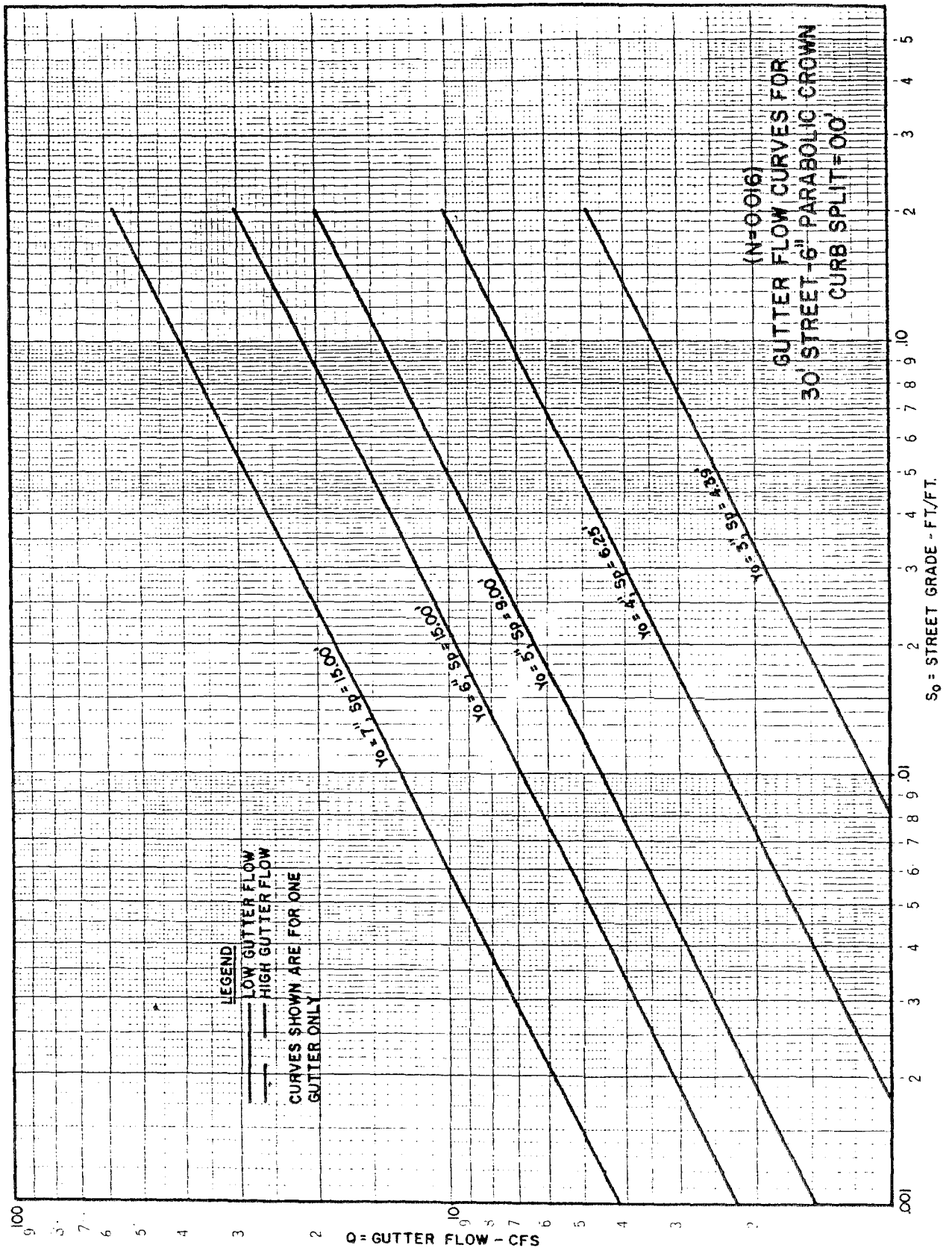

SOURCE: City of Austin, Tx. Fig. 6-3 - 6-31

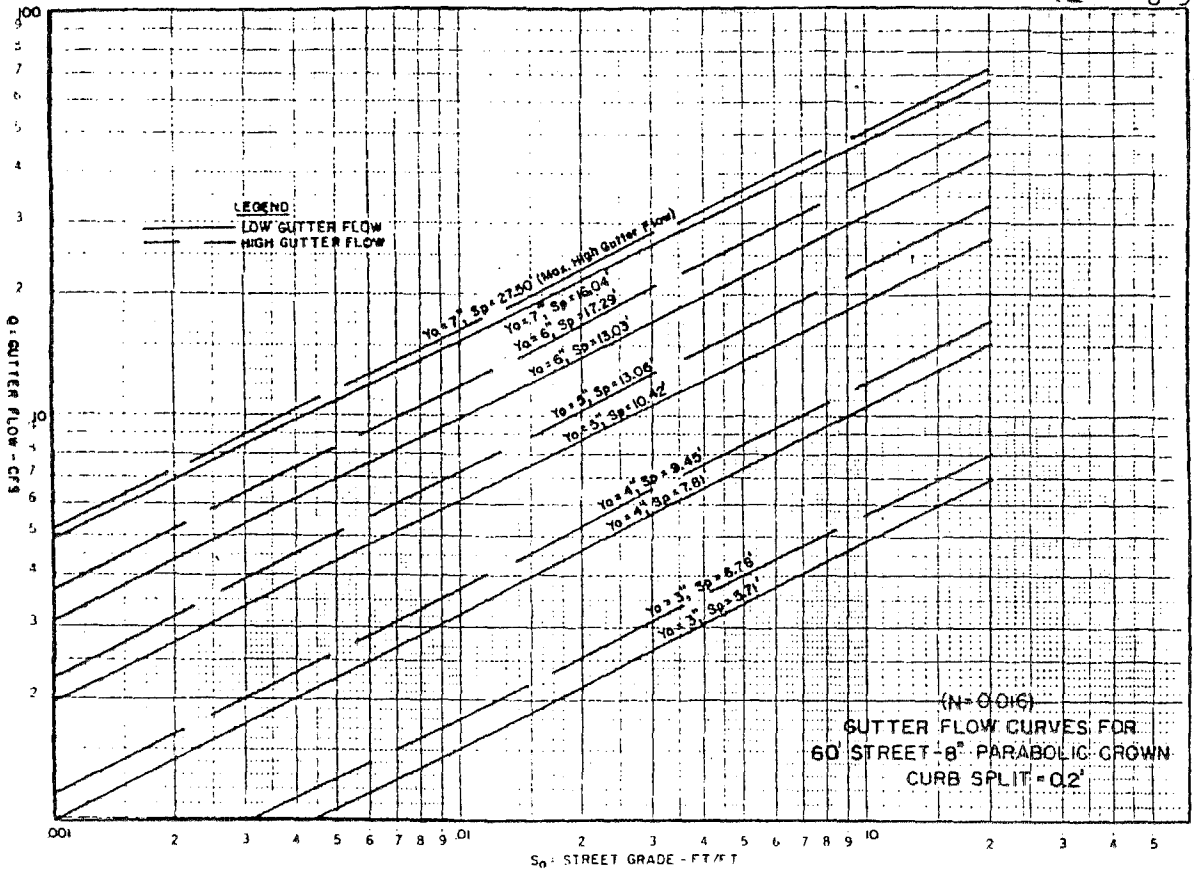

6-4
FIGURE

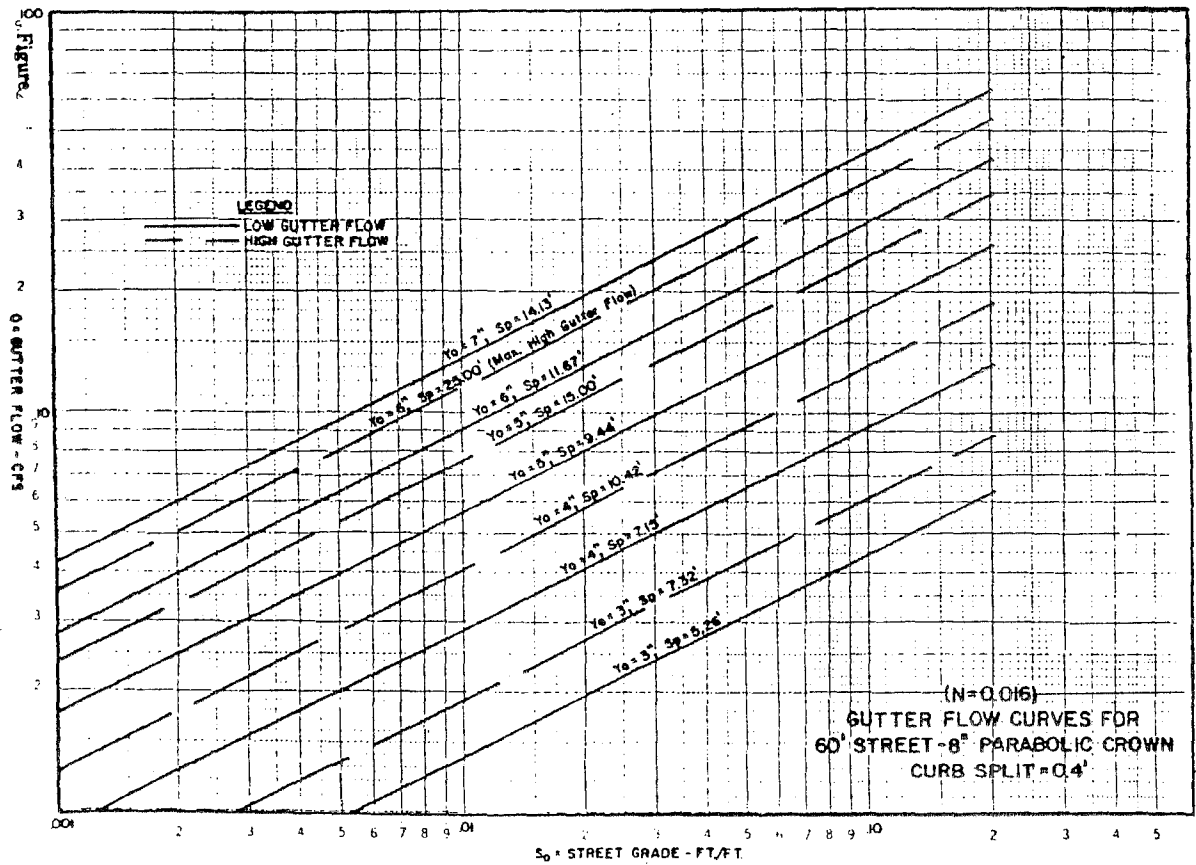

6-5
FIGURE

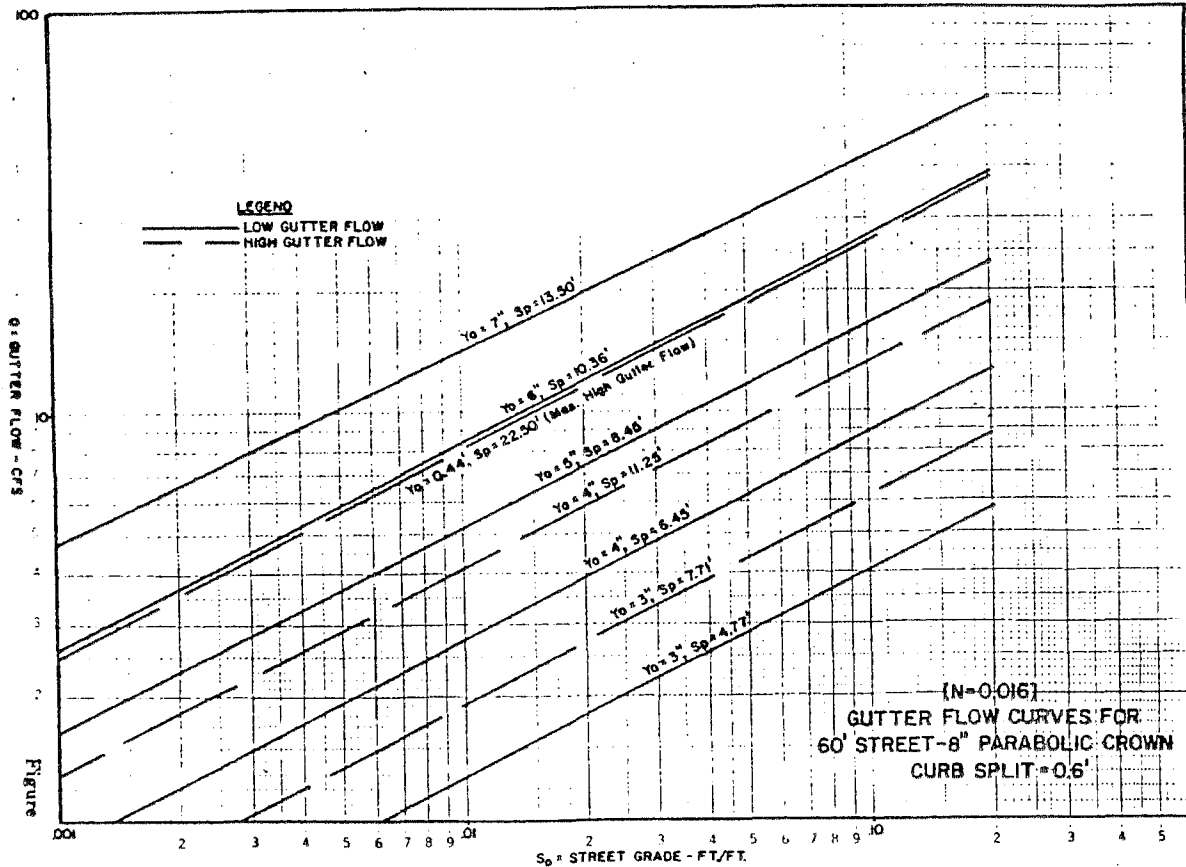

6-6
 FIGURE

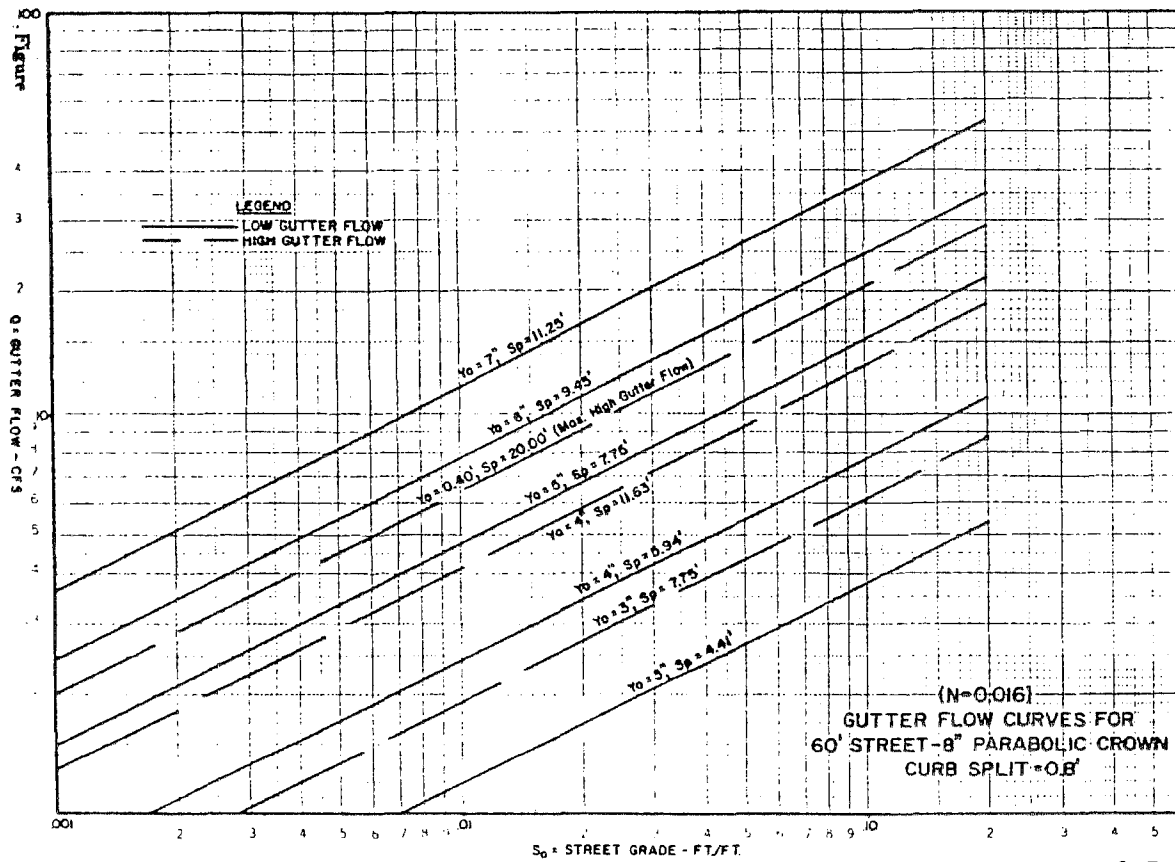

6-7
 FIGURE

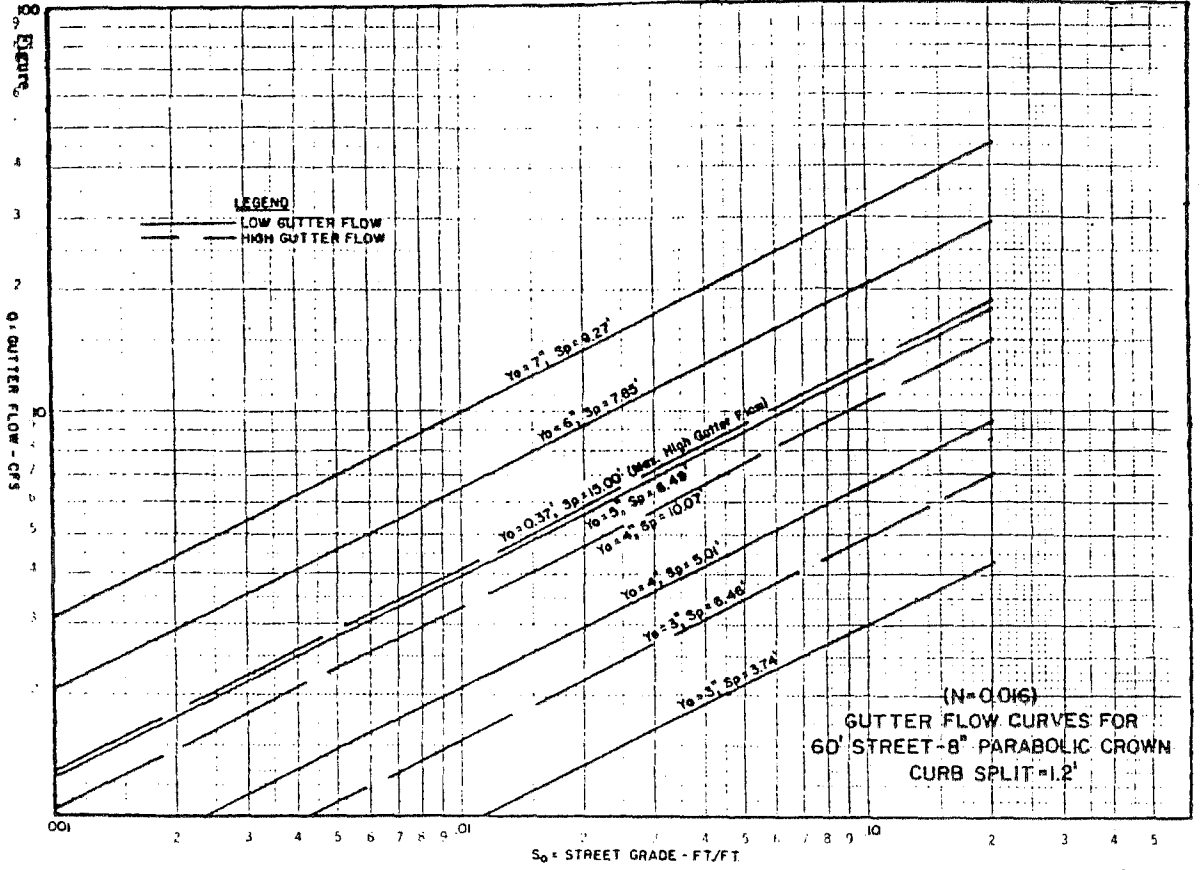

6-8

FIGURE

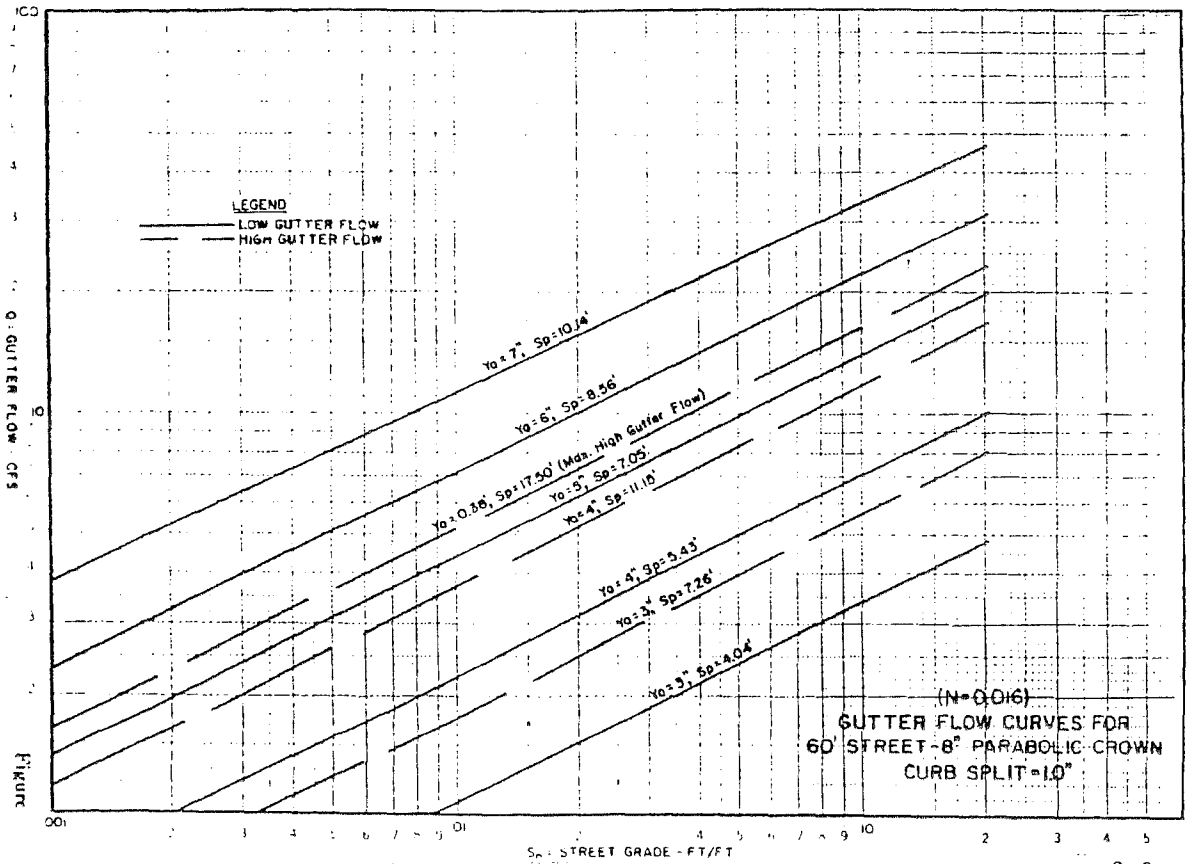

6-9

FIGURE

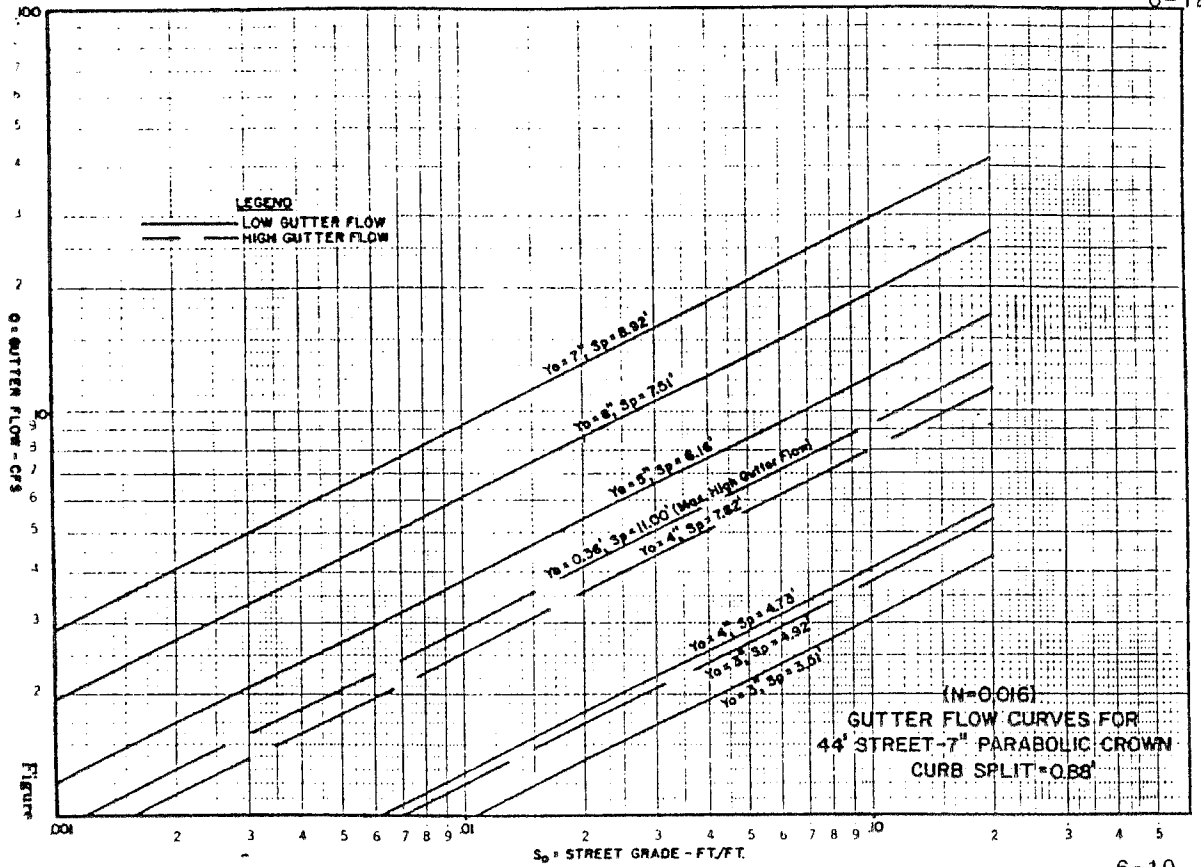

6-10
 FIGURE

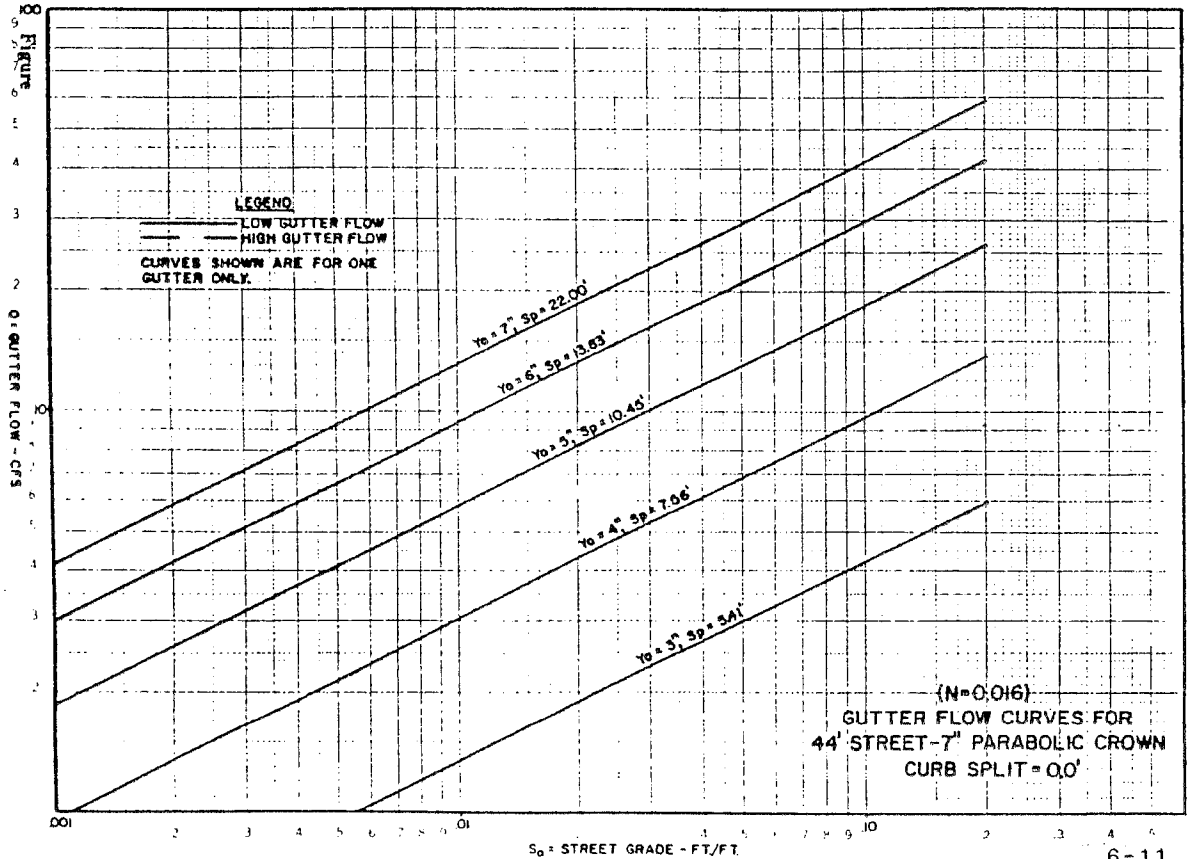

6-11
 FIGURE

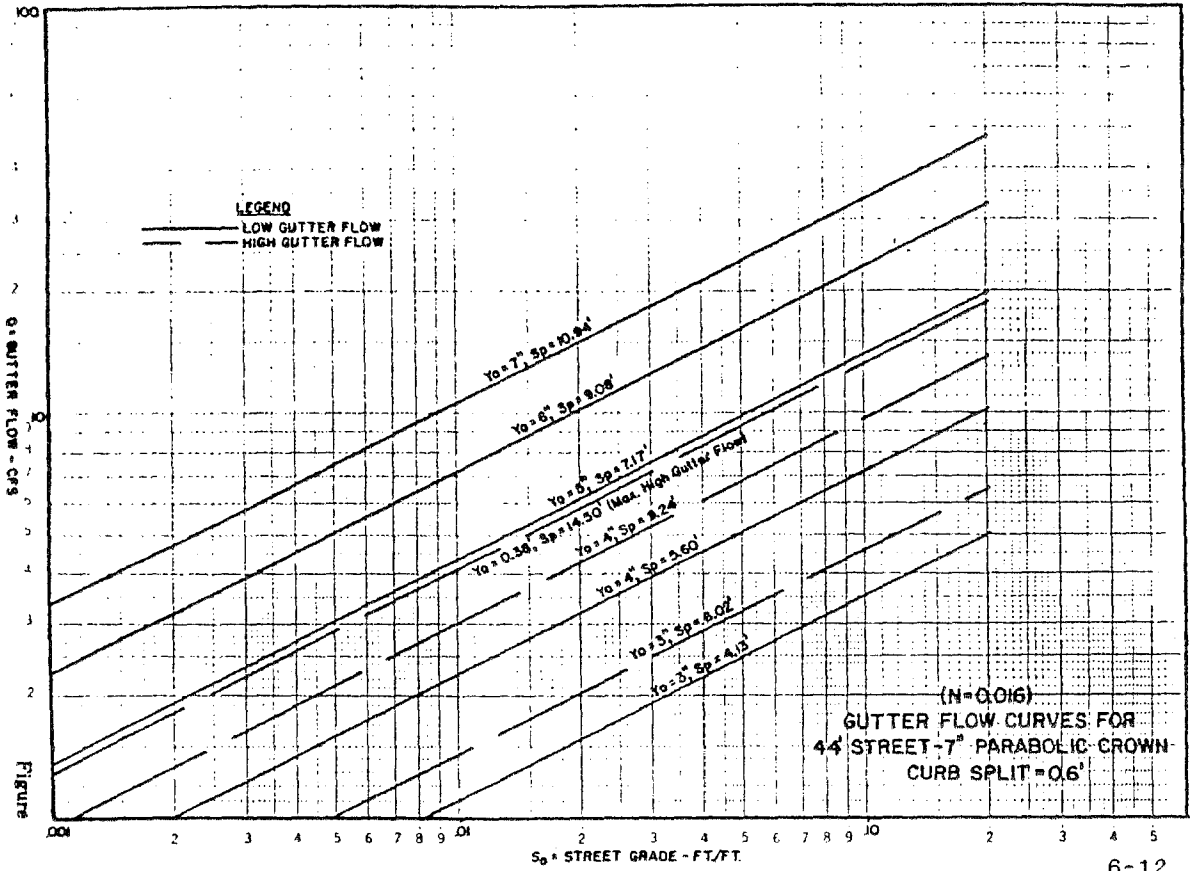

6-12

FIGURE

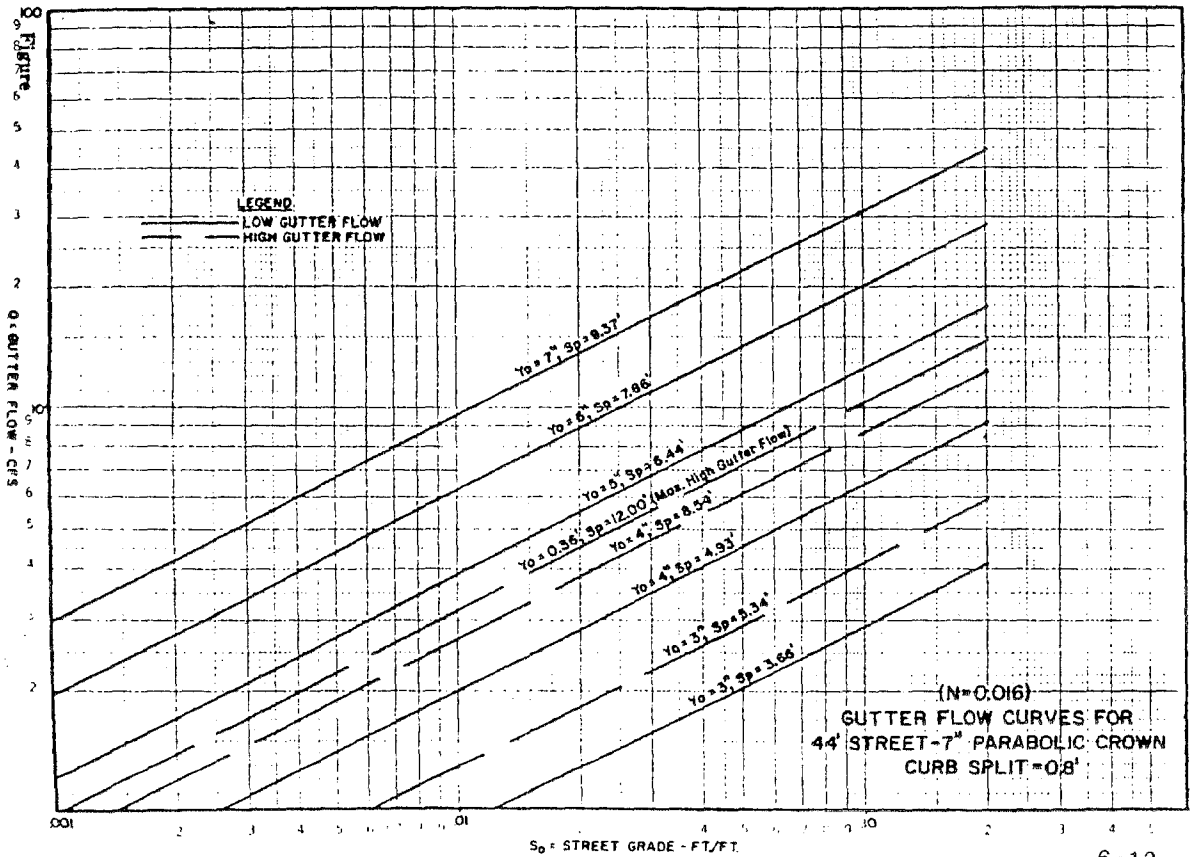

6-13

FIGURE

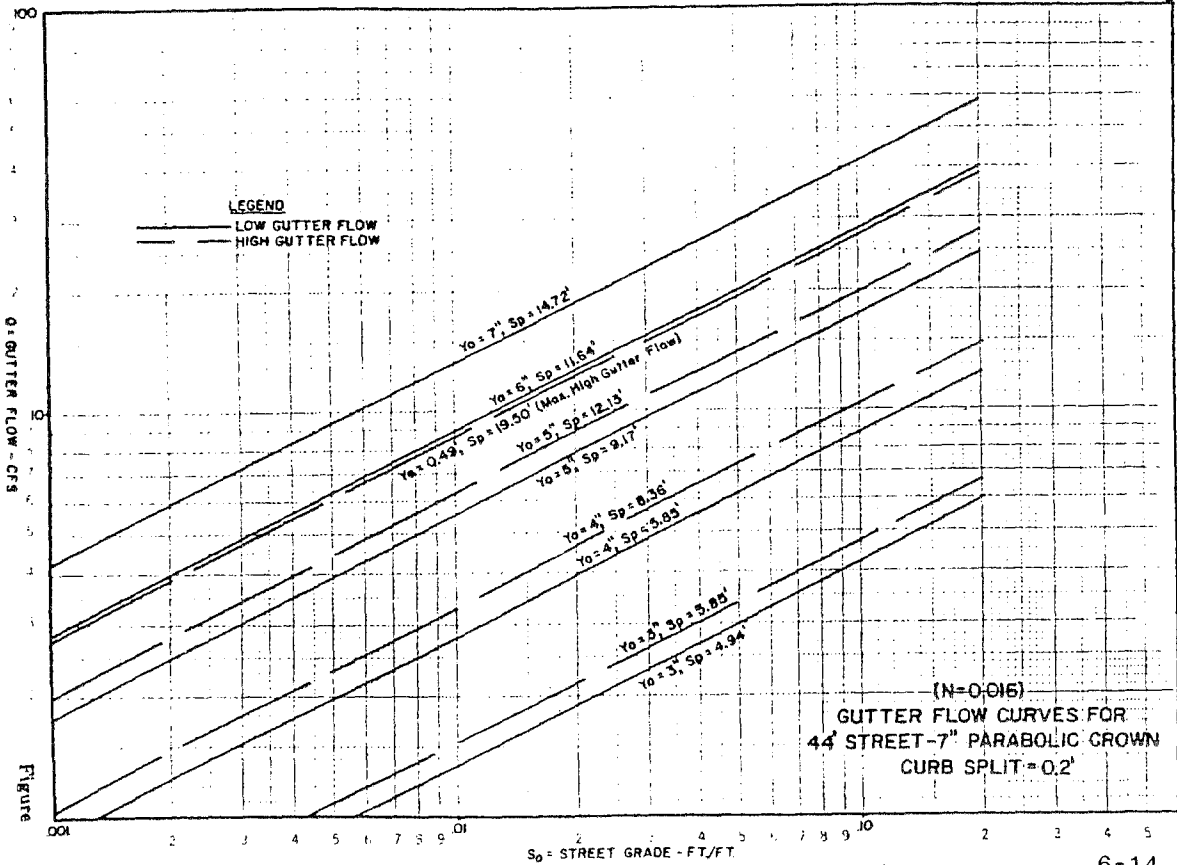

6-14
 FIGURE

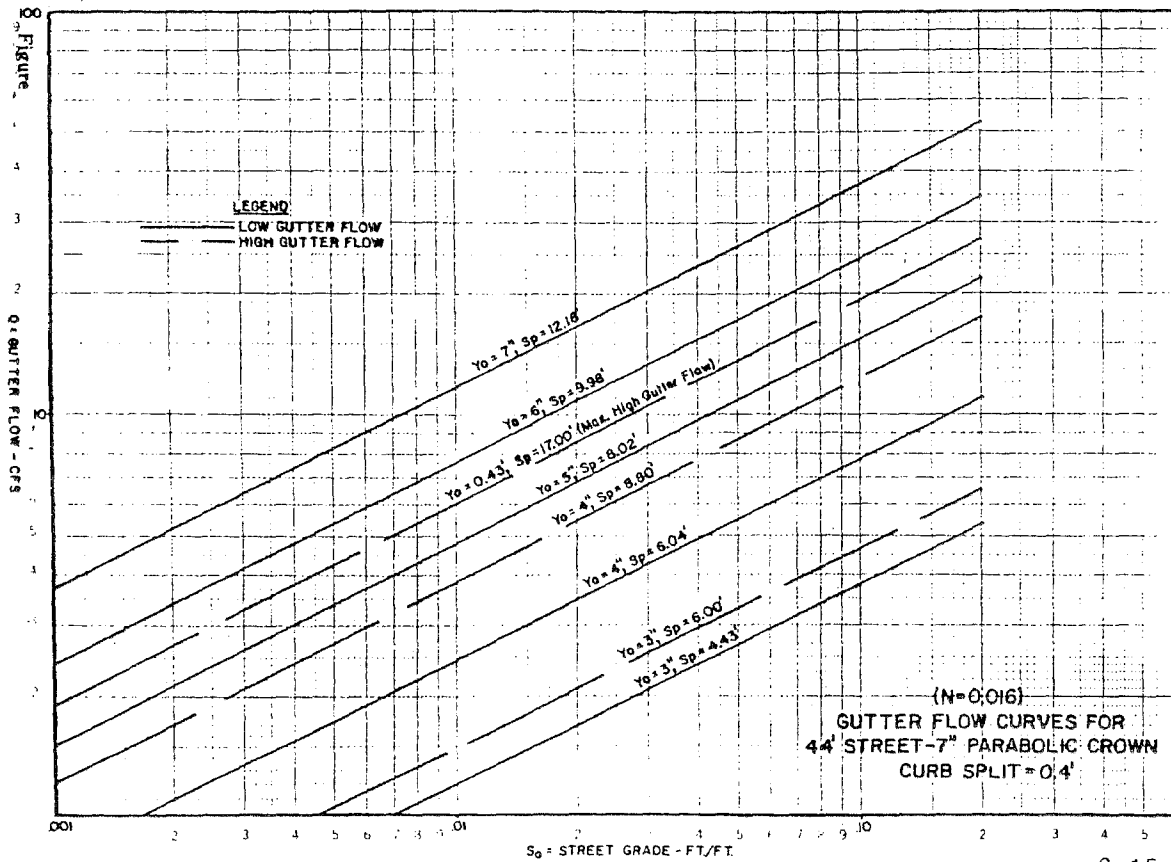

6-15
 FIGURE

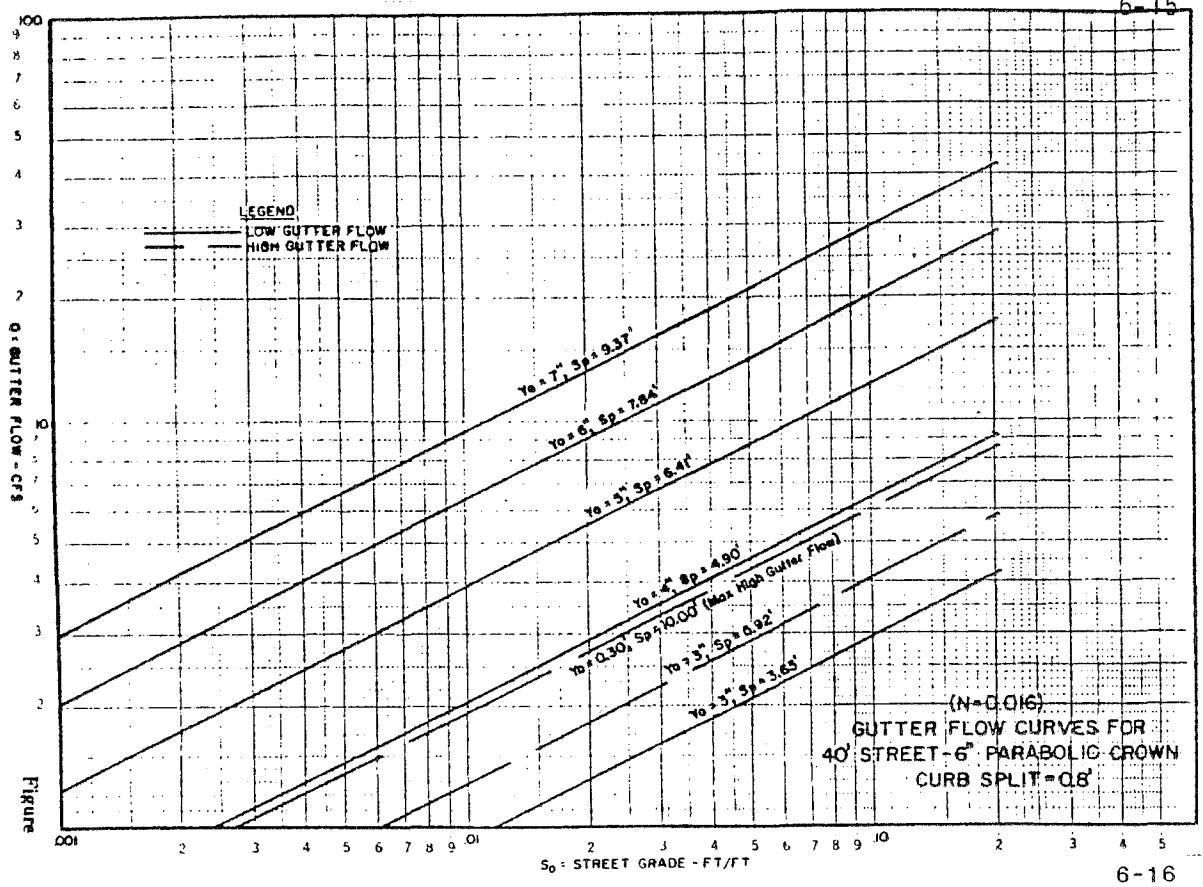

6-16
FIGURE

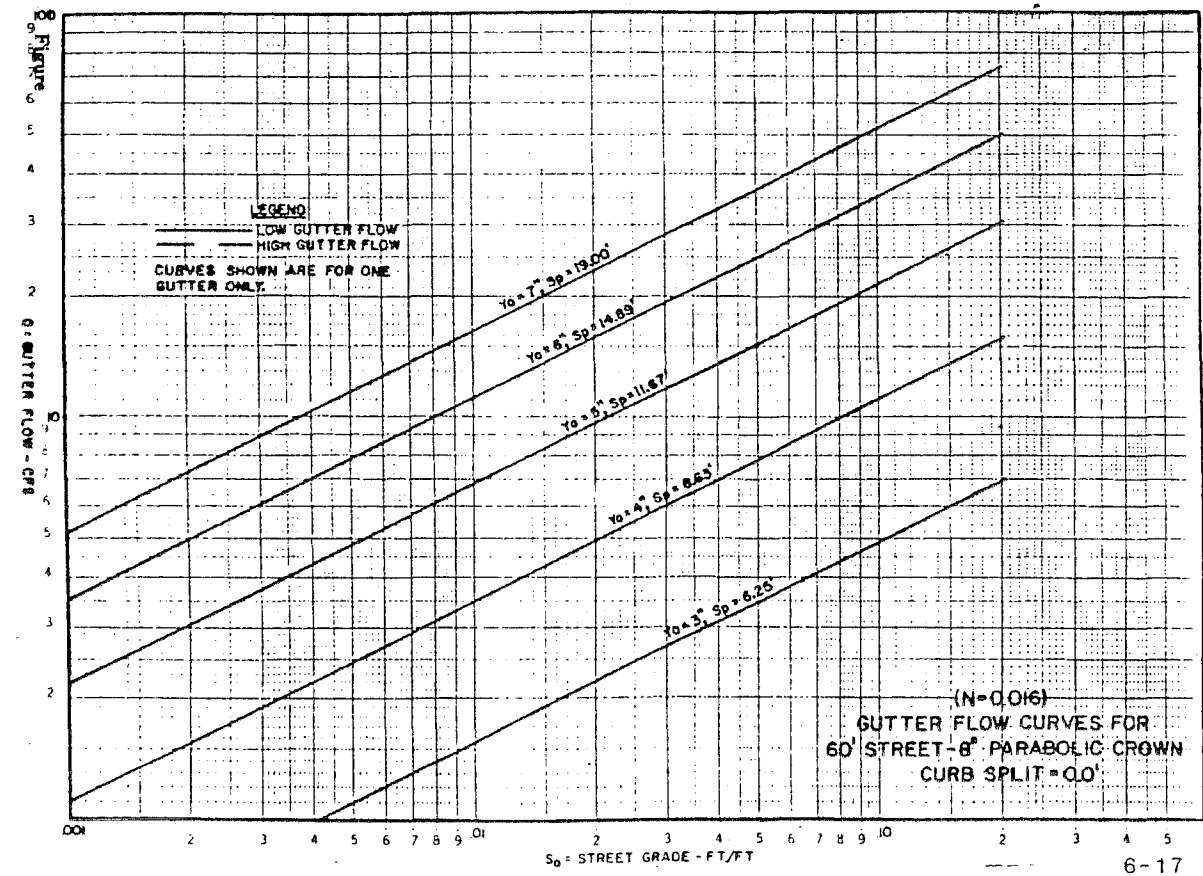

6-17
FIGURE

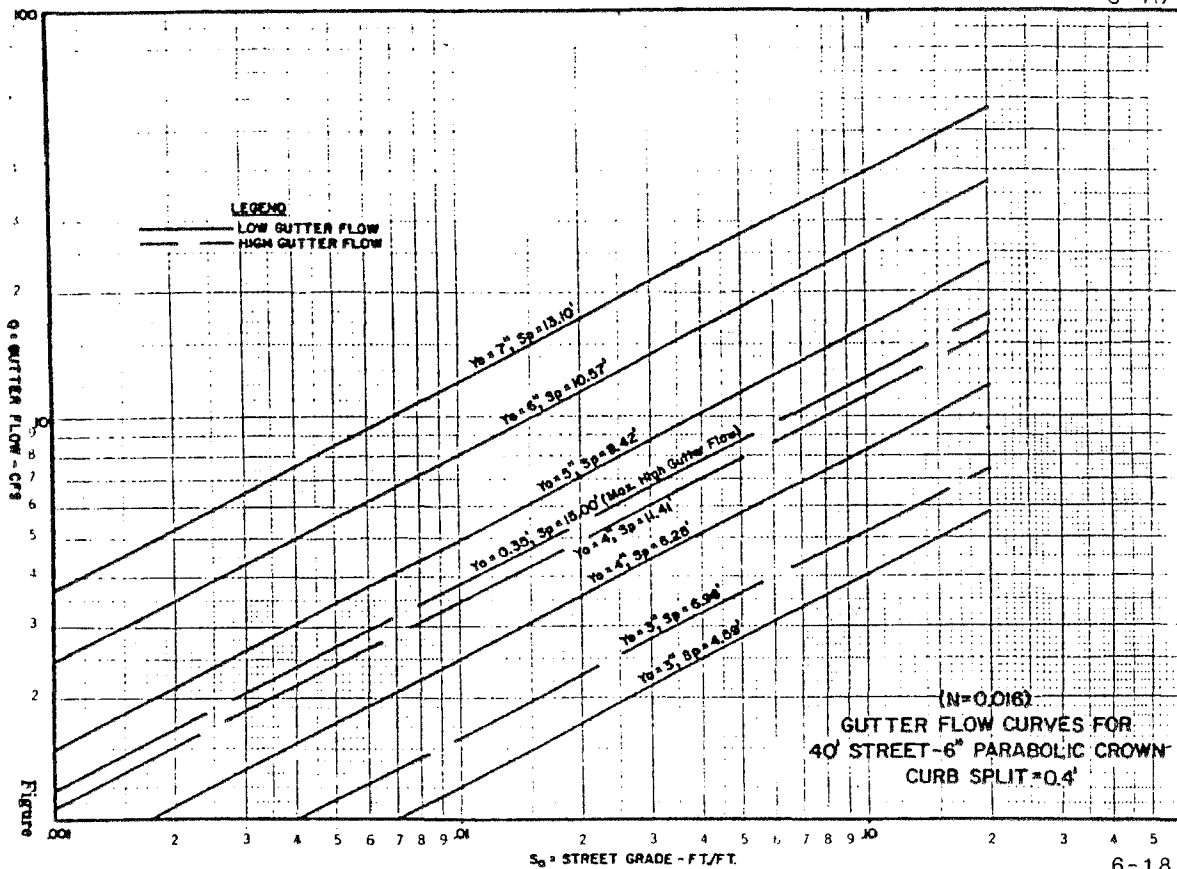

6-18

FIGURE

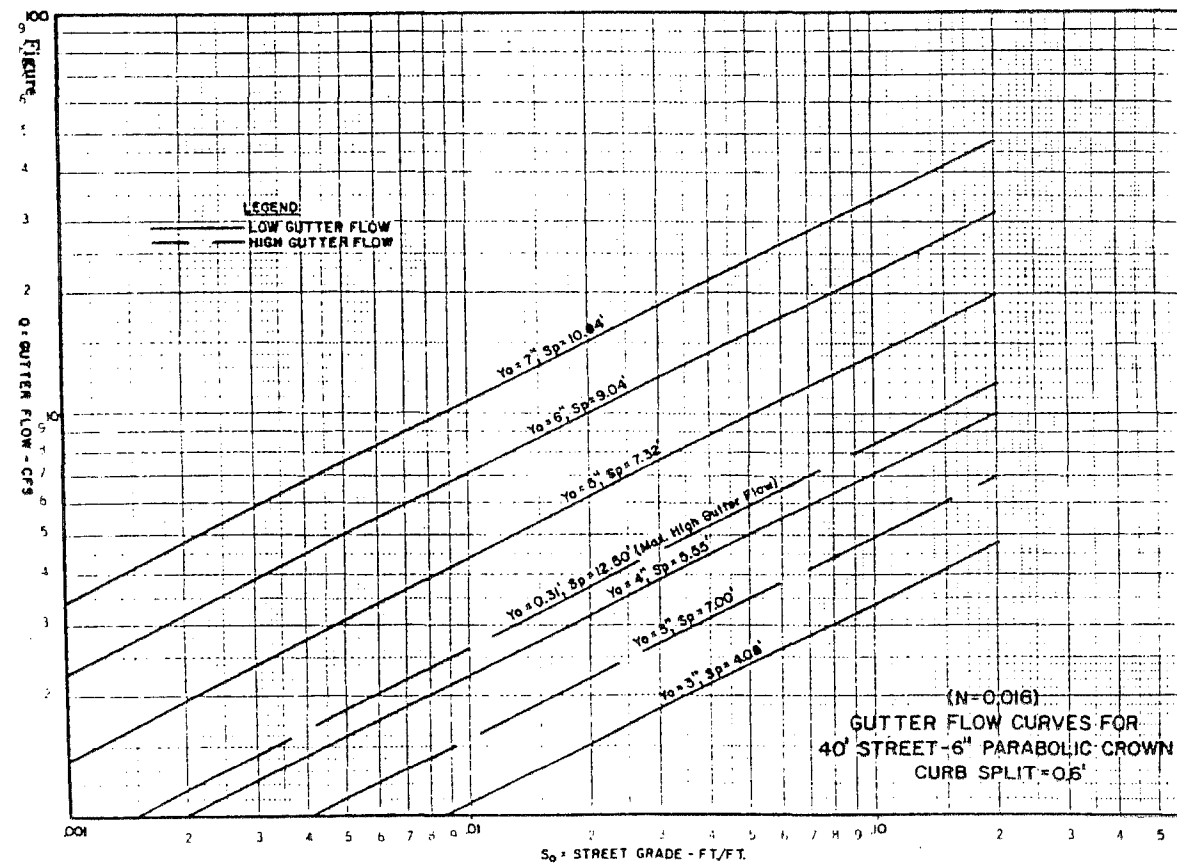

6-19

FIGURE

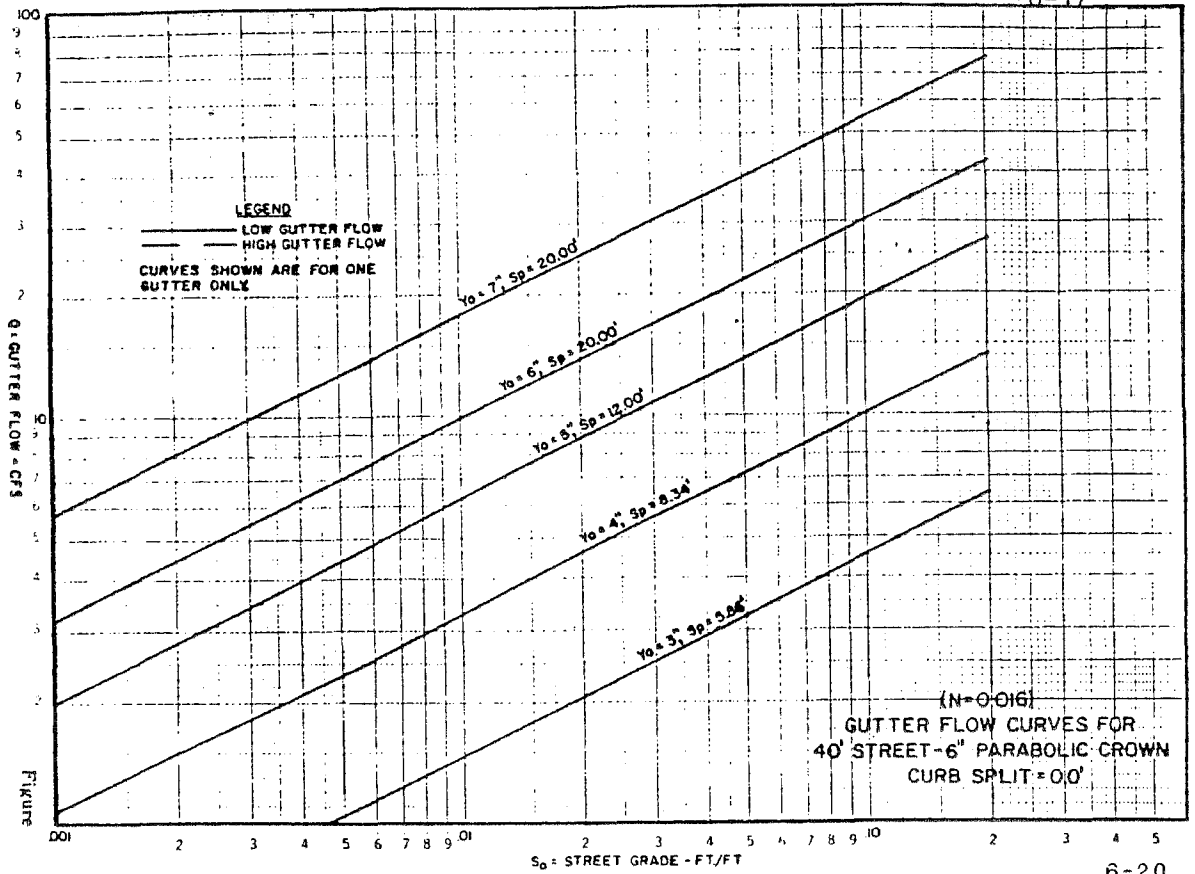

6-20
FIGURE

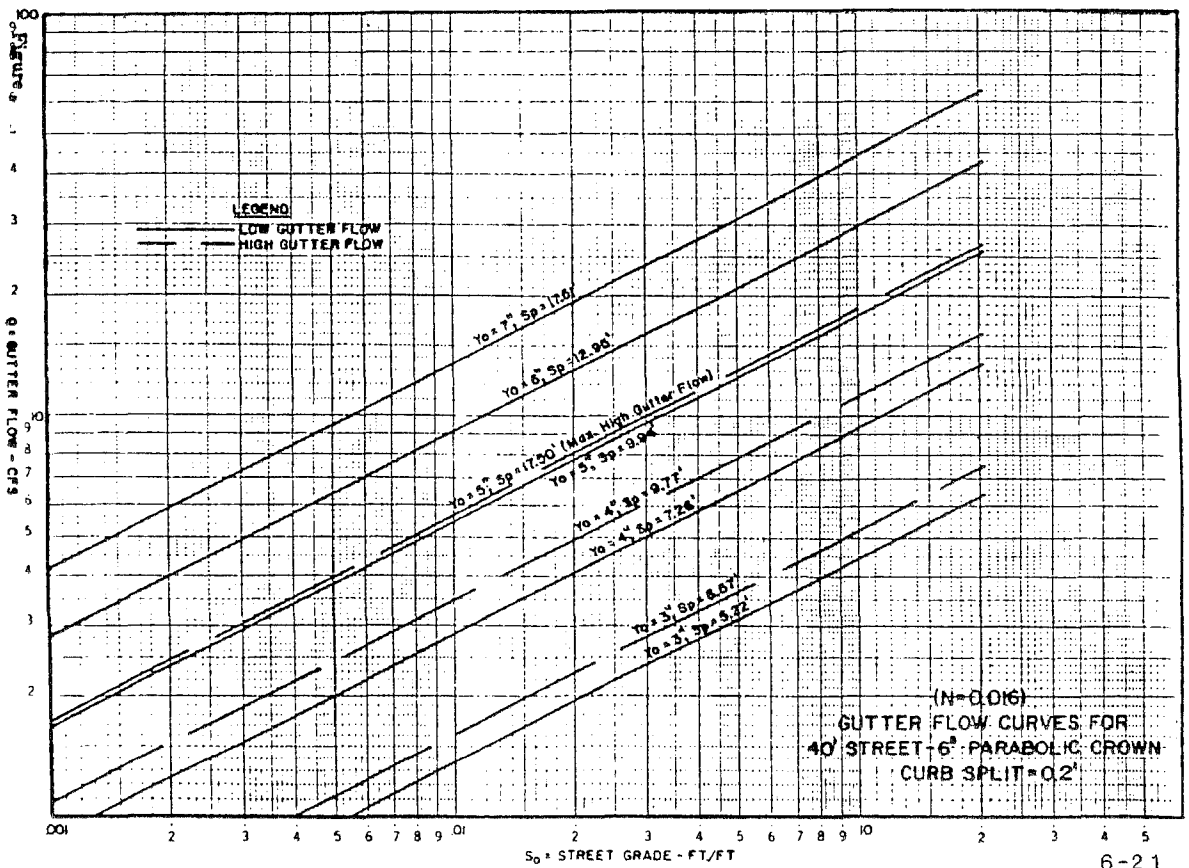

6-21
FIGURE

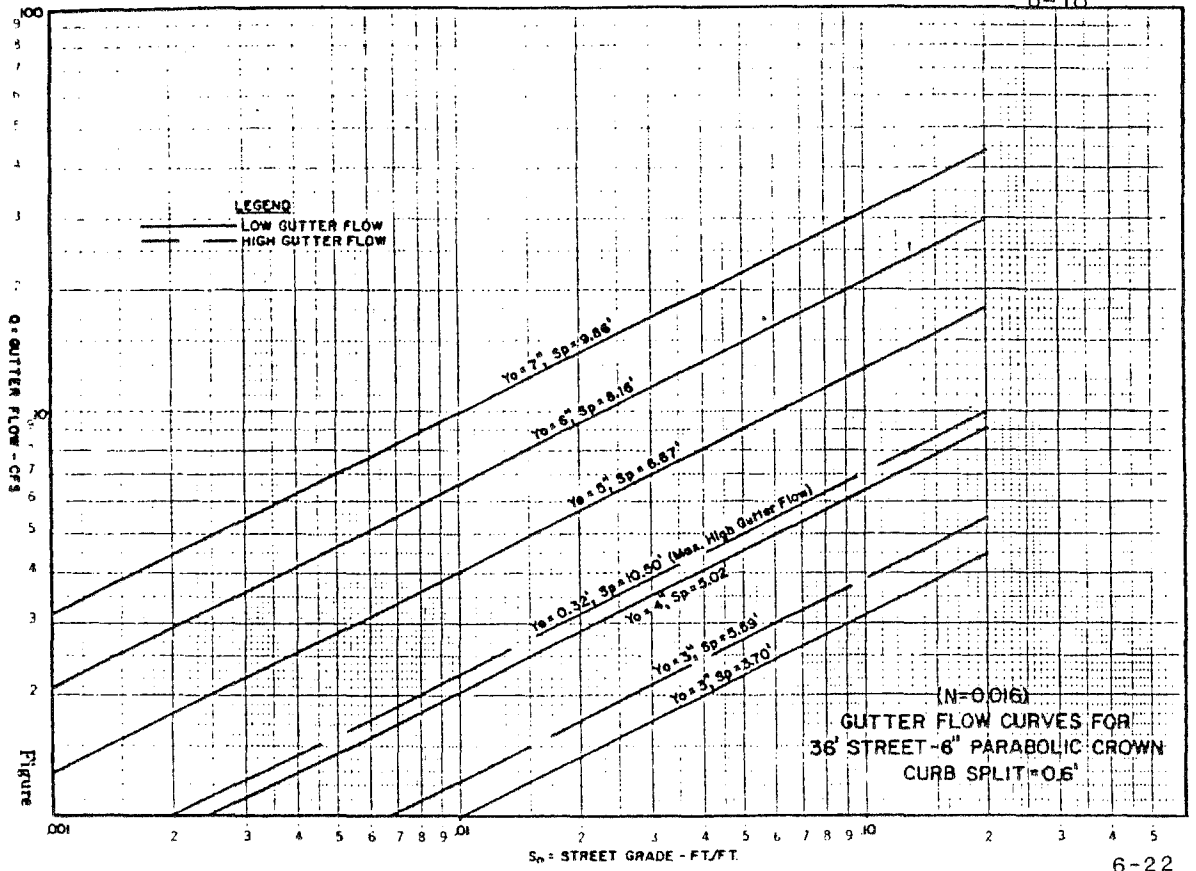

6-22

FIGURE

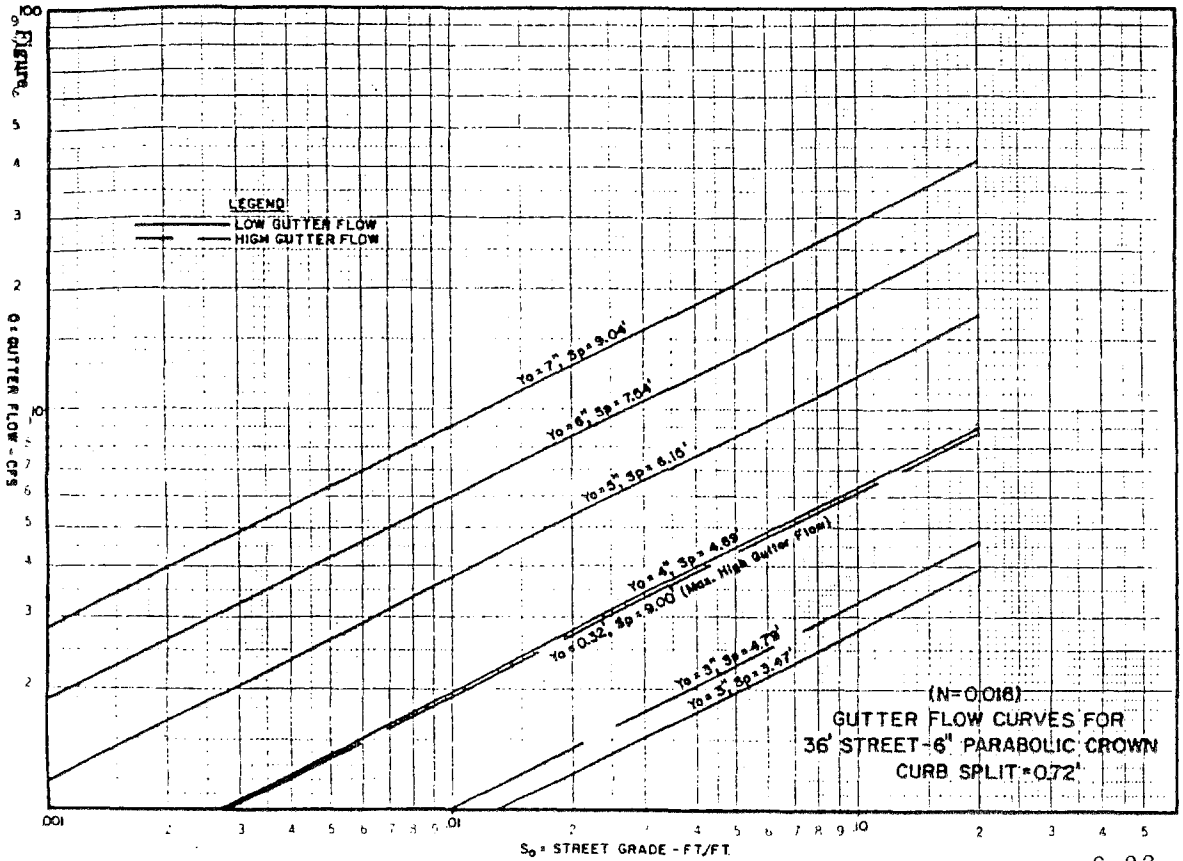

6-23

FIGURE

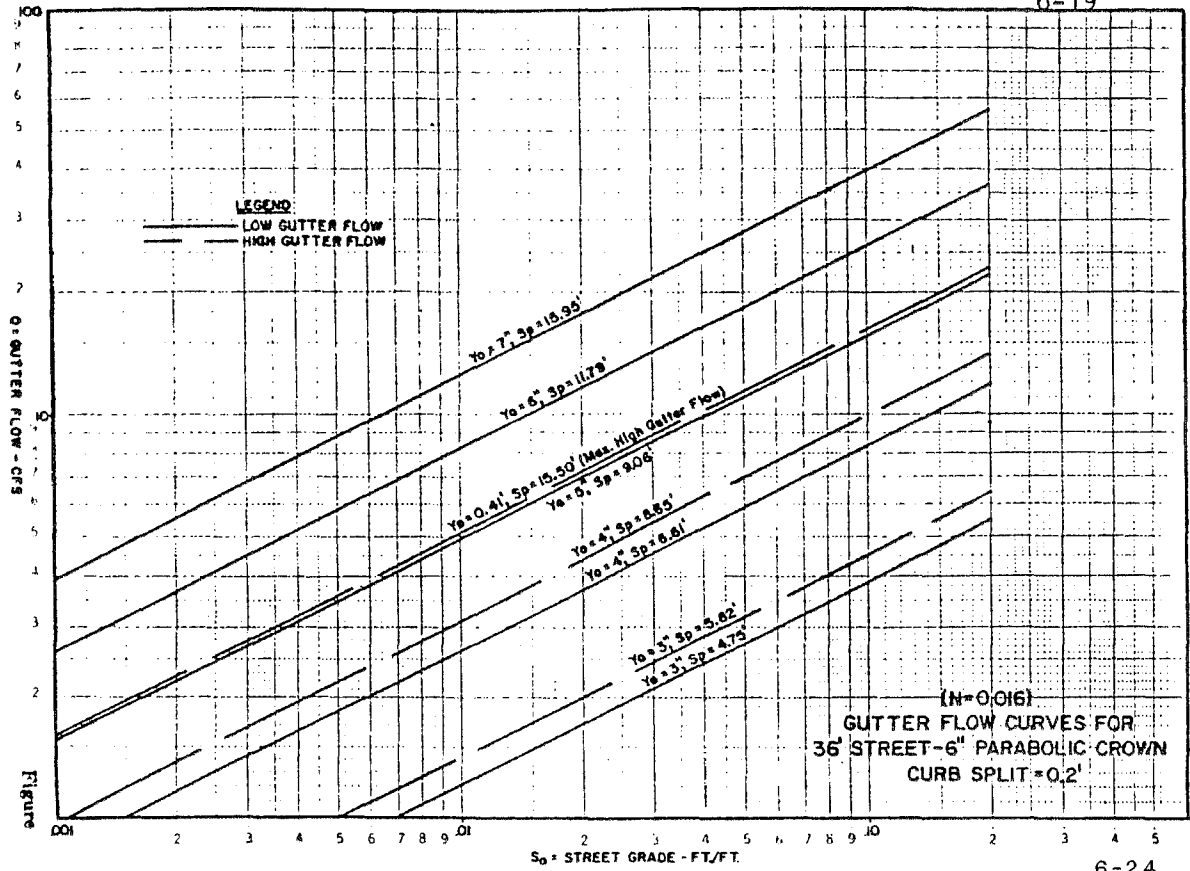

6-24

FIGURE

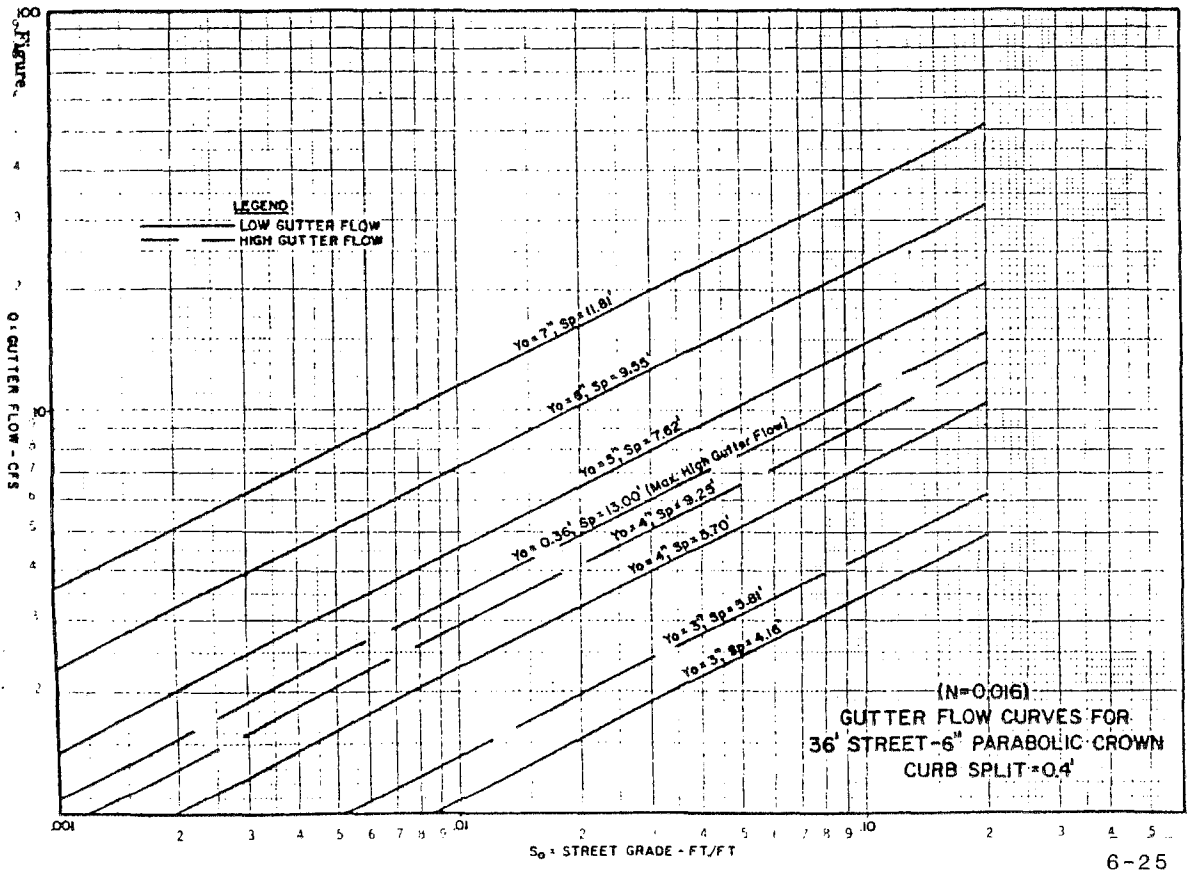

6-25

FIGURE

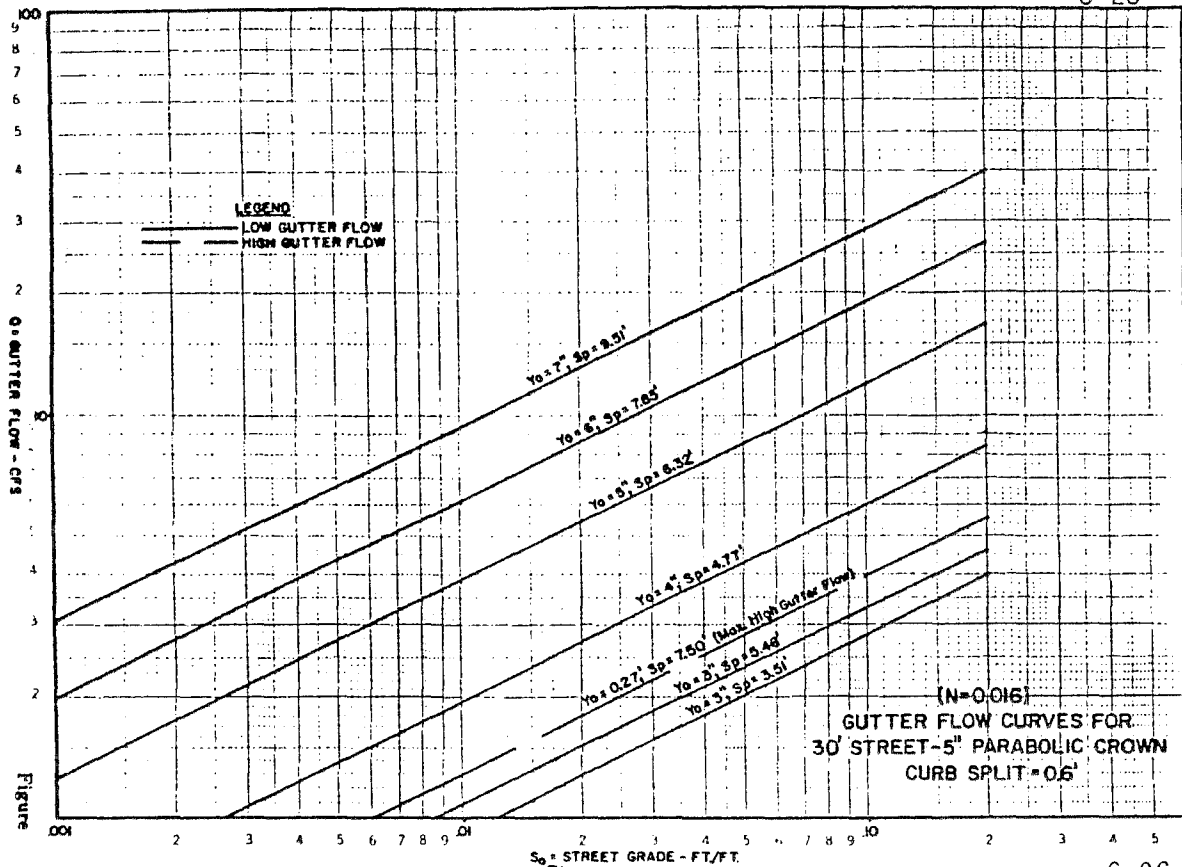

6-26

FIGURE

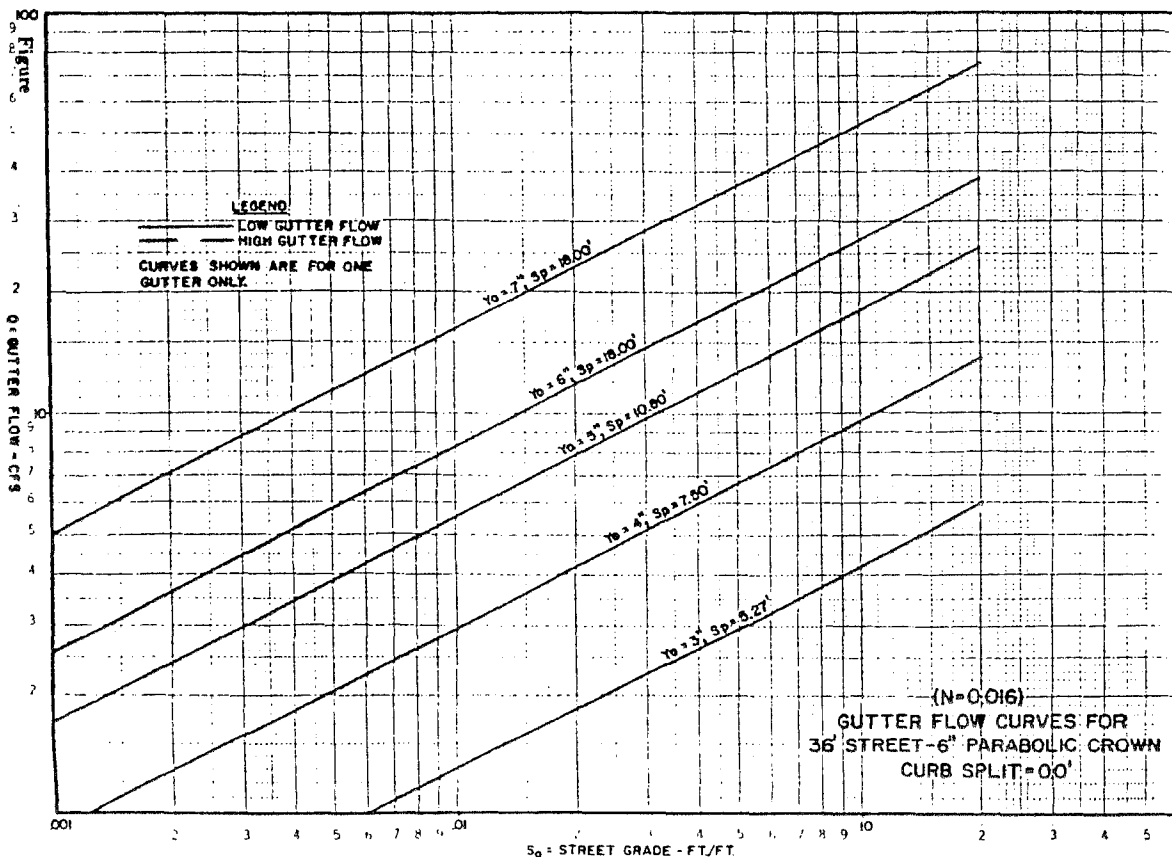

6-27

FIGURE

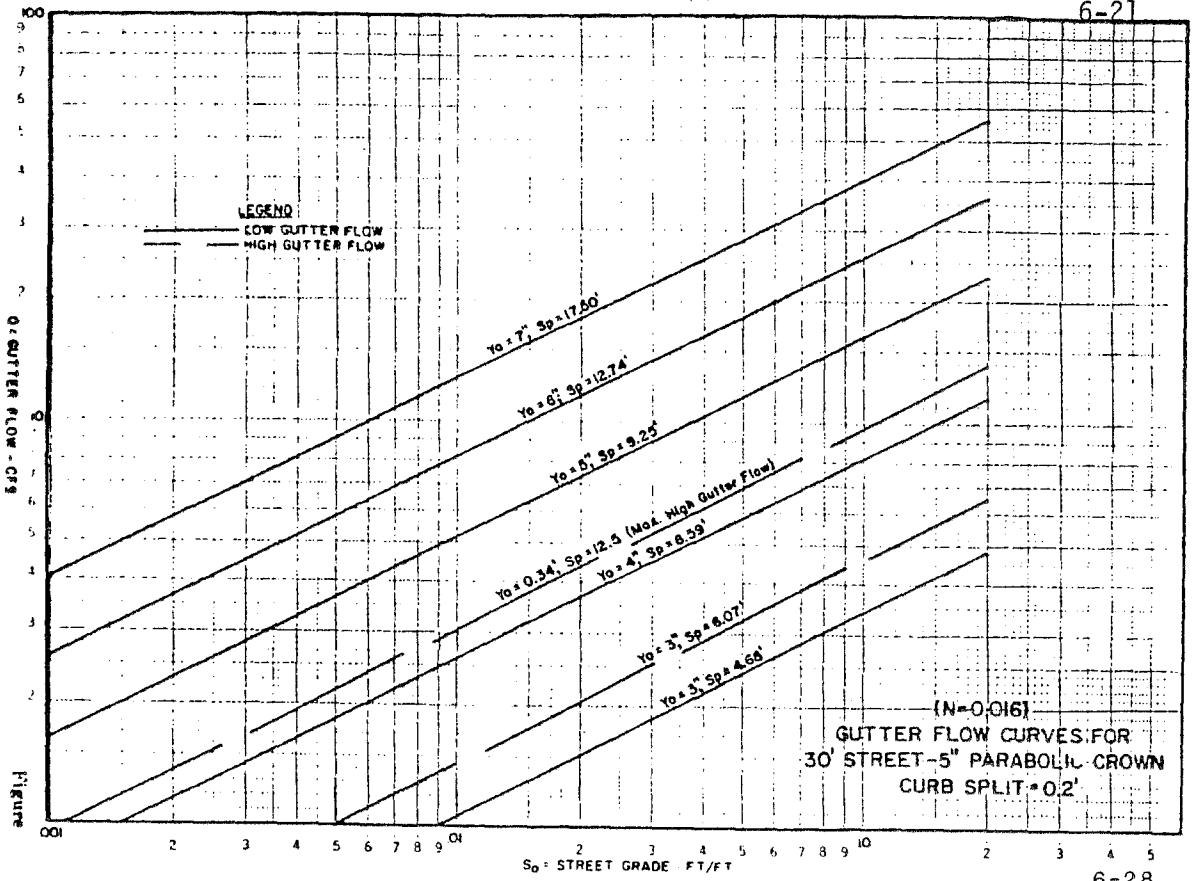

6-28

FIGURE

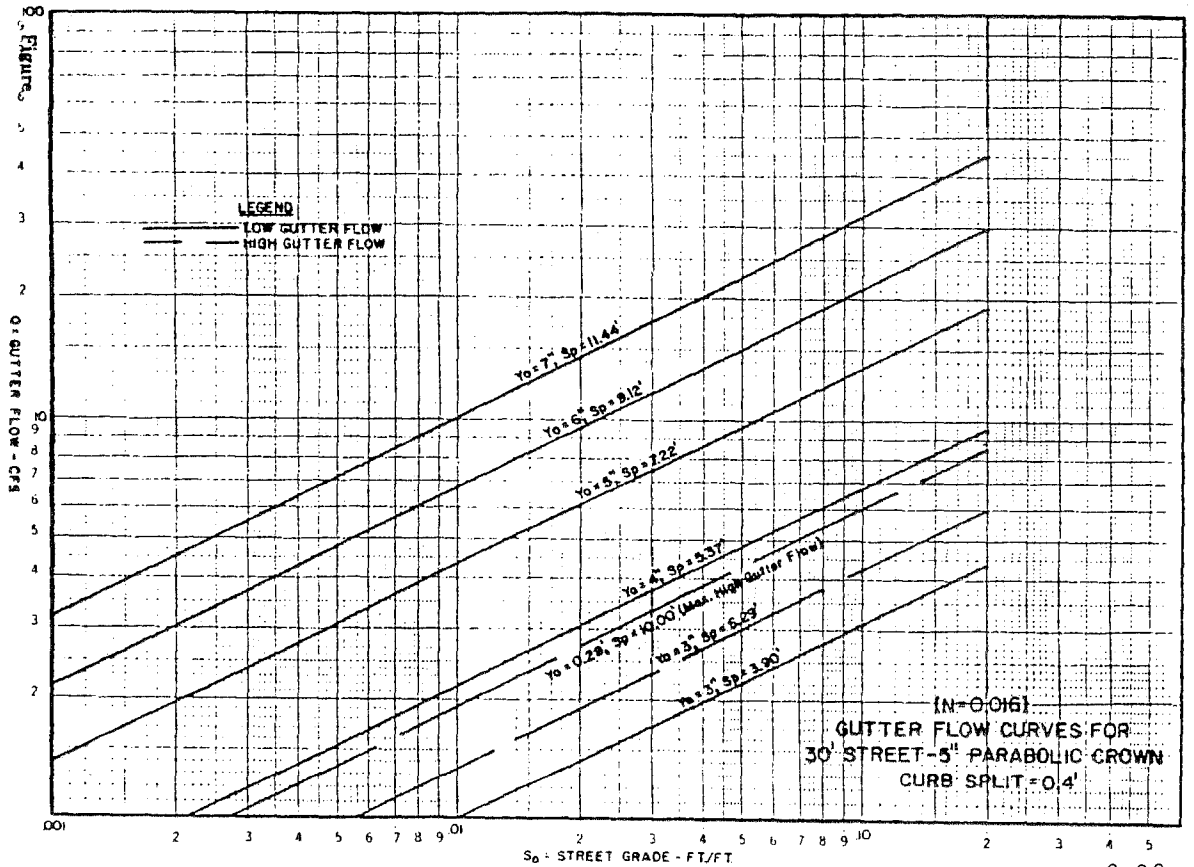

6-29

FIGURE

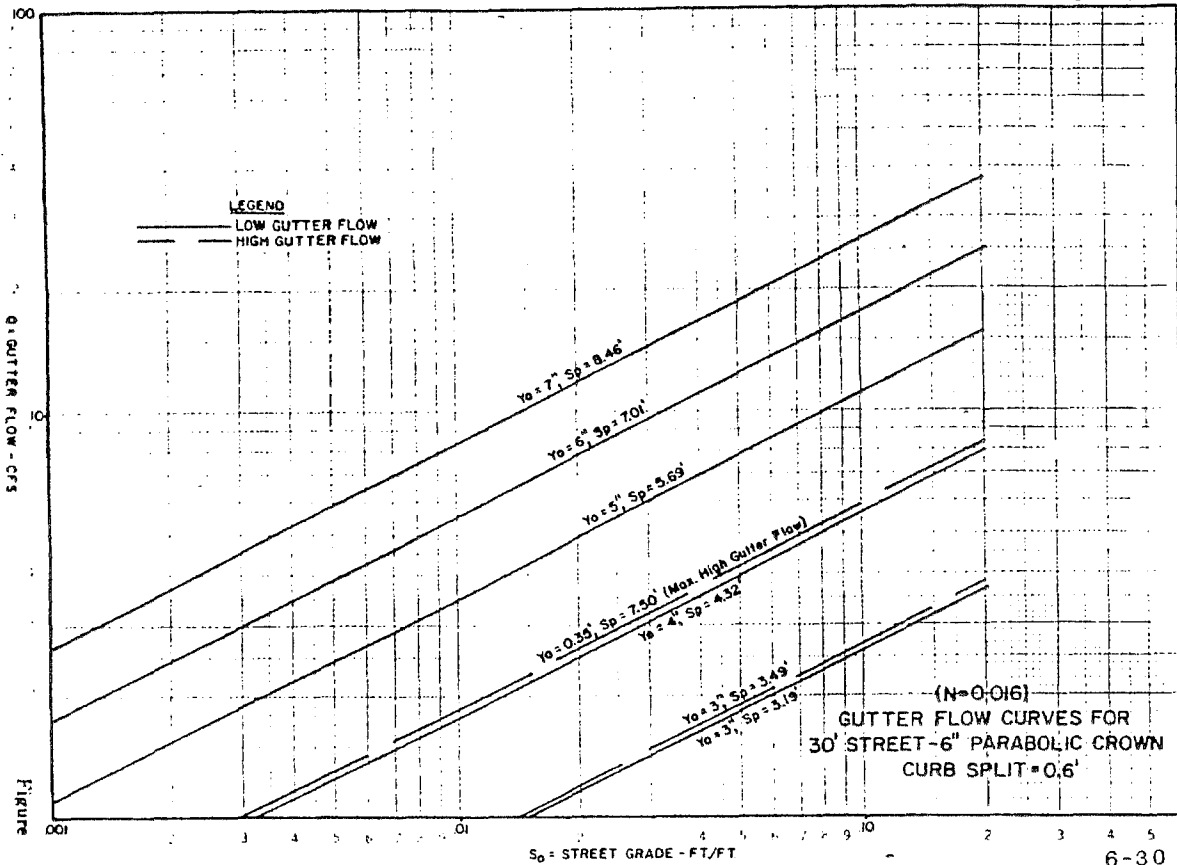

6-30

FIGURE

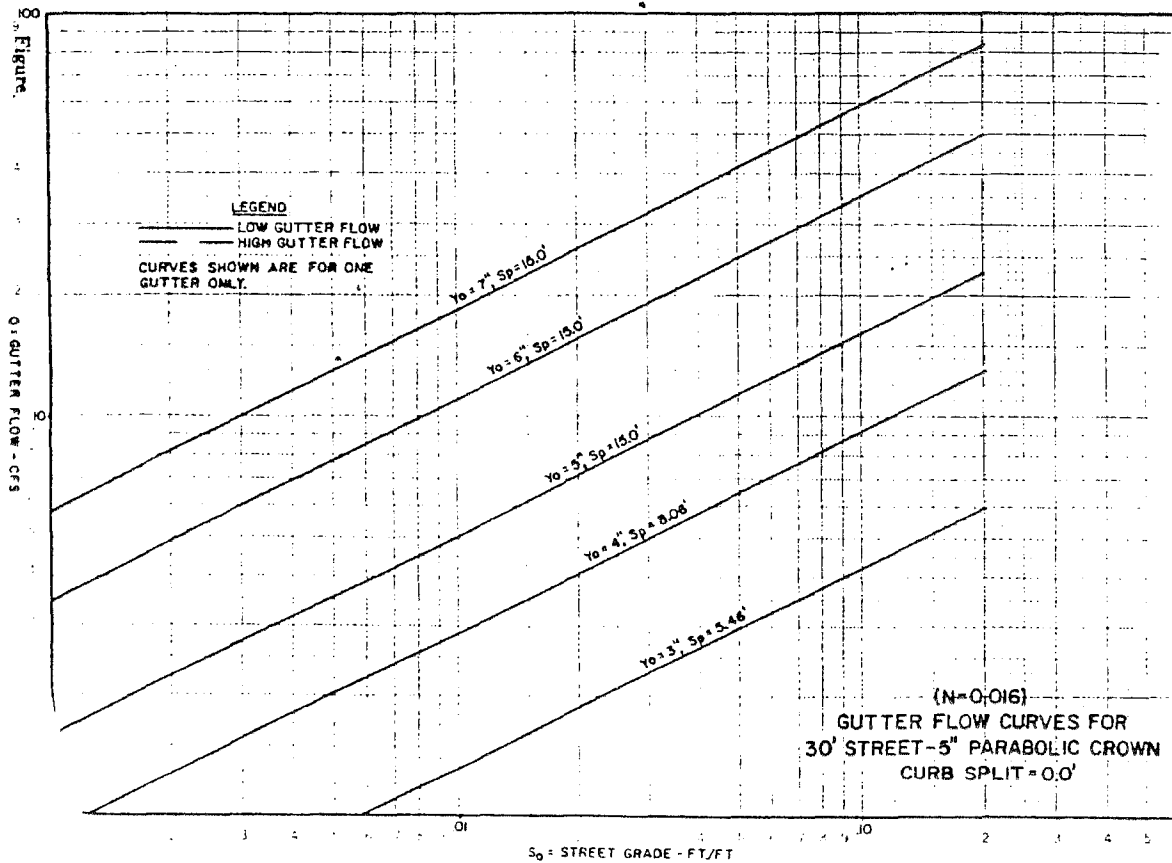

6-31

FIGURE

SECTION VII - STORM DRAIN INLETS

- 7.1 General
- 7.2 Classification
- 7.3 Inlets and Sumps
 - 7.3.1 Curb Opening Inlets and Drop Inlets
 - 7.3.2 Gate Inlets
 - 7.3.3 Combination Inlets
- 7.4 Inlets on Grade Without Gutter Depression
 - 7.4.1 Curb Opening Inlets
 - 7.4.2 Gate Inlets on Grade
 - 7.4.3 Combination Inlets on Grade
- 7.5 Inlets on Grade With Gutter Depression
 - 7.5.1 Curb Opening Inlets on Grade
 - 7.5.2 Gate Inlets in Grade
 - 7.5.3 Combination inlets on Grade
- 7.6 Use of Figures 7-10 and 7-11
- 7.7 Standard Curb-Opening Inlet Chart

SECTION VII - STORM DRAIN INLETS

7.1 GENERAL

The primary purpose of storm drain inlets is to intercept excess surface runoff and deposit it in a drainage system, thereby reducing the possibility of surface flooding.

The most common location for inlets is in streets which collect and channelize surface flow making it convenient to intercept. Because the primary purpose of streets is to carry vehicular traffic, inlets must be designed so as not to conflict with that purpose.

The following guidelines shall be used in the design of inlets to be located in streets:

1. Minimum transition for depressed inlets shall be 10 feet.
2. The use of inlets with a 5-inch depression is discouraged on collector, industrial and arterial streets unless the inlet is recessed.
3. When recessed inlets are used, they shall not interfere with the intended use of the sidewalk.
4. The capacity of a recessed inlet on grade shall be calculated as 0.75 of the capacity of a similar unrecessed inlet.
5. Design and location of inlets shall take into consideration pedestrian and bicycle traffic.
6. Inlet design and location must be compatible with the criteria established in Section III of this manual.

7.2 CLASSIFICATION

Inlets are classified into three major groups, mainly: inlets in sumps (Type A), inlets on grade without gutter depression (Type B), and inlets on grade with gutter depression (Type C). Each of the three major classes include several varieties. The following are presented herein and are likely to find reasonably wide use. (See Figures 7.1 - 7.7)

Inlets in Sumps

- | | |
|---------------------------------------|----------|
| 1. Curb opening | Type A-1 |
| 2. Grate | Type A-2 |
| 3. Combination (grate & curb opening) | Type A-3 |
| 4. Drop | Type A-4 |
| 5. Drop (grate covering) | Type A-5 |

Inlets on Grade Without Gutter Depression

- | | | |
|----|------------------------------------|----------|
| 1. | Curb Opening | Type B-1 |
| 2. | Grate | Type B-2 |
| 3. | Combination (grate & curb opening) | Type B-3 |

Inlets on Grade with Gutter Depression

- | | | |
|----|------------------------------------|----------|
| 1. | Curb Opening | Type C-1 |
| 2. | Grate | Type C-2 |
| 3. | Combination (grate & curb opening) | Type C-3 |

Recessed inlets are identified by the suffix (R, i.e.: A-1 (R)).

Public Works Department review of proposed drainage plan shall include examination of the supporting calculations. Computations must be submitted either as a part of the plans or on separate tabulations sheets convenient for review and use of a permanent record in order to speed review.

7.3 INLETS AND SUMPS

Inlets and sumps are inlets placed in low points of surface drainage to relieve ponding. Inlets with a 5-inch depression located in streets of less than one percent (1.0%) grade, shall be considered inlets in sumps. The capacity of inlets in sumps must be known in order to determine the depth and width of ponding for a given discharge. The charts in this section may be used in the design of any inlet in a sump, regardless of its depth of depression.

7.3.1 CURB OPENING INLETS AND DROP INLETS

General. Unsubmerged curb opening inlets (Type A-1) and drop inlets (Type A-4) in a sump where low points are considered to function as rectangular weirs with a coefficient of discharge of 3.0. Their capacity shall be based on the following equation:

$$Q = 3.0 y^3 L$$

Q = capacity in CFS of curb opening inlet or
capacity in CFS of drop inlet

y = head at the inlet in feet

L = length of opening through which water enters
the inlet.

Figure 7-8 provides for direct solution of the above equation. Curb opening inlets and drop inlets in sumps have

a tendency to collect debris at their entrances. For this reason, the calculated inlet capacity shall be reduced by 10 percent to allow for clogging.

7.3.2 GRATE INLETS

General. A grate inlet, Type A-2 or A-5 in a sump can be considered an orifice with the coefficient of discharge of 0.6. The capacity shall be based on the following equation:

$$Q = 4.82 A_g y^{1/2}$$

Q = capacity in CFS

A_g = area of clear opening in square feet

y = depth at inlet or head at sump in feet

The curve shown in Figure 7-9 provides for direct solution of the above equation.

Grate inlets and sumps have a tendency to clog when flows carry debris such as leaves and papers. For this reason, the calculated inlet capacity of a grate inlet shall be reduced by 25 percent to allow for clogging.

7.3.3 COMBINATION INLETS (TYPE A-3)

The capacity of a combined inlet Type A-3 consisting of a grate and curb opening inlet in a sump shall be considered to be the sum of the capacities obtained from Figures 7-8 and 7-9. When the capacity of the gutter is not exceeded, the grate inlet accepts the major portion of the flow. Under severe flooding conditions, however, the curb inlet will accept most of the flow since its capacity varies with $y^{1.5}$. Whereas the capacity of the grate varies as $y^{0.5}$.

Combination inlets and sumps have a tendency to clog and collect debris at their entrance. For this reason, the calculated inlet capacity shall be reduced by 20 percent to allow for this clogging.

7.4 INLETS ON GRADE WITHOUT GUTTER DEPRESSION

7.4.1 CURB OPENING INLETS (UNDEPRESSED: TYPE B-1)

General. The capacity of the curb inlet, like any weir depends upon the head and length of the overfall. In the case of an undepressed curb opening inlet, the head at the upstream end of the opening is the depth of flow in the gutter. In streets where grades are greater than 1 percent the velocities are high and the depths of flow are usually

small, as there is little time to develop cross flow into the curb openings; therefore, undepressed inlets are inefficient when used in streets of appreciable slope, but may be used satisfactorily where the grade is low and the crown slope high or the gutter channelized. Undepressed inlets do not interfere with traffic and usually are not susceptible to clogging. Inlets on grade should be designed and spaced so that 5 to 15 percent of gutter flow reaching each inlet will carry over to the next inlet downstream, provided the water carry-over does not inconvenience pedestrian or vehicular traffic.

The capacity of an undepressed inlet shall be determined by use of Figures 7-10 and 7-11. An example of the use of Figures 7-10 and 7-11 is included at the end of this section.

7.4.2 GRATE INLETS ON GRADE (UNDEPRESSED; TYPE B-2)

General. Undepressed grate inlets on grade have a greater hydraulic capacity than curb inlets of the same length so long as they remain unclogged. Undepressed inlets on grade are inefficient in comparison to grate inlets in sumps. Their capacity shall be the capacity determined from Figure 7-9 reduced by 15 percent. Grate inlets should be so designed and spaced so that 5 to 15 percent of the gutter flow reaching each inlet will carry over to the next downstream inlet, provided the carry-over does not inconvenience pedestrian or vehicular traffic.

Grates shall be certified by the manufacturer as bicycle-safe. For flows on streets with grades less than 1 percent, little or no splashing occurs regardless of the direction of the bars.

Vane grate inlets are the recommended grates for best hydraulic capacity and should be the first grate type considered on any project. The calculated capacity for a grate inlet shall be reduced by 25 percent to allow for clogging.

7.4.3 COMBINATION INLETS ON GRADE (UNDEPRESSED: TYPE B-3)

General. Undepressed combination (curb opening and grate) inlets on grade have greater hydraulic capacity than curb inlets or grate inlets of the same length. Generally speaking, combination inlets are the most efficient of the three types of undepressed inlets presented in this manual. Grates with bars parallel to the curb should always be used. The basic difference between a combination inlet and a grate inlet is that the curb opening receives the carry over flow that falls between the curb and the grate. The recommended grate of this type is Neenah R-3065-L curb inlet frame, grate and curb box or equivalent.

The capacity of a Type B-3 inlet shall be considered to be 90 percent of the sum of the capacities as determined for a Type B-1 and Type B-2 inlet (allowing reduction due to clogging).

7.5 INLETS ON GRADE WITH GUTTER DEPRESSION

7.5.1 CURB OPENING INLETS ON GRADE (DEPRESSED; TYPE C-1)

General. The depression of the gutter at a curb opening inlet below the normal level of the gutter increases the cross-flow toward the opening, thereby increasing the inlet capacity. Also, the downstream transition out of the depression causes backwater which further increases the amount of water captured. Depressed inlets should be used on continuous grades that exceed 1 percent except that their use in traffic lanes shall conform with the requirements of Section VI of this manual.

The depression depth, width, length and shape all have significant effects on the capacity of an inlet. Reference to Section VI of this manual must be made for permissible gutter depressions.

The capacity of a depressed curb inlet will be determined by the use of Figures 7-10 and 7-11.

7.5.2 GRATE INLETS ON GRADE (DEPRESSED; TYPE C-2)

General. The depression of the gutter at a grate inlet decreases the flow past the outside of a grate. The effect is the same as that when a curb inlet is depressed, mainly the cross slope of the street directs the outer portion of flow toward the grate.

The bar arrangements for depressed grate inlets on streets with grades greater than 1 percent greatly affect the efficiency of the inlet. Grates with longitudinal bars eliminate splash which causes the water to jump and ride over the cross bar grates, and it is recommended that grates have a minimum of transverse cross bars for strength and spacing only.

For low flows or for streets with grades less than 1 percent, little or no splashing occurs regardless of the direction of the bars. However, as the flow or street grade increases, the grate with longitudinal bars becomes progressively superior to the cross bar grate. A few small rounded cross bars, installed at the bottom of the longitudinal bars as stiffeners or a safety stop for bicycle wheels do not materially affect the hydraulic capacity of longitudinal bar grates. A bicycle safe grate must be used.

The capacity of a Type C-2 inlet on grades less than 1 percent shall be the capacity determined from Figure 7-9. The capacity of C-2 inlets on grades greater than 1 percent shall be 90 percent of the capacity as determined from Figure 7-9.

Grate inlets and depressions have a tendency to clog when gutter flow carry debris such as leaves and papers. For this reason, the calculated inlet capacity of a grate inlet shall be reduced by 25 percent to allow for clogging.

7.5.3 COMBINATION INLETS ON GRADE (DEPRESSED; TYPE C-3)

General. Depressed combination inlets (curb opening + grate) have greater hydraulic capacity than curb opening inlets or grate inlets of the same length. Generally speaking, combination inlets are the most efficient of the three types of depressed inlets presented in this manual. The basic difference between a combination inlet and a grate inlet is that the curb opening receives the carry-over flow that passes between curb and the grate. A bicycle safe grate must be used. Vane grates are the recommended grate. The recommended grate of this type is Neenah R-3065-L curb inlet frame, grate and curb box or equivalent.

The depression depth, width, length and shape all have significant effect on the capacity of any inlet. Reference to Section VI of this manual must be made for permissible gutter depressions.

The capacity of a C-3 inlet will be considered to be 90 percent of the some of the capacity of a C-1 inlet and a C-2 inlet (allowing for reduction due to clogging).

7.6 USE OF FIGURES 7-10 AND 7-11

Example 1

Given: Street width = 30 feet

Cross slope = 0 feet

Street grade = 1.0 percent

Q_a in 1 gutter = 8 CFS

Determine: Capacity of a 10' curb inlet with 2.5" depression

Step 1 - From Figure in Section VI, depth of flow in gutter is $Y = 6.2''$ or $0.51''$

Step 2 - Enter Figure 7-10 with $Y = 0.51''$ and $A = 2.5''$ and find corresponding $Q_a/L_a = 0.56$

Step 3 - Compute L_a ; $L_a = 8/0.56 = 14.3$

Step 4 - Compute $L/L_a = 10/14.3 = 0.70$

Step 5 - Enter Figures 7-11 with $L/A = 0.70$ and $A/Y = 0.41$ and find corresponding $Q/Q_a = 8.86$

Step 6 - Determine Q from $Q/Q_a = 0.86$

$Q = 8.6 (8) = 6.9$ CFS

Example 2

Given: Street width = 44'

Cross slope = 0.4'

Street grade = 0.6%

Q_a in low gutter = 8 CFS

Determine: Length of undepressed curb inlet required to intercept 80% of gutter flow ($Q = 6.4$)

Step 1 - From Figure in Section III, depth of flow in gutter (y) = 675" or 0.56 feet

Step 2 - Entering Figure 7-10 with $y = 0.56$, and $a = 0$ from corresponding $Q_a/L_a = 0.28$

Step 3 - Determine L_a ; $L_a = 8/0.28 = 28$

Step 4 - Entering Figure 7-11 with $Q/Q_a = 0.8$ and $a/y = 0$, find corresponding $L/L_a = 0.48$

Step 5 - Compute L from $L/L_a = 0.48$, $L = 28.6$
(0.48) = 13.7' Use $L = 15'$

Step 6 - Compute $L/L_a = 15/28 = 0.54$

Step 7 - Enter Figure 7-11 with $L/L_a = 0.54$ and $a/y = 0$, find corresponding $Q/Q_a = 0.85$

Step 8 - Compute Q from $Q/Q_a = 0.85$

$Q = 8 (0.85) = 6.8$ CFS

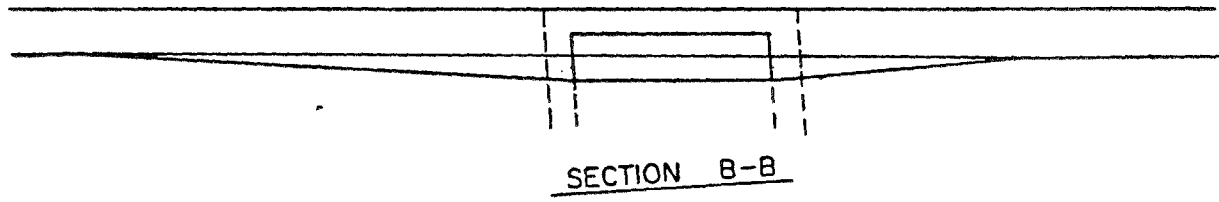
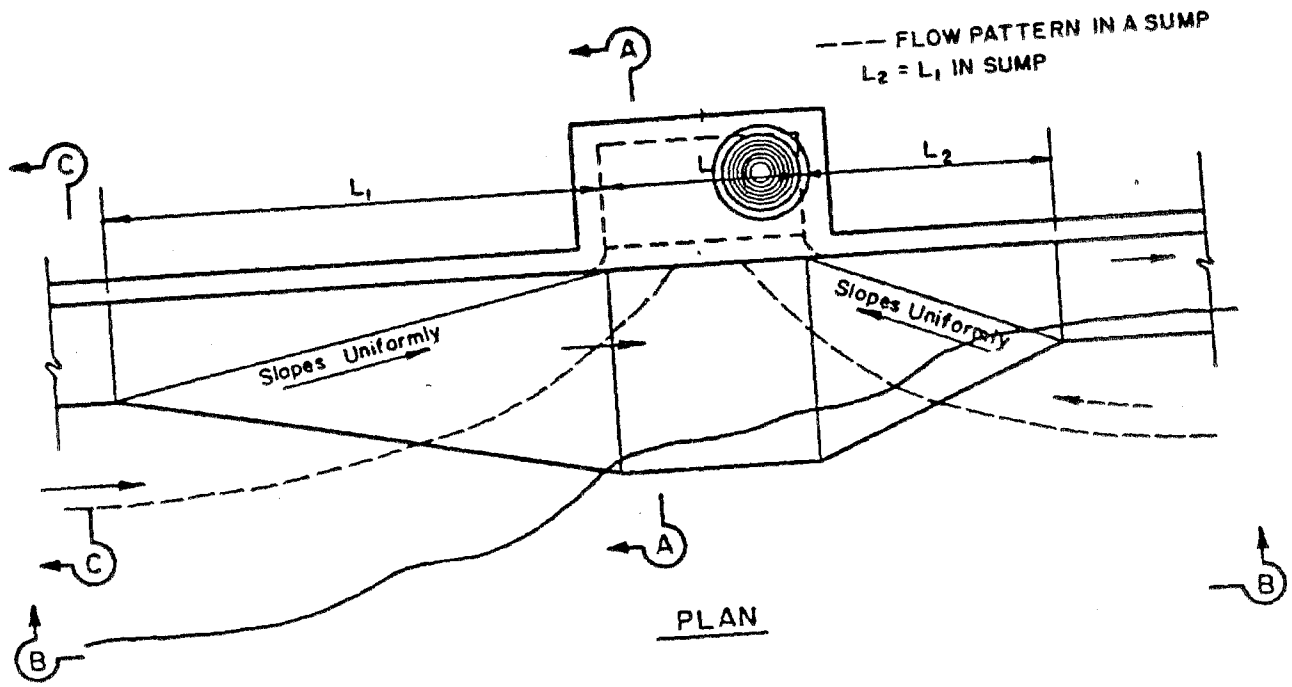

$$E = y_0 + \frac{v_0^2}{2g} + a$$

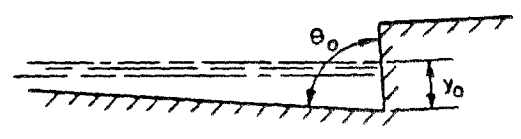
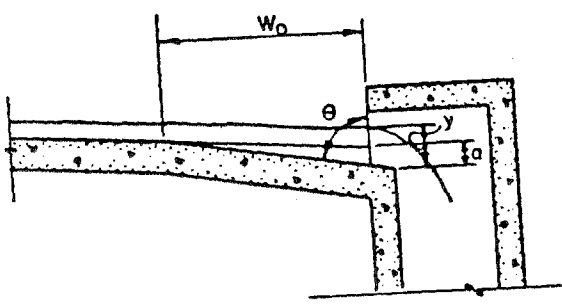

DEPRESSED CURB-OPENING INLET
 TYPE A-1 & C-1

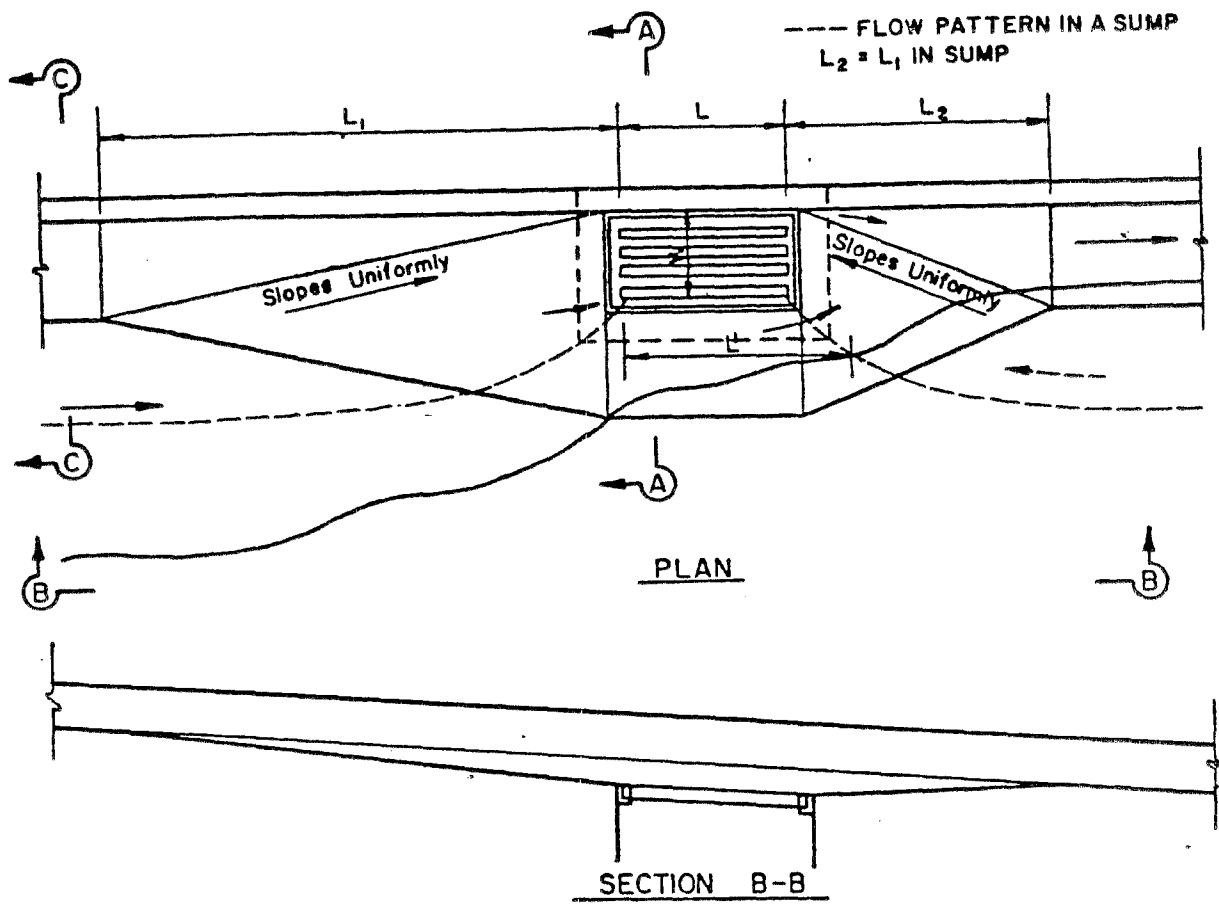

$$E = y_0 + \frac{v_0^2}{2g} + a$$

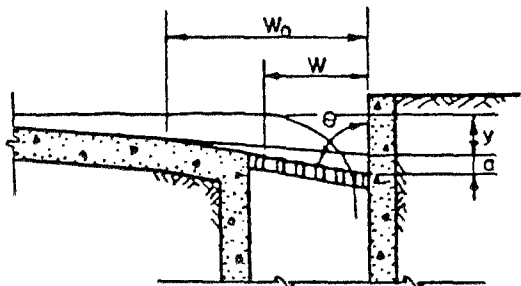

SECTION A-A



SECTION C-C

DEPRESSED GRATE INLET
TYPE A-2 & C-2

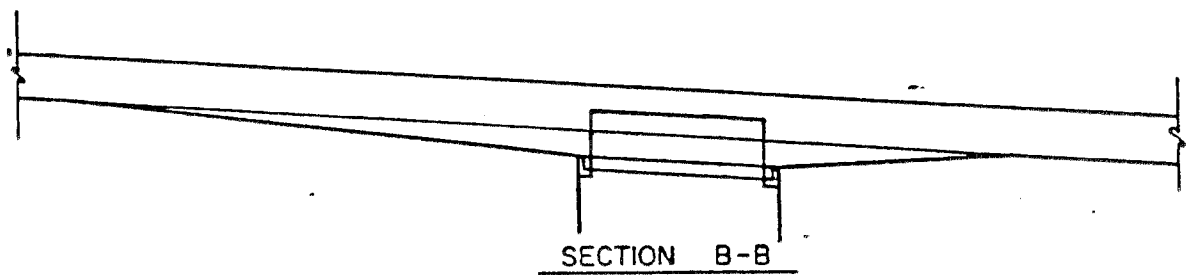
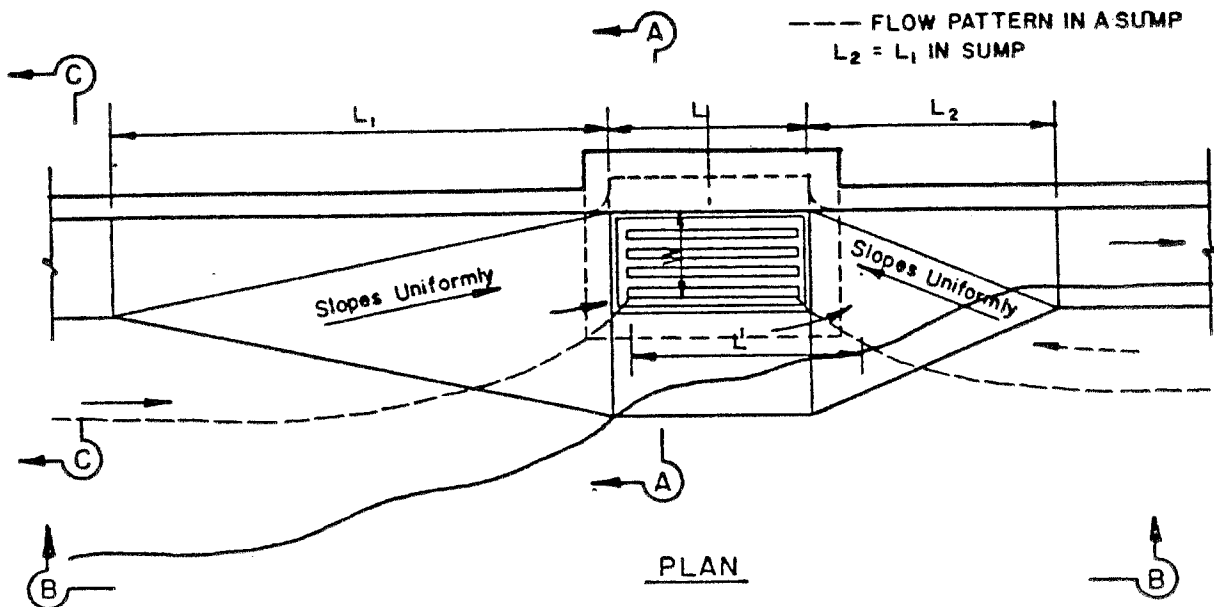

$$E = y + \frac{v_0^2}{2g} + a$$

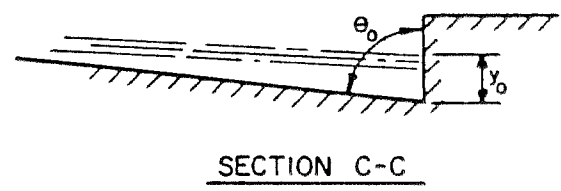
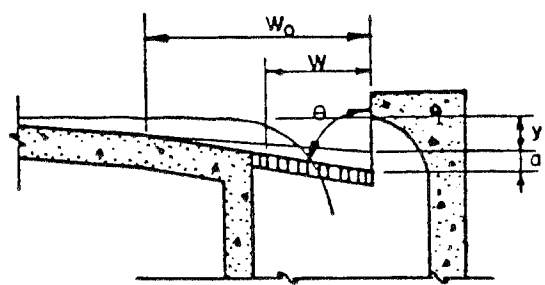

DEPRESSED COMBINATION INLET
 TYPE A-3 & C-3

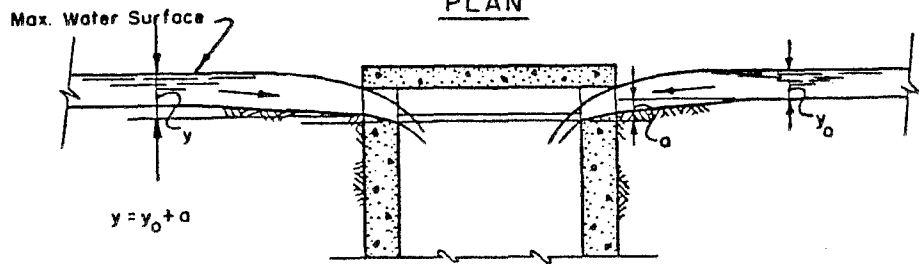
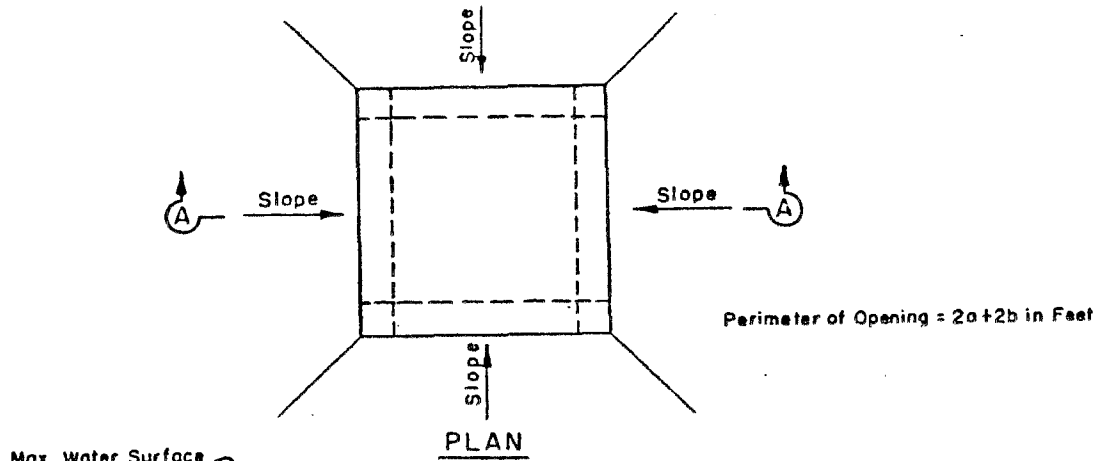

SECTION A-A
 DROP INLET
 TYPE A-4

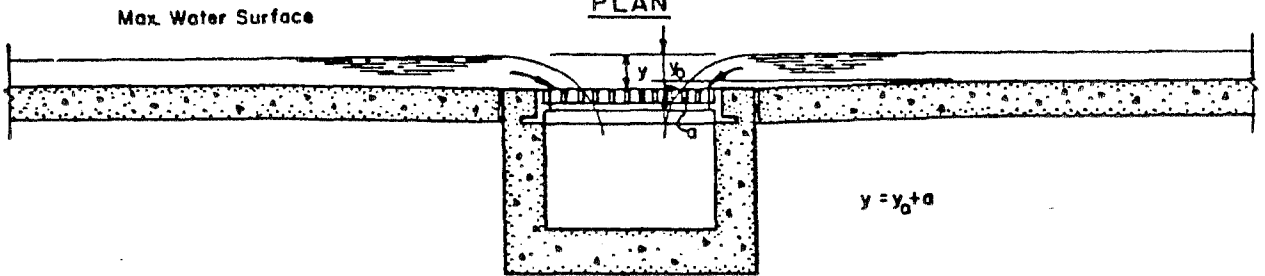
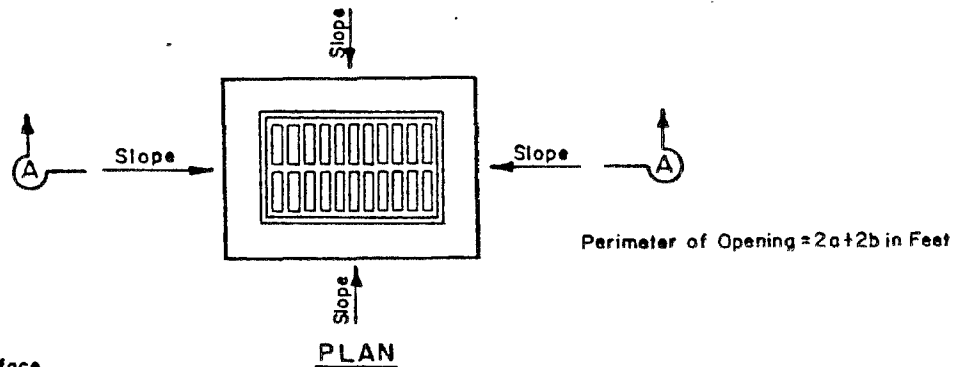

SECTION A-A
 DROP INLET
 (Grate covering)
 TYPE A-5

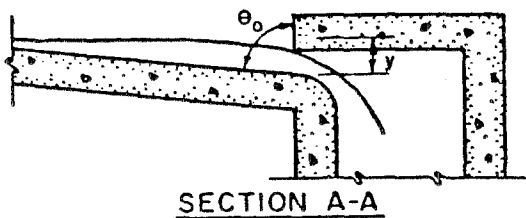
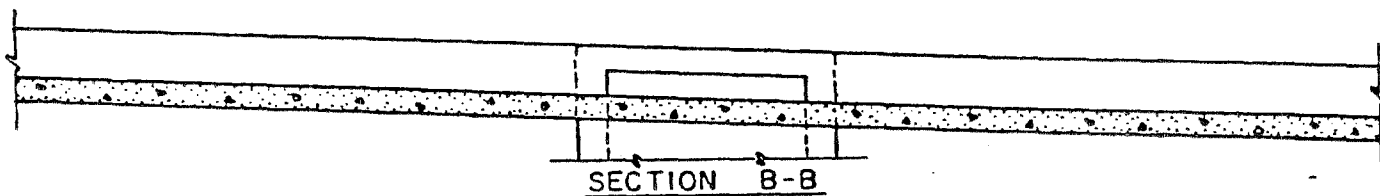
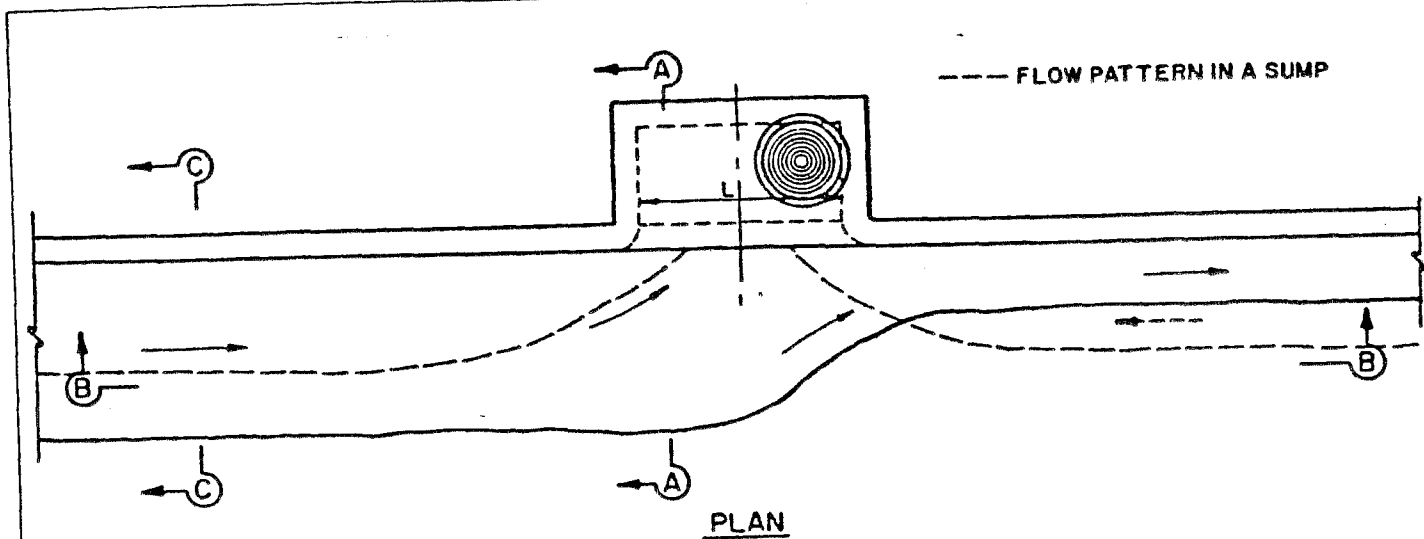

$y = y_0$

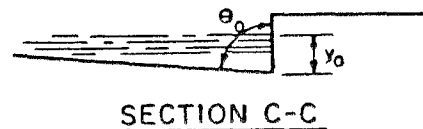

UNDEPRESSED CURB-OPENING
INLET TYPE A-1 & B-1 (RECESSED)

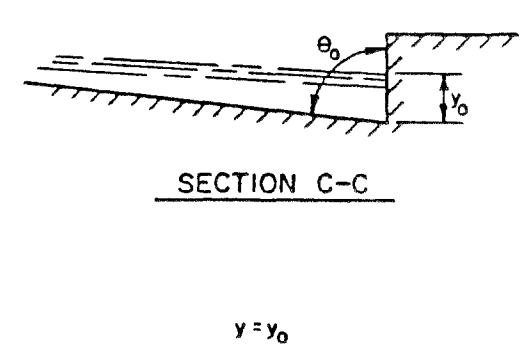
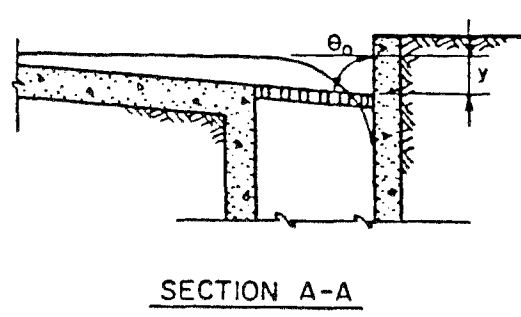
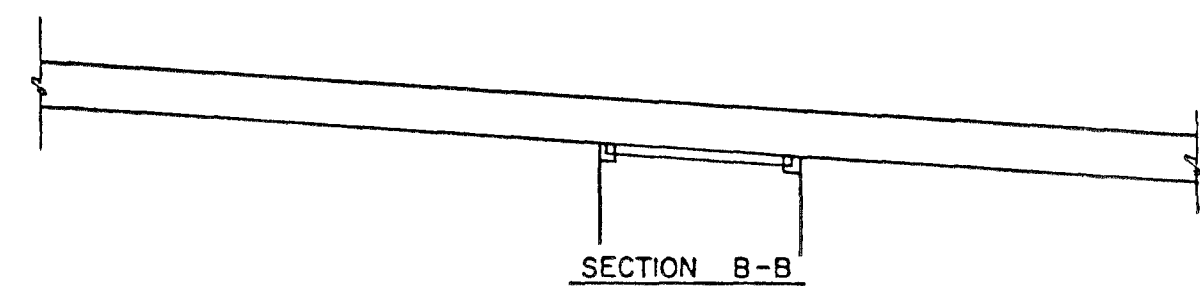
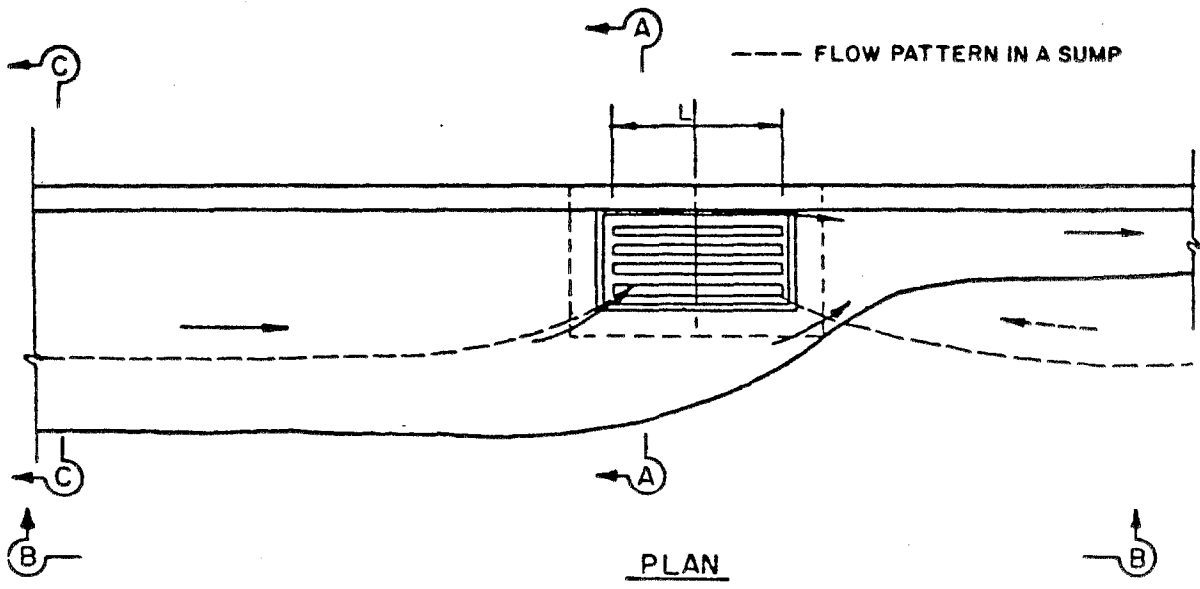

UNDEPRESSED GRATE INLET
TYPE A-2 & B-2

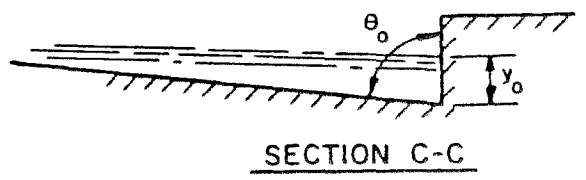
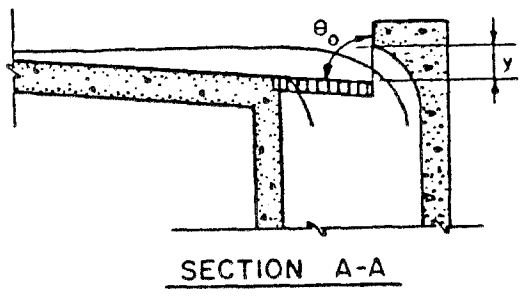
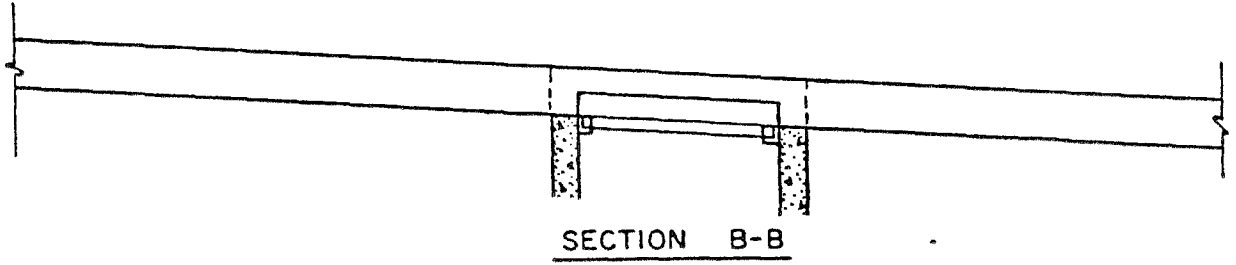
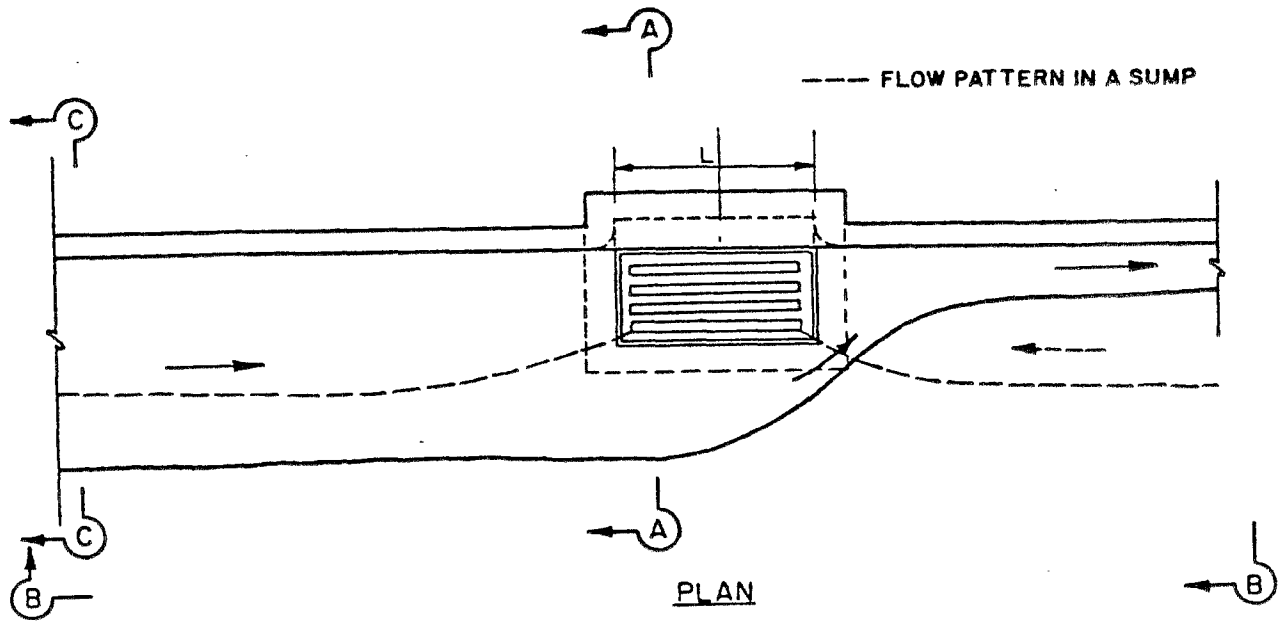

$y = y_0$

UNDEPRESSED COMBINATION
INLET TYPE A-3 & B-3 (RECESSED)

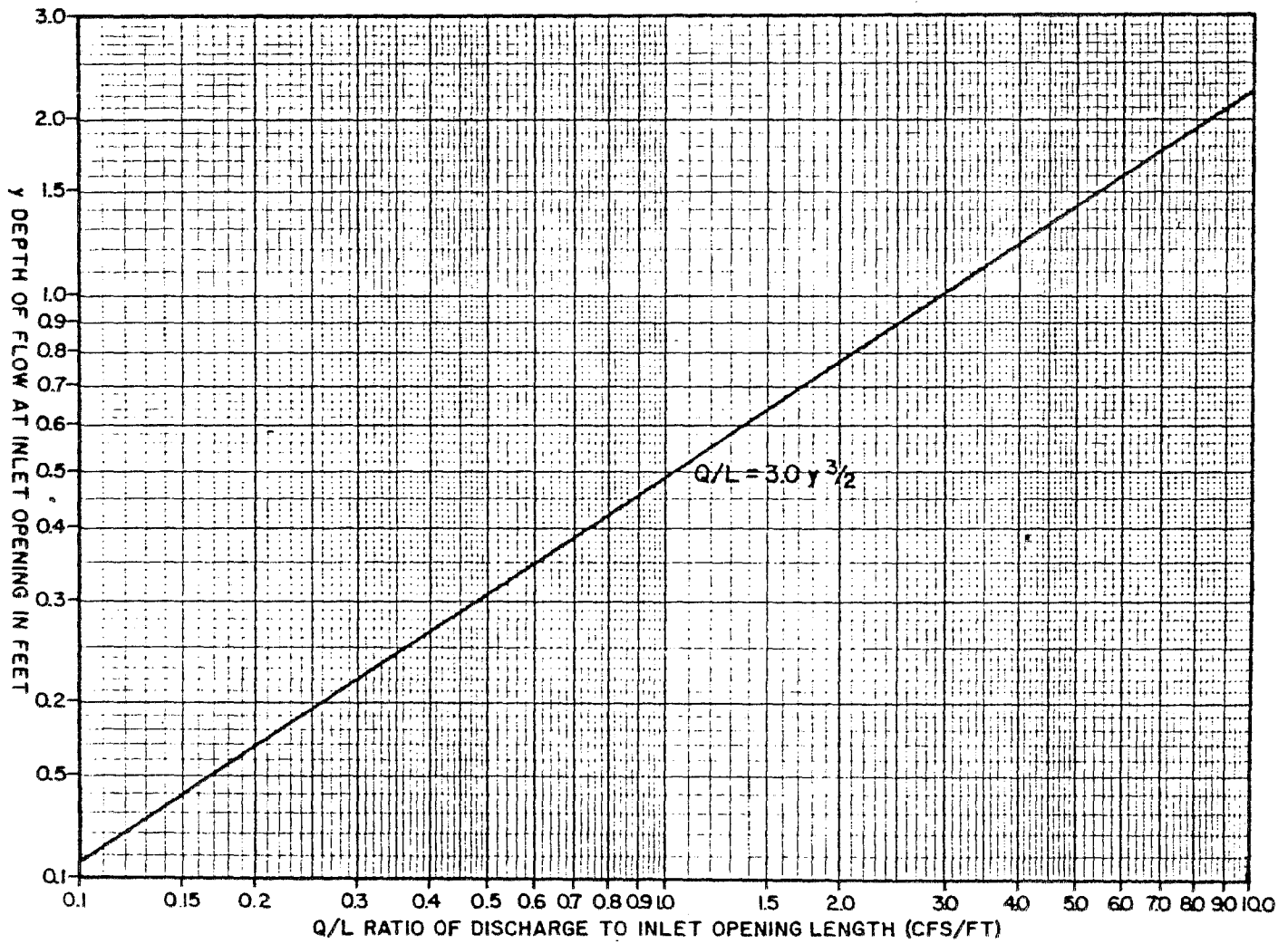

INLET CAPACITY TYPE A-1 & A-4

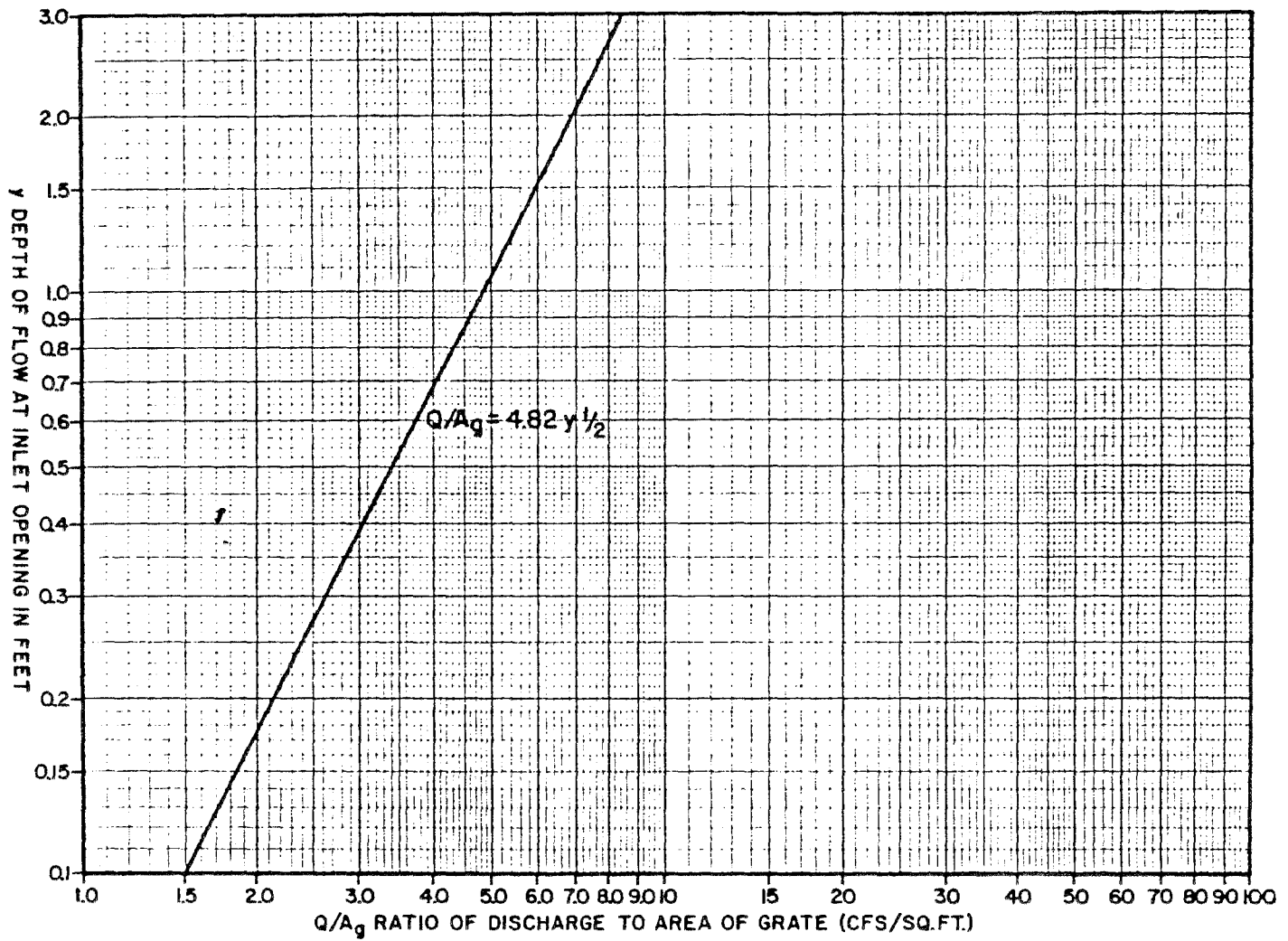

INLET CAPACITY TYPE A-2 & A-5

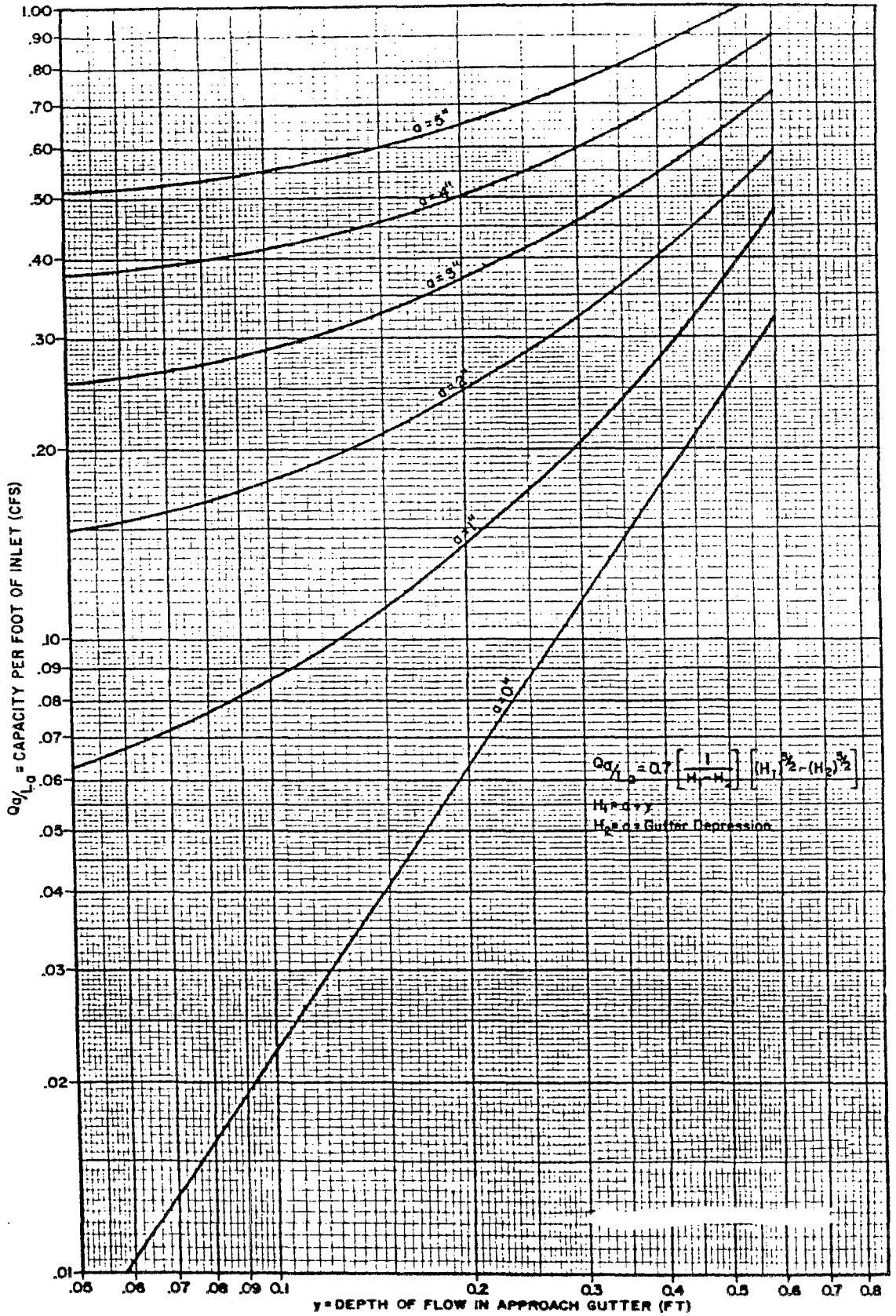

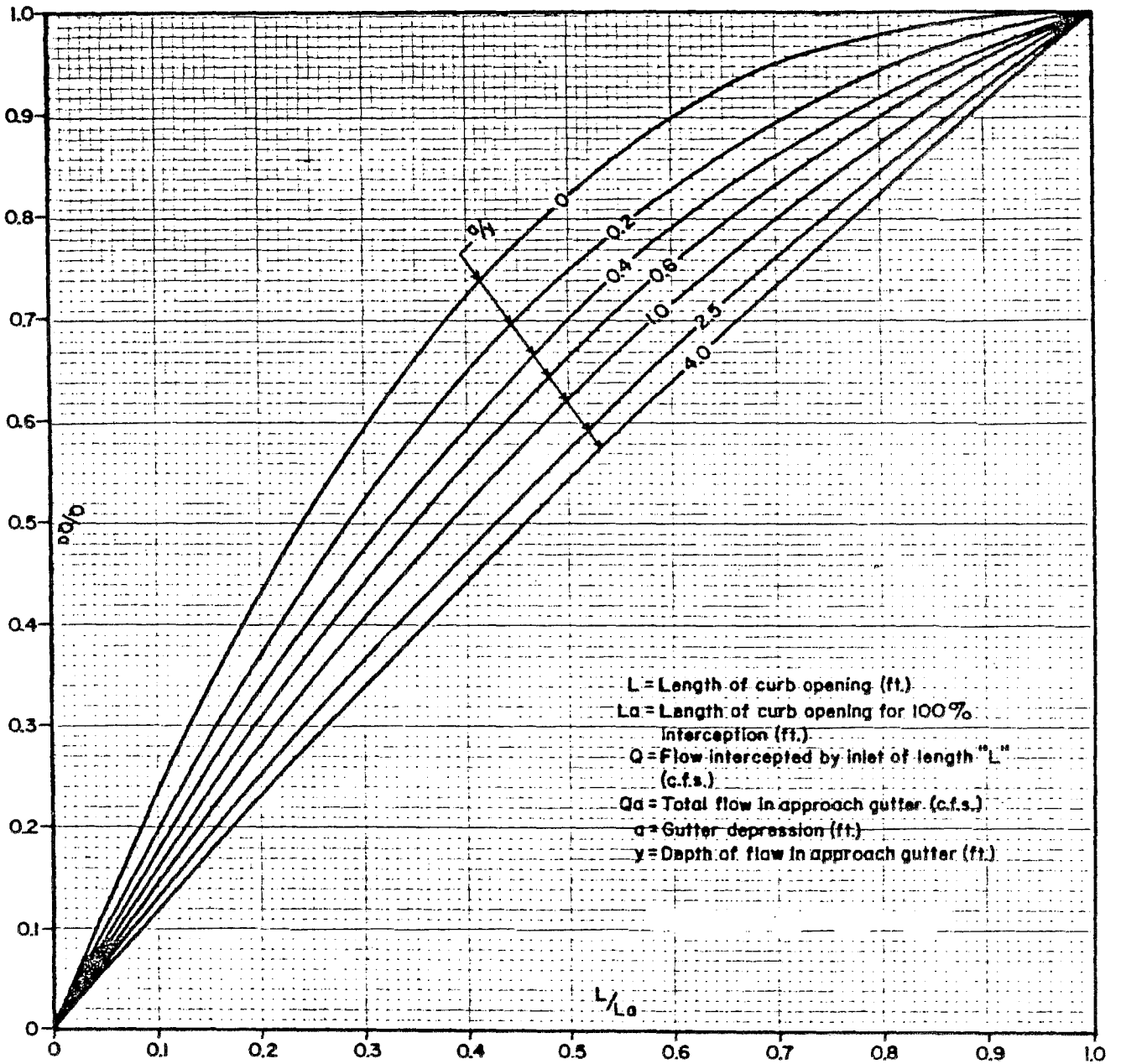

RATIO OF INTERCEPTED TO TOTAL FLOW FOR INLETS ON GRADE

7-7. STANDARD CURB-OPENING INLET CHART

EXAMPLE

W = 2 ft.
 a = 2 in.
 h = 6 in.

One inch is 25.4mm
 One foot is 0.3048m

Given — $S_x = 0.02$ ft./ft.
 $T = 10$ ft.
 $S_o = 0.03$ ft./ft.

Find — $L_i = 11.8$ ft. $L_j = 34$ ft.
 $Q_i/Q = 0.65$ $Q_j/Q = 1.0$

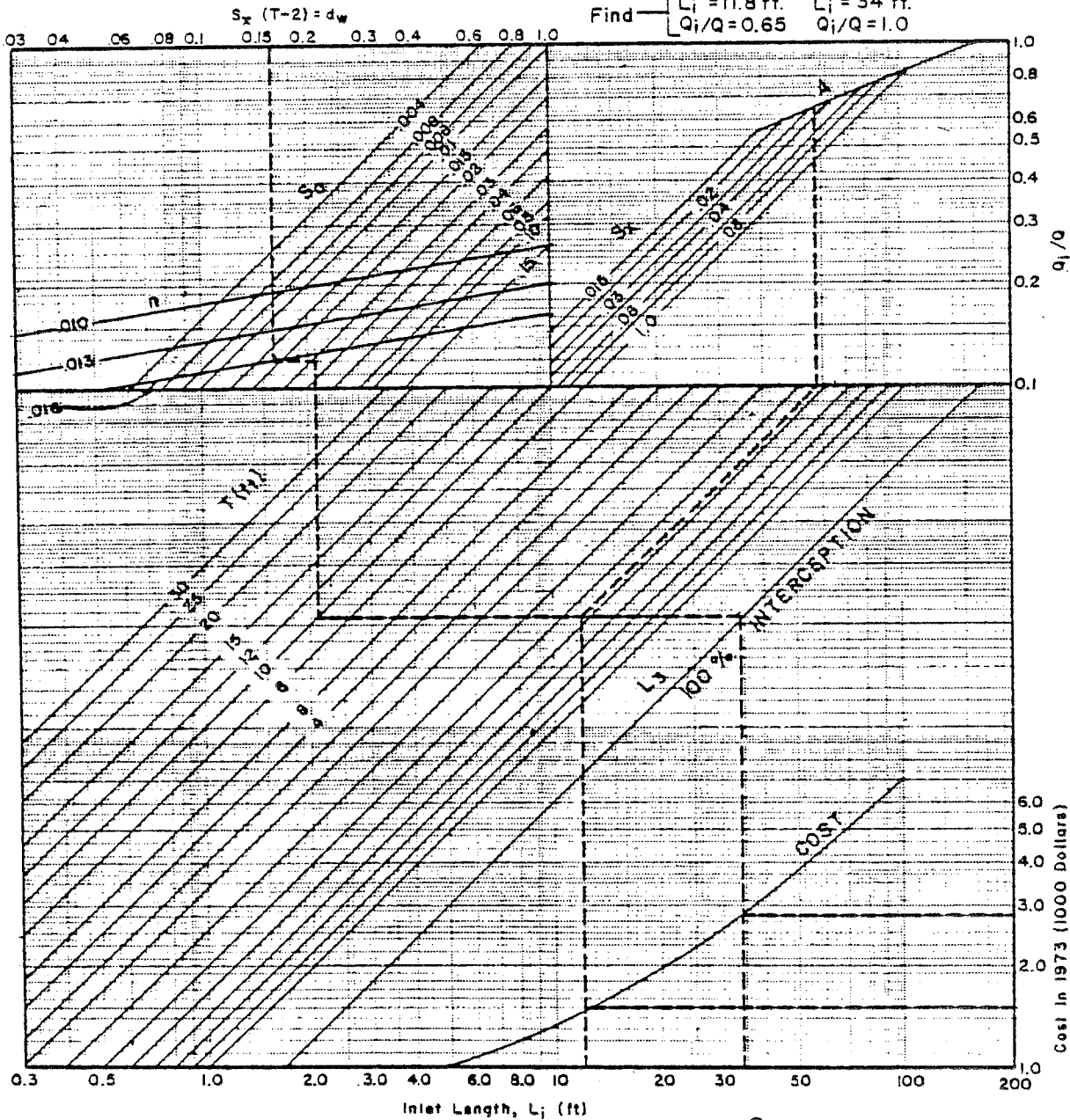

After Izzard (Ref. 5-5)

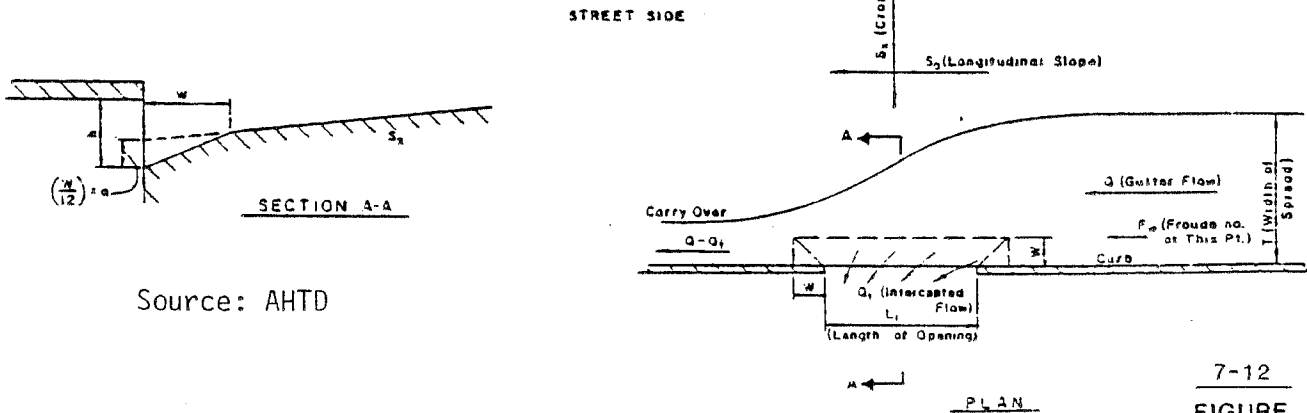

Source: AHTD

Curb Opening Inlet Design Chart

Izzard (Ref. 5-8), from whom is taken this discussion of the hydraulics of curb opening inlets, has developed Fig. 5-6 as a graphical solution for standard curb opening inlet design. His work is based upon original experimental data for full-scale inlets reported in 1961 by Karaki and Haynie (Ref. 5-4) which was analyzed by Bauer and Woo (Ref. 5-9). The graphical solution presented here has the advantage of being applicable to any grade (S_o), cross slope (S_x), roughness coefficient (n), and flow spread (T), while giving a direct reading from a single chart. Fig. 5-6 is based upon $w = 2$ feet (0.610m); $a = 2$ inches (50.8mm) and $h = 6$ inches (152.4mm). The achievement of an h substantially equal to 6 inches (152.4mm) with a depression of 2 inches (50.8mm) and a 6-inch (152.4mm) curb height can be accomplished as illustrated by a standard curb inlet of the Virginia Department of Highways and Transportation, (Fig. 5-7).

The use of the chart (Fig. 5-6) is illustrated by an example in dotted lines and described as follows:

1. The starting point is in the street section at a point w (2 feet (0.610m) from the curb face), where the depth of flow is d_w .
2. The example assumes $S_x = 0.02$ feet per foot (0.02mm per m); $T = 10$ feet (3.048m); $S_o = 0.03$ feet per foot (0.03mm per m) and $n = .016$. It requires the determination of inlet lengths to accept Q_i/Q ratios of 0.65 and 1.0.
3. Enter at top left-hand edge of chart the value of $S_x(T-2)$ which for the example is .02 (10-2) or 0.16.
4. Follow vertically down to the line representing Manning's n of 0.016.
5. Move horizontally across to longitudinal slope S_o of 0.03.
6. Follow vertically down to flow spread T of 10 feet (3.048m). This establishes a horizontal line for the example.
7. With the given Q_i/Q of 0.65, enter the upper right of the chart, follow horizontally across to line A or line for ~~assumed~~ S_x whichever is intersected first.
8. Move vertically down to the lower margin of the upper right quadrant where Q_i/Q is 0.1 and then, diagonally to intersection with the horizontal line in step 6.
9. Follow vertically down to find the required inlet length L_i ; for the example, 11.8 feet (3.597m).
10. The horizontal line in step 6 can be continued to the right until it intersects the sloping line L_3 , to find the needed curb opening to achieve 100% interception. From intersection with line L_3 move vertically down to the 100% inlet length. For the example, this is 34 feet (10.363m).
11. If the length of inlet is given, enter with that length, move up to the horizontal line established in step 6, diagonally to $Q_i/Q = 0.1$, then vertically to S_x (or line A) and across to Q_i/Q .

The cost curve in the lower right corner of Fig. 5-6 shows how inlet costs may be estimated. It is based upon 1973 contract prices for Virginia State Highway Department curb opening inlets. It can be useful in consideration of alternate criteria for T and S_x .

The maximum interception per foot (metre) of inlet occurs in the straight portion of the function in Fig. 5-5. Since cost is related to length, the least cost per cfs (m^3/s) intercepted, occurs in this range.

As illustrated in the example, the length of inlet decreases markedly when Q_i/Q is assumed as less than 1.0. If a slight increase in spread T is tolerable for successive inlets, the carry-over flow added to the runoff from the intervening watershed increases the interception ratio. Consequently, by the third inlet, all the intervening flow is intercepted. Cost savings can be substantial even when the last inlet is sized to pick up the total flow.

SECTION VIII - STORM SEWER DESIGN

8.1 General

8.2 Preliminary Design Considerations

8.3 Inlet System

8.4 Storm Sewer System

8.4.1 Storm Sewer Pipe

8.4.2 Junctions, Inlets and Manholes

SECTION VIII - STORM SEWER DESIGN

8.1 GENERAL

All storm drains shall be designed by the application of the Manning equation either directly or through appropriate charts or nomographs. In the preparation of hydraulic designs, a thorough investigation shall be made of all existing structures and their performance of the waterways in question.

The design of the storm drainage system should be governed by the following six conditions:

1. The system must accommodate all surface runoff resulting from selected design storm without serious damage to physical facilities or substantial interruptions of normal traffic.
2. Runoff resulting from storms exceeding the design storm must be anticipated and disposed of with minimum damage to physical facilities and minimum interruption of normal traffic.
3. The storm drainage system must have a maximum reliability of operation.
4. The construction cost of the system must be reasonable with relationship to the importance of the facilities it protects.
5. The storm drainage system must require minimum maintenance and must be accessible for maintenance operations.
6. The storm drainage system must be adaptable to future expansion with minimal additional costs.

An example of the design of the storm drainage system is outlined in Paragraphs 8.3 and 8.4. The design theory has been presented in the preceding sections with corresponding tables and graphs of information.

8.2 PRELIMINARY DESIGN CONSIDERATIONS

- A. Prepare a drainage map of the entire area to be drained by proposed improvements. Contour maps serve as excellent area drainage maps when supplemented by field reconnaissance.
- B. Make a tentative layout of the proposed storm system, locating all inlets, manholes, mains, laterals, ditches, culverts, etc.

- C. Outline the drainage area for each inlet in accordance with present and future street development.
- D. Indicate on each drainage area the size of the area, the direction of surface runoff by small arrows and coefficient of runoff for the area.
- E. Show all existing underground utilities.
- F. Establish design rainfall frequency.
- G. Establish minimum inlet time of concentration.
- H. Establish the typical cross section on each street.
- I. Establish permissible spread of water on all streets within the drainage area.
- J. Include A. through I. with plans submitted to the Engineering Department for review. The drainage map submitted shall be suitable for permanent filing in the Engineering Department and shall be a good quality reproducible.

8.3 INLET SYSTEM

Determining the size and location of inlets is largely a trial and error procedure. Using criteria outlined in earlier sections of this manual, the following steps will serve as a guide to the procedure to be used.

- A. Beginning at the upstream end of the project drainage basin, outline a trial subarea and calculate the runoff from it.
- B. Compare the calculated runoff to allowable street capacity. If the calculated runoff is greater than the allowable street capacity, reduce the size of the trial subarea. If the calculated runoff is less than street capacity, increase the size of the trial subarea. Repeat this procedure until the calculated runoff equals the allowable street capacity. This is the first point at which a portion of the flow must be removed from the street. The percentage of flow to be removed will depend on street capacities versus runoff entering the street downstream.
- C. Record the drainage area, time of concentration, runoff coefficient, and calculated runoff for the subarea. This information shall be recorded on the plans or in tabular form convenient for review.
- D. If an inlet is to be used to remove water from the street, size of the inlet(s) and record the inlet

size, amount of intercepted flow, and amount of flow carried over (bypassing the inlet).

- E. Continue the above procedure for other subareas until a complete system of inlets has been established. Remember to account for carry-over from one inlet to the next.
- F. After a complete system of inlets has been established, modification should be made to accommodate special situations such as point sources of large quantities of runoff, and variation of street alignments and grades.
- G. Record information as in C. and D. for all inlets.
- H. After the inlets have been located and sized, the inlet pipes can be designed.
- I. Inlets pipes are sized to carry the volume of water intersected by the inlet. Inlet pipe capacities may be controlled by the gradient available, or by entry condition into the pipe at the inlet. Inlet pipe sizes should be determined for both conditions in the larger size thus determined used.

8.4 STORM SEWER SYSTEM

After the computation of the quantity of runoff entering each inlet, the storm sewer system required to carry off the runoff is designed. It should be borne in mind that the quantity of flow to be carried by any particular section of the storm sewer system is not the sum of the inlet design quantities of all inlets above that section of the system, but is less than the straight total. This situation is due to the fact that as the time of concentration increases the rainfall intensity decreases.

8.4.1 STORM SEWER PIPE

The ground line profile is now used in conjunction with the previous runoff calculations. The elevation of the hydraulic gradient is arbitrarily established approximately 2 feet below the ground surface. When this tentative gradient is set and the design discharge is determined, a Manning flow chart may be used to determine the pipe and velocity.

It is probable that the tentative gradient will have to be adjusted at this point since the intersection of the discharge in the slope on the chart will likely occur between standard pipe sizes. The smaller pipe should be used if the design discharge and corresponding slope does not result in an encroachment on the 2-foot criteria below the ground surface. If there is an encroachment, use the

larger pipe which will establish a capacity somewhat in excess of the design discharge. Velocities can be read directly from a Manning flow chart based on a given discharge, pipe size, and gradient slope.

8.4.2 JUNCTIONS, INLETS, AND MANHOLES

- A. Determine the hydraulic gradient elevation at the upstream end and downstream end of the pipe section in question. The elevation of the hydraulic gradient of the upstream end of the pipe is equal to the elevation of the downstream (hydraulic gradient) plus the product of the length of the pipe and the pipe gradient.
- B. Determine the velocity of flow for incoming pipe (main line) at junction, inlet or manhole at design point.
- C. Determine the velocity of flow for outgoing pipe (main line) at junction, inlet or manhole at design point.
- D. Compute velocity head for outgoing velocity (main line) at junction, inlet, or manhole at design point.
- E. Compute velocity head for incoming velocity (main line) at junction, inlet or manhole at design point.
- F. Determine head loss coefficient "K" at junction, inlet, or manhole at design point from Tables 3-4, 3-5, 3-6, or Figures 3-10, 3-11.
- G. Compute head loss at junction, inlet, or manhole.

$$h_j = K_j (v_2^2 - v_1^2)/2g$$
- H. Compute hydraulic gradient at upstream end of junction as if junction were not there.
- I. Add head loss to hydraulic gradient elevation determined to obtain hydraulic gradient elevation at upstream end of junction.

All information shall be recorded on the plans or in tabular form convenient for review.

SECTION IX - OPEN CHANNEL FLOW

- 9.1 General
- 9.2 Design Criteria
 - 9.2.1 Design Storms
 - 9.2.2 Manning's Equation
 - 9.2.3 Channel Cross Sections
- 9.3 Channel Drop
- 9.4 Baffle Chutes
- 9.5 Structural Aesthetics
- 9.6 Computation Format
- 9.7 Channel Lining Design
 - 9.7.1 Unlined Channels
 - 9.7.2 Temporary Linings
 - 9.7.3 Grass Linings
 - 9.7.4 Rock Riprap
- 9.8 Design of Granular Filter Blanket
- 9.9 Concrete

SECTION IX - OPEN CHANNEL FLOW

9.1 GENERAL

Open channels for use in the major drainage system have significant advantage in regard to cost, capacity, multiple use for recreational and aesthetic purposes, and potential for detention storage. Disadvantages include right-of-way needs and maintenance costs. Careful planning and design are needed to minimize the disadvantages, and to increase the benefits.

Open channels may be used in lieu of storm sewers to convey storm runoff where:

- (1) Sufficient right-of-way is available;
- (2) Sufficient cover for storm sewers is not available;
- (3) To maintain compatibility with existing or proposed developments; and
- (4) Where economy of construction can be shown without long-term public maintenance expenditures.

Intermittent alternating reaches of opened and closed systems should be avoided. Closed systems are preferred due to the inherent hazard of open channels and urban areas and the tendency for trash to collect in open channels.

The ideal channel is a natural one carved by nature of a long period of time. The benefits of such a channel are that:

- (1) Velocities are usually low, resulting in longer concentration times and lower downstream peak flows.
- (2) Channel storage tends to decrease peak flows.
- (3) Maintenance needs are usually low because the channel is somewhat stabilized.
- (4) The channel provides a desirable green belt and recreational area adding significant social benefits.

Generally speaking, the natural channel or the man-made channel which most nearly conforms to the character of the natural channel is the most efficient and the most desirable.

The City has adopted an ongoing ditch maintenance program that is based upon comprehensive field inventories and analysis, and a system of establishing priorities based upon flooding potentials.

In many areas facing urbanization, the runoff has been so minimal that natural channels do not exist. However, a small trickle path nearly always exists which provides an excellent basis for location and construction of channels. Good land planning should reflect even these minimal trickle channels to reduce development cost and minimize drainage problems. In most cases, the prudent utilization of natural water routes in the development of major drainage system will reduce the requirements for an underground storm sewer system.

Channel stability is a well recognized problem in urban hydrology because of the significant increases in low flows and peak storm runoff flows. A natural channel must be studied to determine the measures needed to avoid future bottom scour and bank cutting. Erosion control measures can be taken at a reasonable cost which will preserve the natural appearance without sacrificing hydrologic efficiency. This also helps reduce public cost and maintaining the channel in the future.

For safety purposes, open channels should be fenced or graded to reduce potential injury to the public. Sufficient right-of-way or permanent easements should be provided adjacent to open channels to allow entry of City maintenance vehicles.

9.2 DESIGN CRITERIA

Open channels shall be designed to the following criteria:

9.2.1 DESIGN STORM

- (1) Minor design storm - 10-year
- (2) Central Business District - 50-year
- (3) Major Storm - 100-year

9.2.2 CHANNEL DISCHARGE - MANNING'S EQUATION

Careful attention must be given to the design of drainage channels to assure adequate capacity and minimum maintenance to overcome the results of vegetative growth, erosion, and silting. The hydrologic characteristics of channels shall be determined by Manning's equation.

$$Q = \frac{1.49}{n} A R^{2/3} S^{1/2}$$

Q = Total discharge and CFS

n = Coefficient of roughness

A = Cross-sectional area of channel (square feet)

R = Hydrologic radius of channel (feet)

S = Slope of the frictional gradient (feet per foot)

For a given channel condition of roughness, discharge and slope, there is only one possible depth for maintaining a uniform flow. This depth is the normal depth. When roughness, depth, and slope are known at a channel section, there can only be one discharge for maintaining a uniform flow through the section. This discharge is the normal discharge.

If the channel is uniform and resistance and gravity forces are in exact balance, the water surface will be parallel to the bottom of the channel. This is the condition of uniform flow.

Uniform flow is more often a theoretical abstraction than an actuality. True uniform flow is difficult to find in the field or to obtain in the laboratory. Channels are sometimes designed on this assumption that they will carry uniform flow at the normal depths, but because of conditions difficult if not impossible to evaluate and hence not taken into account, the flow will actually have depths considerably different from uniform depth. The engineer must be aware of the fact that uniform flow computation provides only an approximation of what will occur; however, such computations are useful and necessary for planning.

The normal depth is computed so frequently that it is convenient to use nomographs for such types of cross sections to eliminate the need for trial and error solutions, which are time-consuming. A nomograph for uniform flow is given in Figure 9-1.

Open channel flow in urban drainage systems is usually nonuniform because of bridge openings, curbs, and structures. This necessitates the use of backwater computations for all final channel design work.

A water surface profile must be computed for all channels and shown on all final drawings. Computation of the water surface profile should utilize standard backwater methods or acceptable computer routines, taking into consideration all losses due to the changes in velocity, drops, bridge openings, and other obstructions.

Channels should have trapezoidal sections of adequate cross-sectional areas to take care of uncertainties and runoff estimates, changes in channel coefficients, channel obstructions, and silt accumulations.

EXAMPLE

GIVEN	FIND	SOLUTION
S = 0.003	d	$d/W = 0.086$
Q = 1,000		$d = 40 \times 0.086$
n = 0.029		$= 3.44'$
W = 40		
SS = 4:1		

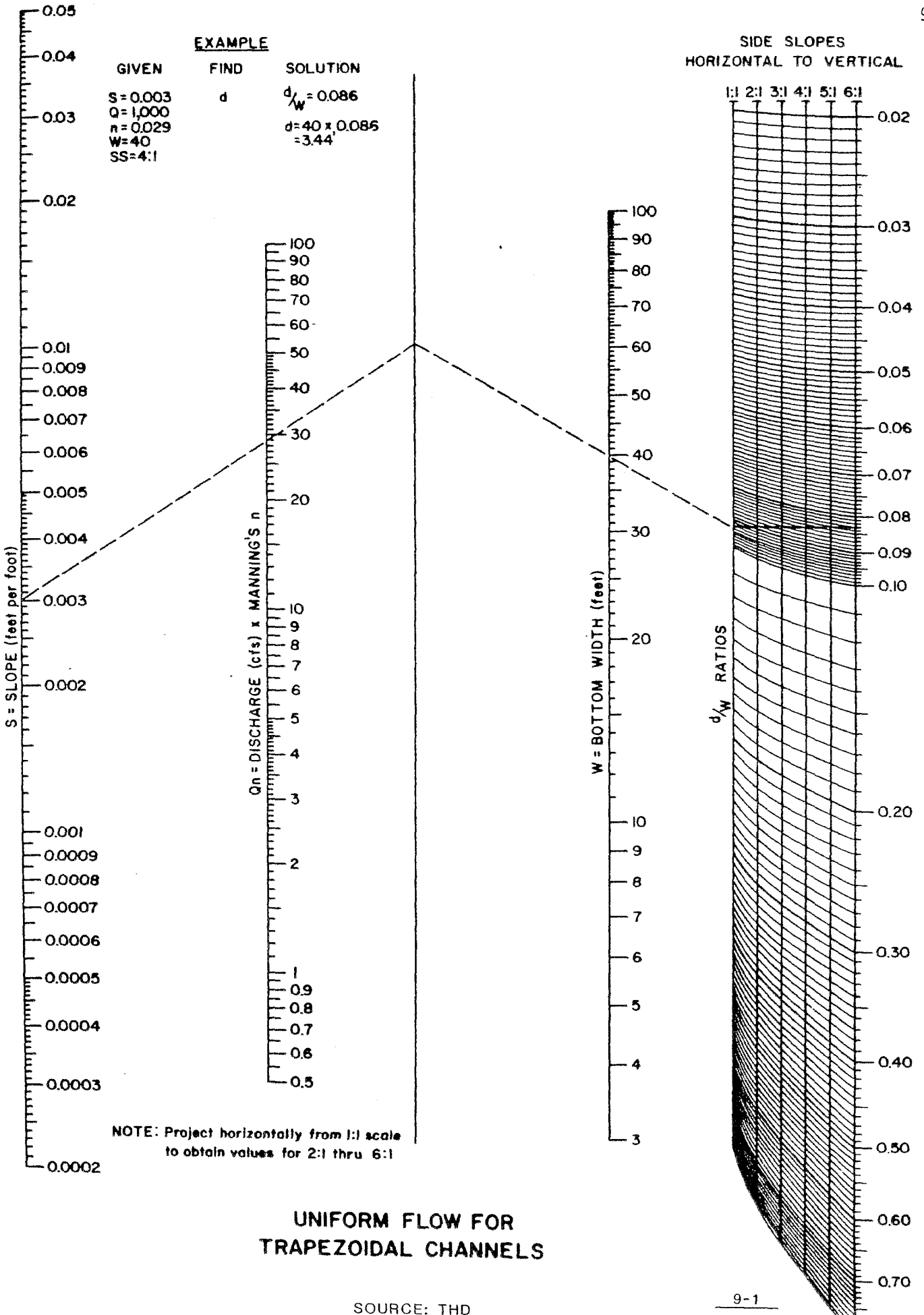

NOTE: Project horizontally from 1:1 scale to obtain values for 2:1 thru 6:1

UNIFORM FLOW FOR TRAPEZOIDAL CHANNELS

Accurate determinations of the "n" value is critical in the analysis of the hydraulic characteristics of a channel. The "n" value of each channel reach should be based on experience and judgment with regard to the individual channel characteristics. Table 9-1 gives a method of determining the composite roughness coefficient based on actual channel conditions.

Where practicable, unlined channels should have sufficient gradient, depending upon the type of soil, to provide velocities that will be self-cleaning but will not be so great as to create erosion. Lined channels, drop structures, check dams, or concrete spillways may be required to control erosion that results from the high velocities of large volumes of water. Unless approved otherwise by the Director of Engineering, channel velocities and man-made channels shall not exceed 6 feet per second. Where velocities in excess of 6 feet per second are encountered, riprap, pavement, or other approved protective measures shall be required. As minimum protection to reduce erosion all open channels slopes shall be seeded or sodded as soon after grading as possible.

9.2.3 CHANNEL CROSS SECTIONS

The channel shape may be almost any type suitable to the location and to the environmental conditions. Often the shape can be chosen to suit open space and recreational needs to create additional benefits.

(1) Side Slope

Except in horizontal curves, the flatter the side slope, the better. Normally, slopes shall be no steeper than 3:1, which is also the practical limit for mowing equipment. Rock or concrete lined channels or those that for other reasons do not require slope maintenance may have slopes as steep as 1 1/2:1, or designed rectangular if walls are structurally designed.

(2) Depth

Deep channels are difficult to maintain and can be hazardous. Constructed channels should, therefore, be as shallow as practical.

(3) Bottom Width

Channels with narrow bottoms are difficult to maintain and are conducive to high velocities during high flows. It is desirable to design open channels such that the bottom width is at least twice the depth.

Table 9-1
Computation of Composite Roughness Coefficient
For Excavated and Natural Channels

$$n = (n_0 + n_1 + n_2 + n_3 + n_4) m$$

	Channel Conditions	Value
Material Involved n_0	Earth	0.020
	Rockcut	0.025
	Fine Gravel	0.024
	Coarse Gravel	0.028
Degree of Irregularity n_1	Smooth	0.000
	Minor	0.005
	Moderate	0.010
	Severe	0.020
Variation of Channel Cross Section n_2	Gradual	0.000
	Alternating Occasionally	0.005
	Alternating Frequently	0.010-0.015
Relative Effect Of Obstructions n_3	Negligible	0.000
	Minor	0.010-0.015
	Appreciable	0.020-0.030
	Severe	0.040-0.060
Vegetation n_4	Low	0.005-0.010
	Medium	0.010-0.025
	High	0.025-0.050
	Very High	0.050-0.100
Degree of Meandering m	Minor	1.000-1.200
	Appreciable	1.200-1.500
	Severe	1.500

Roughness Coefficient For Lined Channels

Concrete Lined - $n = 0.017$
 Rubble RipRap - $n = 0.022$

Open Channel Hydraulics
 Ven Te Chow, Ph.D.

(4) Bend Radius

Twenty-five (25) feet or ten (10) times the bottom width, whichever is larger, is the minimum bend radius required for open channels.

(5) Trickle Channels

The low flows, and sometimes base flows, from urban areas must be given specific attention. If erosion of the bottom of the channel appears to be a problem, low flows shall be carried in a paved trickle channel which has a capacity of 5.0 percent of the design peak flow. Care must be taken to ensure that low flows enter the trickle channel without the attendant problem of the flow paralleling the trickle channel.

(6) Freeboard

For channels with flow at high velocities, surface roughness, wave action, air bulking, and splash and spray are quite erosive along the top of the flow. Freeboard height should be chosen to provide a suitable safety margin. The height of freeboard should be a minimum of 1-foot, or provide an additional capacity of approximately one-third of the design flow. For deep flows with high velocities, one may use the formula:

Freeboard (in feet) = $1.0 + 0.025 V D^{1/3}$, where

V = Velocity of flow

D = Depth of flow

For the freeboard of a channel on a sharp curve, extra height must be added to the outside bank or wall in the amount:

$$H = \frac{V^2 (T+B)}{2gR}$$

H = Additional height on outside edge of channel (feet)

V = Velocity of flow in channel (feet per sec.)

T = Width of flow at water surface (feet)

B = Bottom width of channel (feet)

R = Centerline radius of turn (feet)

g = Acceleration of gravity (32.2 feet per sec.²)

If R is equal or greater than $3 \times B$, additional freeboard is not required.

(7) Connections

Connections at the junction of two or more open channels shall be smooth. Pipe and box culvert or sewers entering an open channel will not be permitted to project into the normal channel section. Nor will they be permitted to enter an open channel at an angle which would direct flow from the culvert or sewer upstream in the channel.

9.3 CHANNEL DROP

The use of channel drops permits adjustment of channel gradients which are too steep for the design conditions. In urban drainage work, it is often desirable to use several low head drops in lieu of a few higher drops.

The use of sloped drops will generally result in lower cost installation. Sloped drops can easily be designed to fit the channel topography.

Sloped drops shall have roughened faces and shall be no steeper than 2:1. They shall be adequately protected from scour, and shall not cause an upstream water surface drop which will result in high velocities upstream. Side cutting just downstream from the drop is a common problem which must be protected against.

The length L will depend upon the hydraulic characteristics of the channel and drop. For a Q of 30 cubic feet per second/feet, L would be about 15 feet, that is, about 1/2 of the Q value. The L should not be less 10 feet, even for low Q values. In addition, follow-up riprapping will often be necessary at most drops to more fully protect the banks and channel bottom. The criteria given is minimal, based on the philosophy that it's less costly to initially under protect with riprap, than to place additional protection after erosional tendencies are determined in the field. Project approvals are to be based on provisions for such follow-up construction.

9.4 BAFFLE CHUTES

Baffle chutes are used to dissipate the energy in the flow at a larger drop. They require no tailwater to be effective, they are partially useful where the water surface upstream is held at a higher elevation to provide head for filling a side storage pond during peak flows.

Baffle chutes are used in channels where water is to be lowered from level to another. The baffle piers prevent undue acceleration of the flow as it passes down the chute. Since the flow velocities entering the downstream channel are low, no stilling basin is needed. The chute, on a 2:1 slope or flatter, may be designed to discharge to 60 CFS per foot per foot of width, and the drop may be as high as structurally feasible. The lower end of the chute is constructed to below stream bed level and backfilled as necessary. Degradation of the streambed does not, therefore, adversely effect the performance of the structure. In urban drainage design, the lower end should be protected from the scouring action.

The baffled apron shall be designed for the full discharge design flow. Baffle chutes shall be designed using acceptable methods such as those presented by A.S. Peterka of the United States Bureau of Reclamation and Engineering Nomograph No. 25.

9.5 STRUCTURAL AESTHETICS

The use of hydrologic structures in the urban environment requires an approach not encountered elsewhere in the design of such structures. The appearance of these structures is very important. The treatment of the exterior should not be considered of minor importance. Appearance must be an integral part of the design.

Parks. It must be remembered that structures are often the only above-ground indication of the underground works involved in an expensive project. Furthermore, parks and green belts may later be developed in the area in which the structure will play a dominant environmental role.

Play areas. An additional consideration is that the drainage structures offer excellent opportunities for neighborhood children to play. It is almost impossible to make drainage works inaccessible to children, and therefore, what is constructed should be made as safe as is reasonably possible. Safety hazards should be minimized and vertical drops protected with decorative fencing or rails.

Concrete service treatment. The use of textured concrete presents a pleasing appearance and removes form marks. Exposed aggregate concrete is also attractive but may require special control of aggregate used in the concrete.

Rails and fences. The use of rails and fences along concrete walls provides a pleasing topping to an otherwise stark wall, and yet gives a degree of protection against someone inadvertently falling over the wall.

9.6 COMPUTATION FORMAT

Figure 9-2 is to be used for open channel design. The steps to follow an open channel design are:

1. List all the design data (i.e., location, area, runoff coefficients, typical section, slope, etc.).
2. Determine the initial time of concentration (T_0).
3. Estimate travel time (T_d) through study reach and add to initial time of concentration to obtain time concentration (T_c) at lower end of study reach.
4. Determine the discharge for the design storm using T_c .
5. Enter the appropriate channel design chart with the discharge in the slope to find the velocity and depth of flow.
6. Check the estimated travel time against the calculated velocity.
 - A. If the estimated travel time is comparable to the calculated travel time (± 1.0 min.) proceed to Step 7.
 - B. If the estimated travel time does not check with the calculator travel time, repeat Steps 3-6 until an agreement is reached.
7. If excessive velocities or water depths are determined, select another typical section, revise channel grade, or revise lining and repeat Steps 3-7.
8. Similar calculations are to be made to determine operational characteristics - freeboard, velocity, etc.

9.7 CHANNEL LINING DESIGN

9.7.1 UNLINED CHANNELS

The design charts for unlined channels (bare soils) are based on tests on 10 different classes of soils, ranging from cohesive clays to noncohesive sands and gravels. These are Figures 9-3 and 9-4. Generally, sandy, noncohesive soils tend to be very erodible, the large grained gravel clay-silt mixtures are erosion resistant, and the mixtures of sand, clay, and colloids are moderately erodible.

9.7.2 TEMPORARY LININGS

Temporary linings are flexible coverings used to protect a channel until permanent vegetation can be established using

DITCH DESIGN FORM

LOCATION	AREA ACRES	C	A + C	Σ A + C	T ₉ n	T ₉ Min	T ₉ Max	T ₉ In Hrs	T ₉ Ft	U	TYPICAL SECTION	S ₀ Ft	n	V. CALC Ft ³ Sec	WATER DEPTH	LINING DEPTH	TYPE LINING	REMARKS	



seeding. For the most part, the materials used are biodegradable. Listed below are some of the temporary linings that can be used, which are established in the charts for this section. Among the factors which should be known in order to use these are hydraulic radius, soil condition, and channel slope. When one or all of these factors are known, then a flow velocity or maximum flow depth can be determined from these charts.

1. *Fiber Glass Roving
2. *Jute Matting
3. *Wood Fiber

*Refer to the Arkansas Highway and Transportation Department's Standard Specifications for material descriptions and construction methods.

9.7.3 GRASS LINING

Several different types of vegetal covers are listed and grouped according to degree to retardance in Table 9-2. This table can be used in conjunction with seeding specifications in the Department's Standard Specifications, and Figures 9-14 through 9-21 determine flow velocities or maximum flow depths given such factors as channel slope, hydraulic radius, and/or soil types. Table 9-3 is relatively good source to check permissible velocities for different types of grass linings in channels.

9.7.4 ROCK RIPRAP

The resistance of random riprap to displacement by moving water depends upon:

1. Weight, size, shape and composition of the individual stones.
2. The gradation of the stone.
3. The depth of water over the stone blanket.
4. The steepness and stability of the protected slope and angle of repose of riprap.
5. The stability and effectiveness of the filter blanket on which the stone is placed.
6. The protection of toe and terminals of the stone blanket.

The size of stone needed to protect a streambank or highway embankment from erosion by a current moving parallel to the embankment is determined by the use of Figures 9-22, 9-23, and 9-24.

When rock riprap is used, the need for an underlying filter material must be evaluated. The filter material may be either a granular blanket or plastic filter cloth.

9.8 DESIGN OF GRANULAR FILTER BLANKET

For a granular filter blanket, the following criteria should be met:

$$\frac{D_{15} \text{ filter}}{D_{85} \text{ base}} < 5 < \frac{D_{15} \text{ filter}}{D_{15} \text{ base}} < 40$$

and

$$\frac{D_{50} \text{ filter}}{D_{50} \text{ base}} < 40$$

In the above relationships, filter refers to the overlying material and base refers to the underlying material. The relationships must hold between the filter blanket and base material and the riprap and filter blanket. Reference 12 contains a detailed procedure for the design of a filter blanket.

9.9 CONCRETE

Concrete lined channels provide high capacities, but also have high outlet velocities so erosion problems become evident and must be dealt with. Since no scour occurs in rigid linings for the velocities normally encountered in drainage design, no curves are necessary. Capacity Figures 9-25 through 9-30 related velocity and discharge to the channel geometry, slope and resistance. The Manning equation may be solved by trial and error by the trapezoidal channel charts.

TABLE 9-2

Classification of vegetal covers as to degree of retardance

Note: Covers classified have been tested in experimental channels. Covers were green and generally uniform.

Retardance	Cover	Condition
A	Weeping lovegrass.....	Excellent stand, tall, (average 30")
	Yellow bluestem Ischaemum.....	Excellent stand, tall, (average 36")
	Kudzu.....	Very dense growth, uncut
	Bermudagrass.....	Good stand, tall (average 12")
B	Native grass mixture (little bluestem, blue grama, and other long and short mid-west grasses).....	Good stand, unmowed
	Weeping lovegrass.....	Good stand, tall, (average 24")
	Lespedeza sericea.....	Good stand, not woody, tall (average 19")
	Alfalfa.....	Good stand, uncut, (average 12")
	Weeping lovegrass.....	Good stand, mowed, (average 12")
	Kudzu.....	Dense growth, uncut
	Blue grama.....	Good stand, uncut, (average 13")
	Crabgrass.....	Fair stand, uncut (10 to 48")
	Bermudagrass.....	Good stand, mowed (average 5")
	Common lespedeza.....	Good stand, uncut (average 11")
C	Grass-legume mixture--summer (orchard grass, redtop, Italian ryegrass, and common lespedeza).....	Good stand, uncut (6 to 8")
	Centipedegrass.....	Very dense cover (average 6")
	Kentucky bluegrass.....	Good stand, headed (6 to 12")
	Bermudagrass.....	Good stand, cut to 2.5" height
	Common lespedeza.....	Excellent stand, uncut (average 4.5")
D	Buffalograss.....	Good stand, uncut (3 to 6")
	Grass-legume mixture--fall, spring (orchard grass, redtop, Italian ryegrass, and common lespedeza).....	Good stand, uncut (4 to 5")
	Lespedeza sericea.....	After cutting to 2" height Very good stand before cutting
	Bermudagrass.....	Good stand, cut to 1.5" height
E	Bermudagrass.....	Burned stubble

From SCS "Handbook of Channel Design for Soil and Water Conservation"

TABLE 9-3

PERMISSIBLE VELOCITIES FOR CHANNELS LINED WITH GRASS*

Cover	Slope range, %	Permissible velocity, fps	
		Erosion-resistant soils	Easily eroded soils
Bermuda grass	0-5	8	6
	5-10	7	5
	>10	6	4
Buffalo grass, Kentucky bluegrass, smooth brome, blue grama	0-5	7	5
	5-10	6	4
	>10	5	3
Grass mixture	0-5	5	4
	5-10	4	3
Do not use on slopes steeper than 10%			
Lespedeza sericea, weeping love grass, ischaemum, yellow blue-stem, kudzu, alfalfa, crabgrass	0-5	3.5	2.5
	Do not use on slopes steeper than 5%, except for side slopes in a combination channel		
Annuals--used on mild slopes or as temporary protection until permanent covers are established, common lespedeza, Sudan grass	0-5	3.5	2.5
	Use on slopes steeper than 5% is not recommended		

REMARKS: The values apply to average, uniform stands of each type of cover. Use velocities exceeding 5 fps only where good covers and proper maintenance can be obtained.

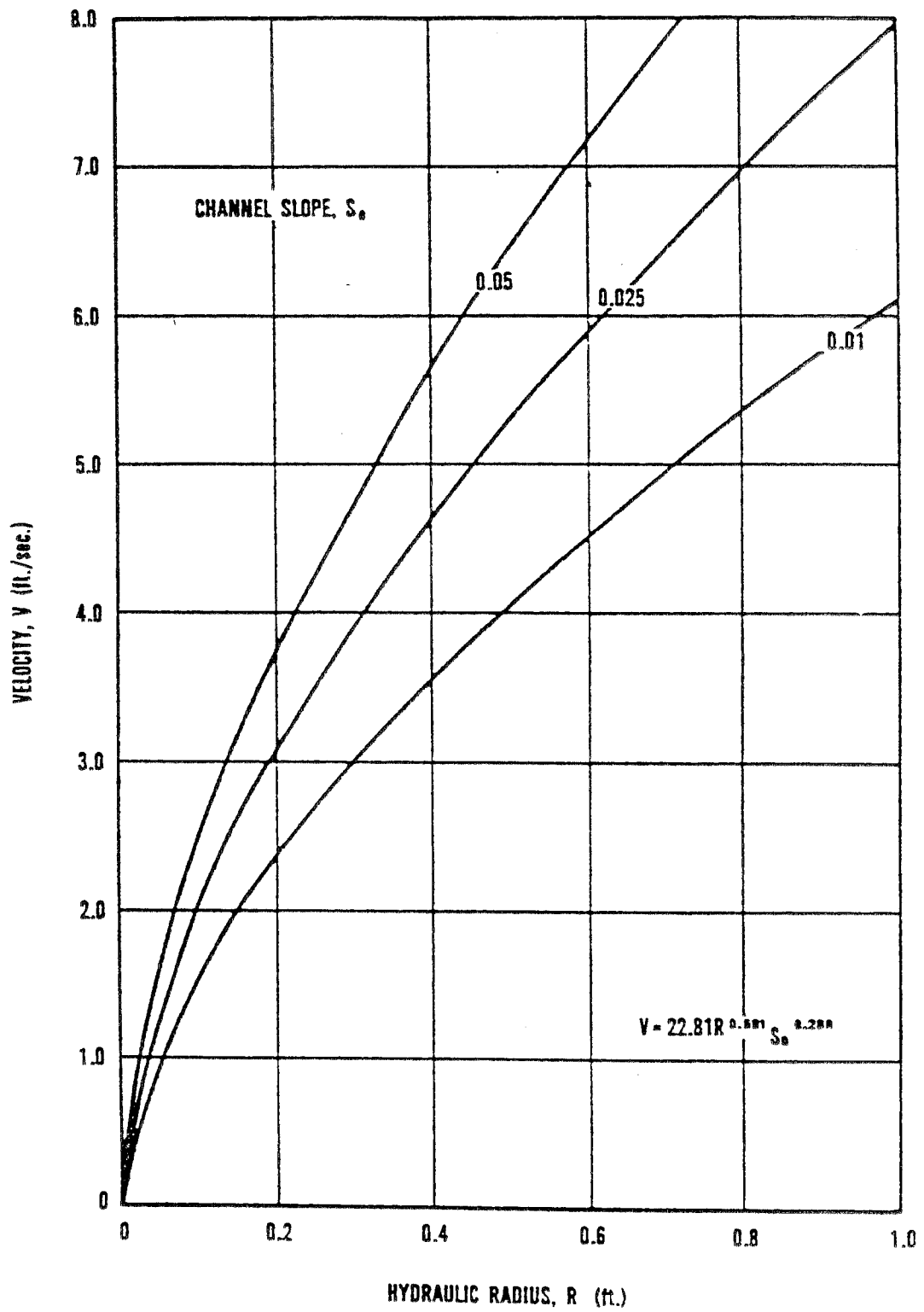

FLOW VELOCITY FOR UNLINED CHANNELS (BARE SOIL)

SOURCE: AHTD

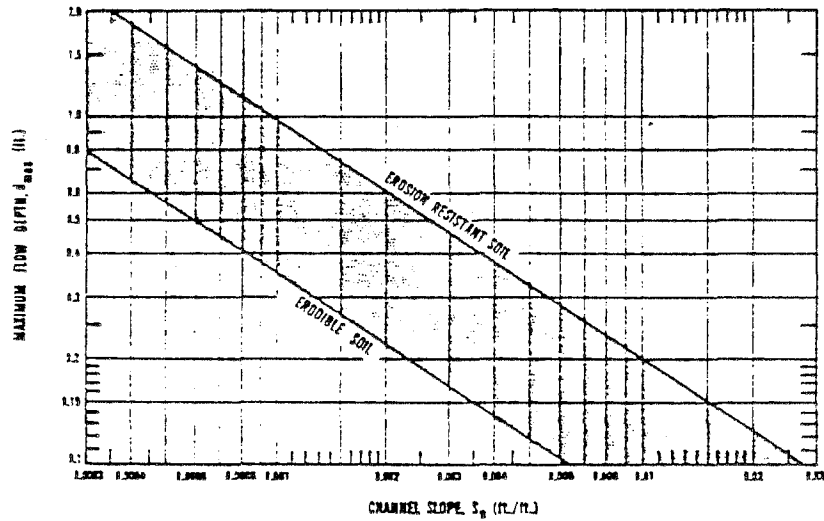

MAXIMUM PERMISSIBLE DEPTH OF FLOW (d_{max}) FOR UNLINED CHANNELS (BARE SOIL)

9-4

FIGURE

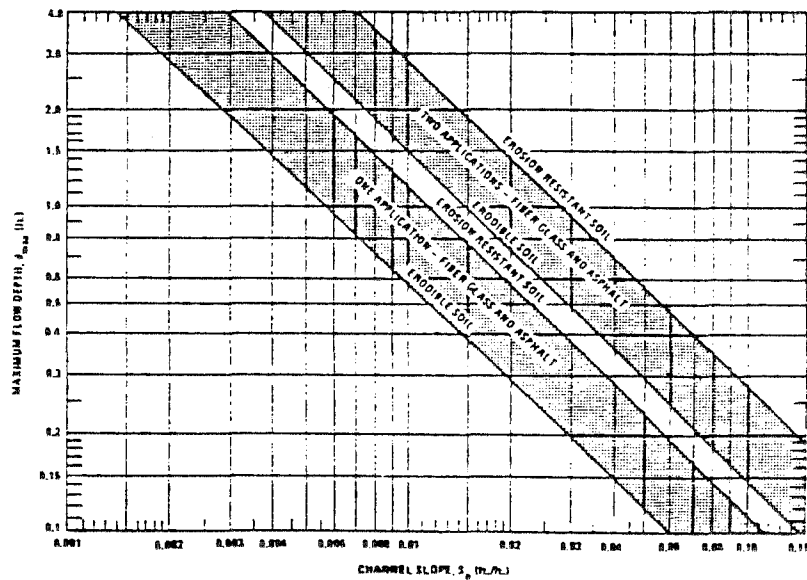

MAXIMUM PERMISSIBLE DEPTH OF FLOW (d_{max}) FOR CHANNELS LINED WITH FIBER GLASS ROVING (SINGLE AND DOUBLE LAYER)

9-5

FIGURE

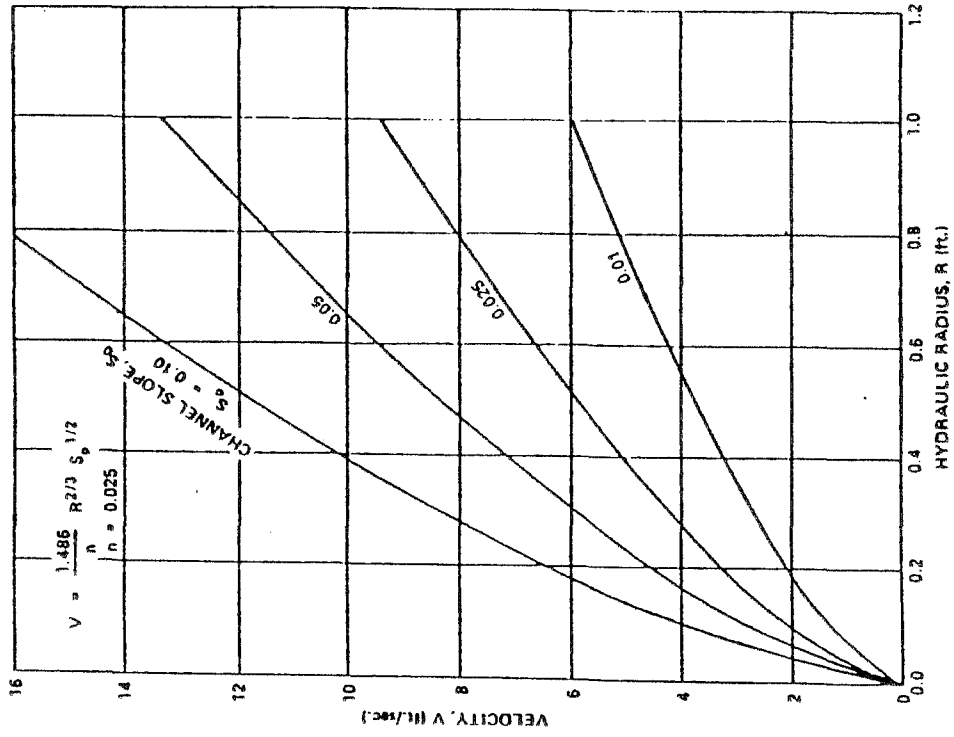

Flow Velocity for Channels Lined with Fiber Glass Roving
Tacked with Asphalt, Double Layer

9-7

FIGURE

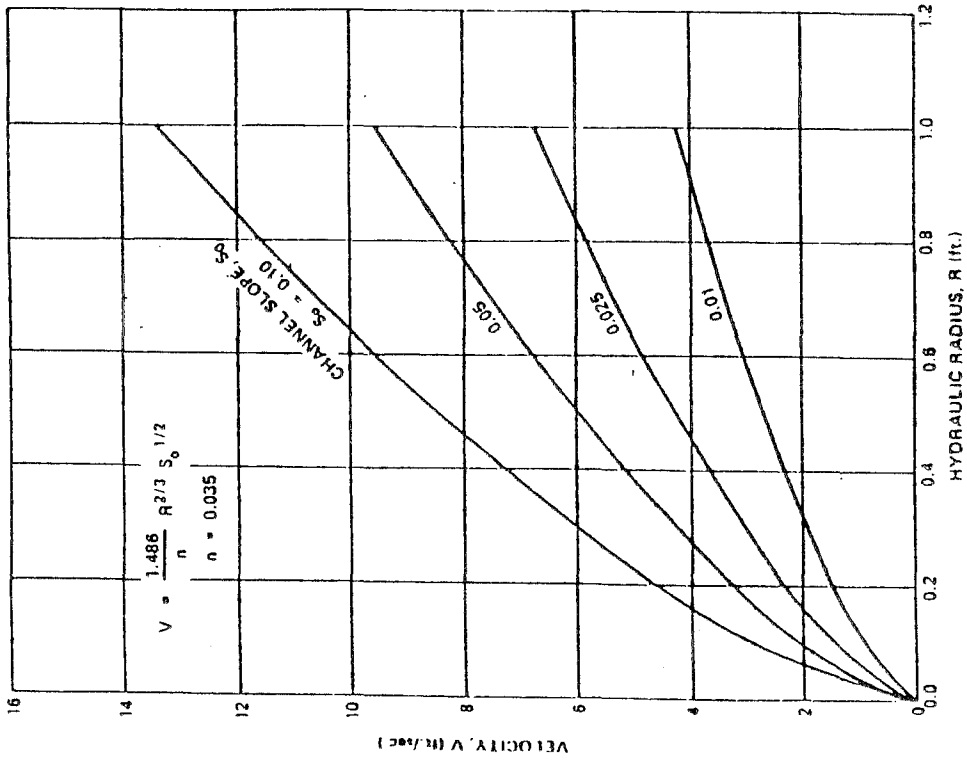

Flow Velocity for Channels Lined with Fiber Glass Roving
Tacked with Asphalt, Single Layer

9-6

FIGURE

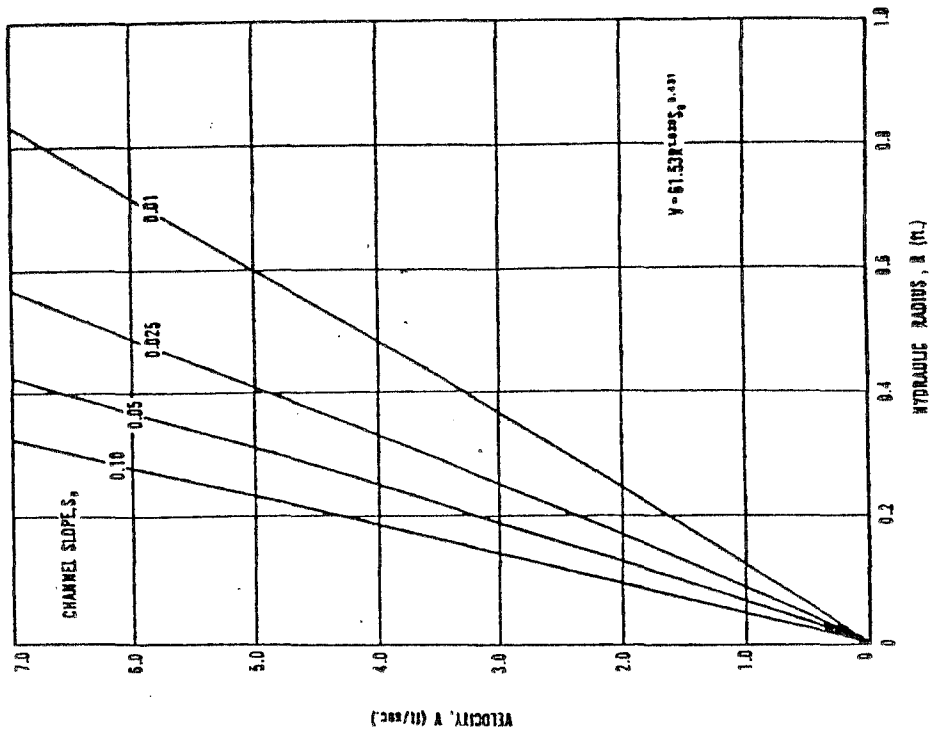

FLOW VELOCITY FOR CHANNELS LINED WITH JUTE MESH

9-9
FIGURE

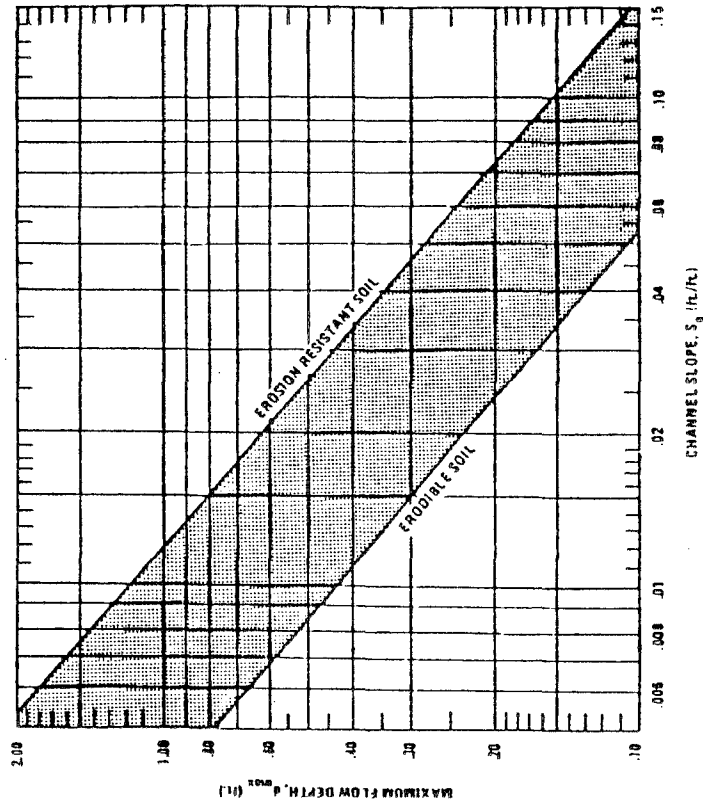

MAXIMUM PERMISSIBLE DEPTH OF FLOW (d_{max}) FOR CHANNELS LINED WITH JUTE MESH

9-8
FIGURE

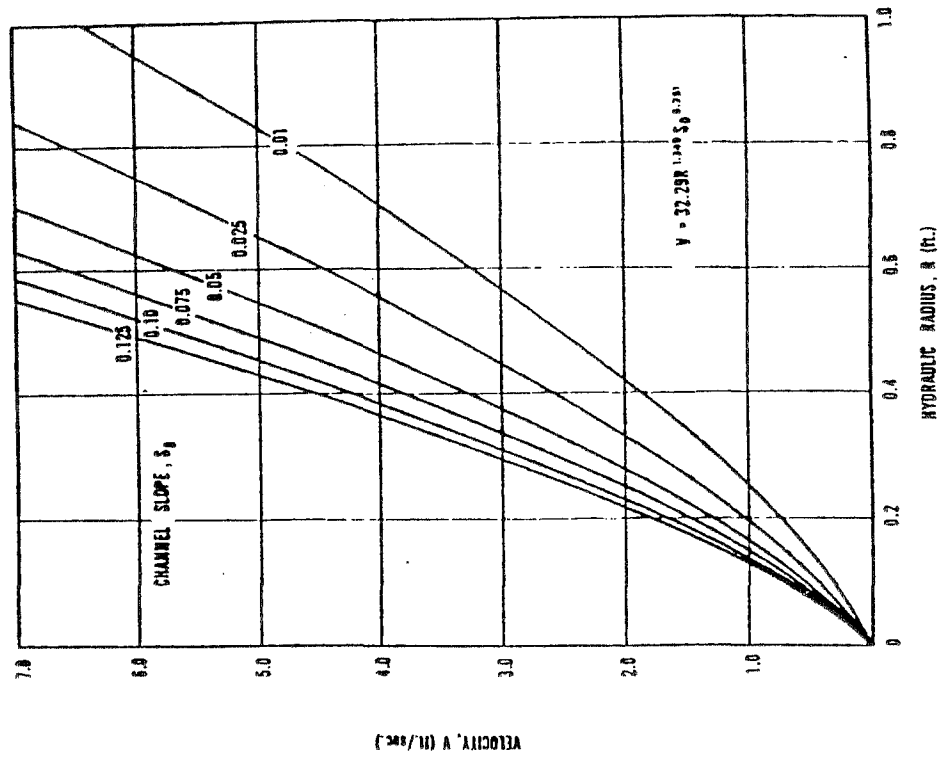

FLOW VELOCITY FOR CHANNELS LINED WITH EXCELSIOR MAT

9-11
FIGURE

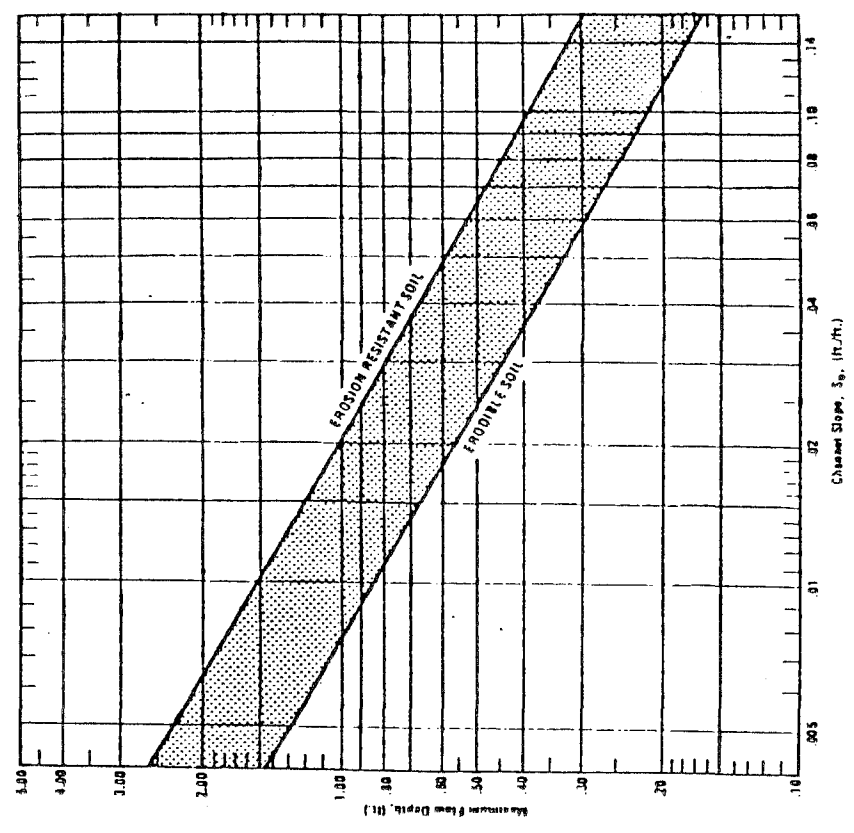

MAXIMUM PERMISSIBLE DEPTH OF FLOW (d_{max}) FOR CHANNELS LINED WITH EXCELSIOR MAT

9-10
FIGURE

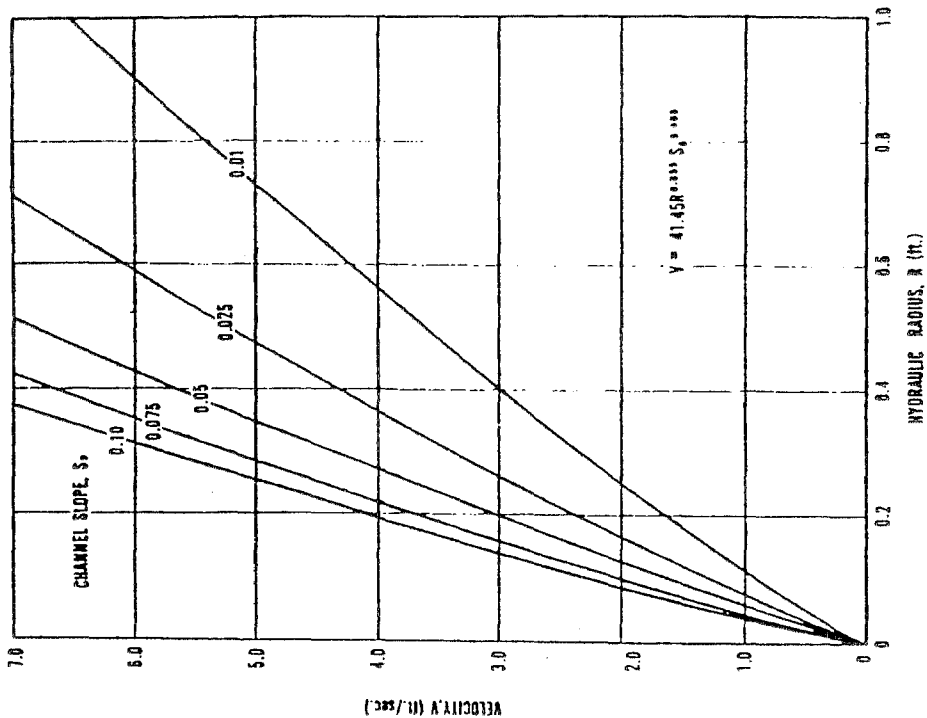

FLOW VELOCITY FOR CHANNELS LINED WITH EROSIONNET

9-13

FIGURE

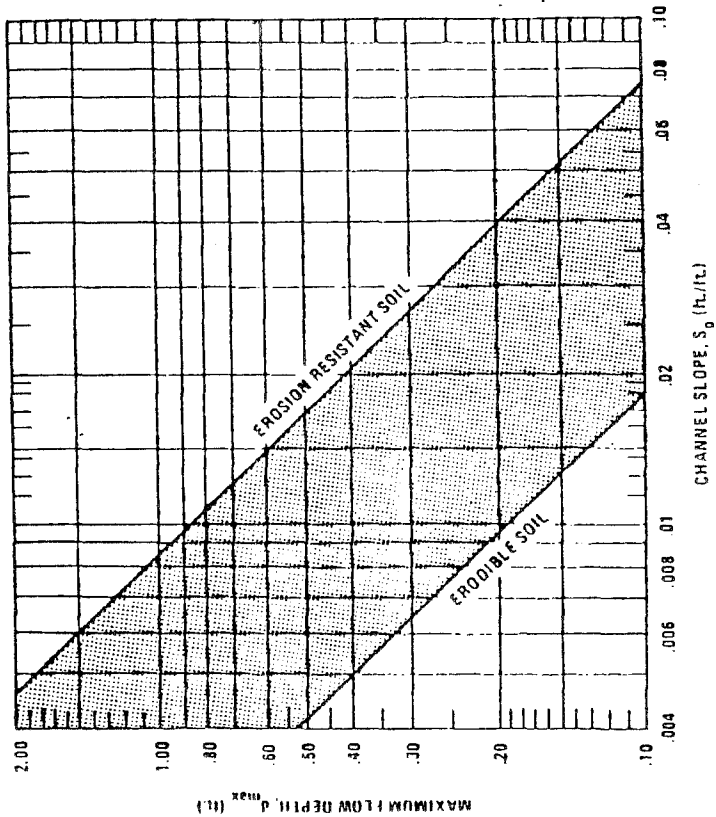

MAXIMUM PERMISSIBLE DEPTH OF FLOW (d_{max}) FOR CHANNELS LINED WITH EROSIONNET

9-12

FIGURE

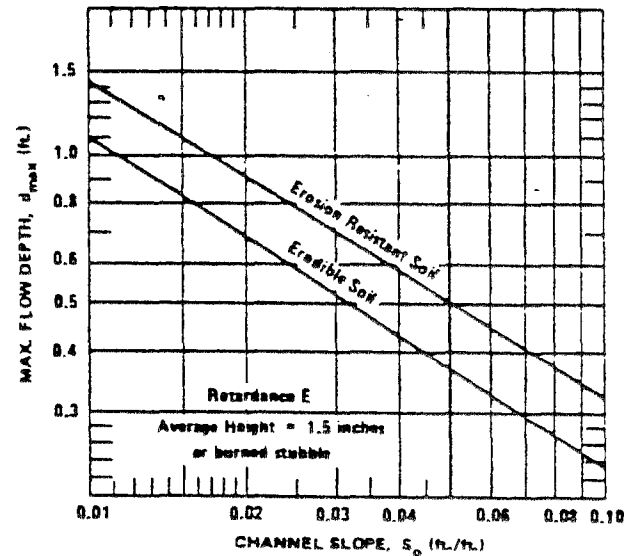
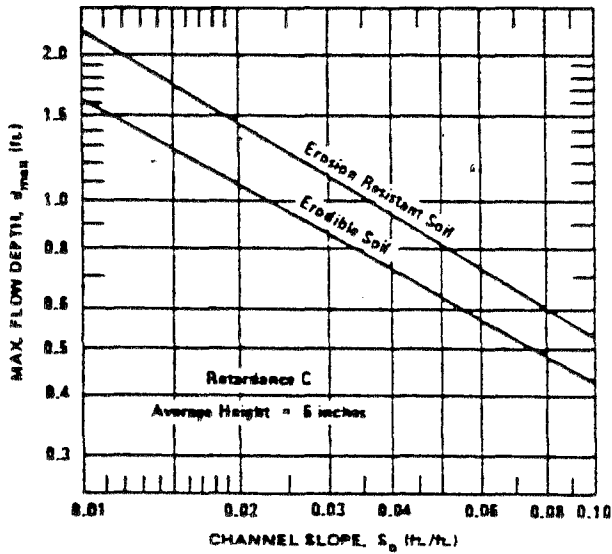
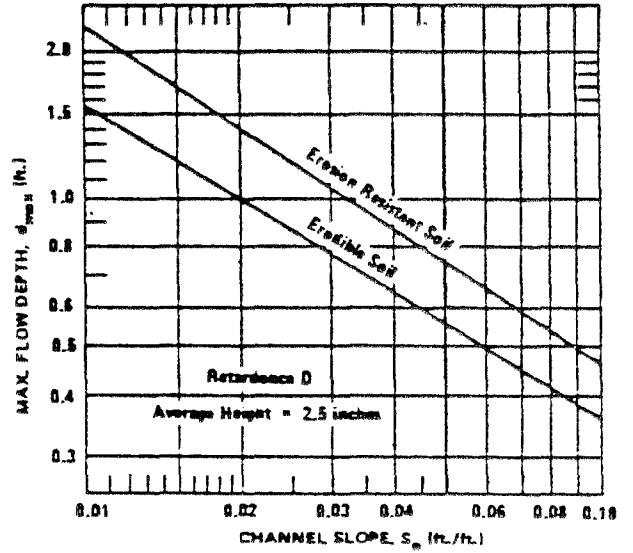
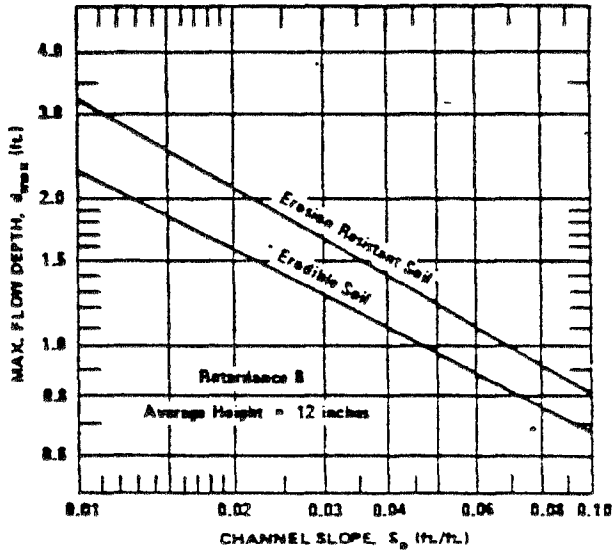

MAXIMUM PERMISSIBLE DEPTH OF FLOW (d_{max}) FOR CHANNELS LINED WITH BERMUDA GRASS, GOOD STAND, CUT TO VARIOUS LENGTHS

Note: Use on slopes steeper than 10 percent is not recommended

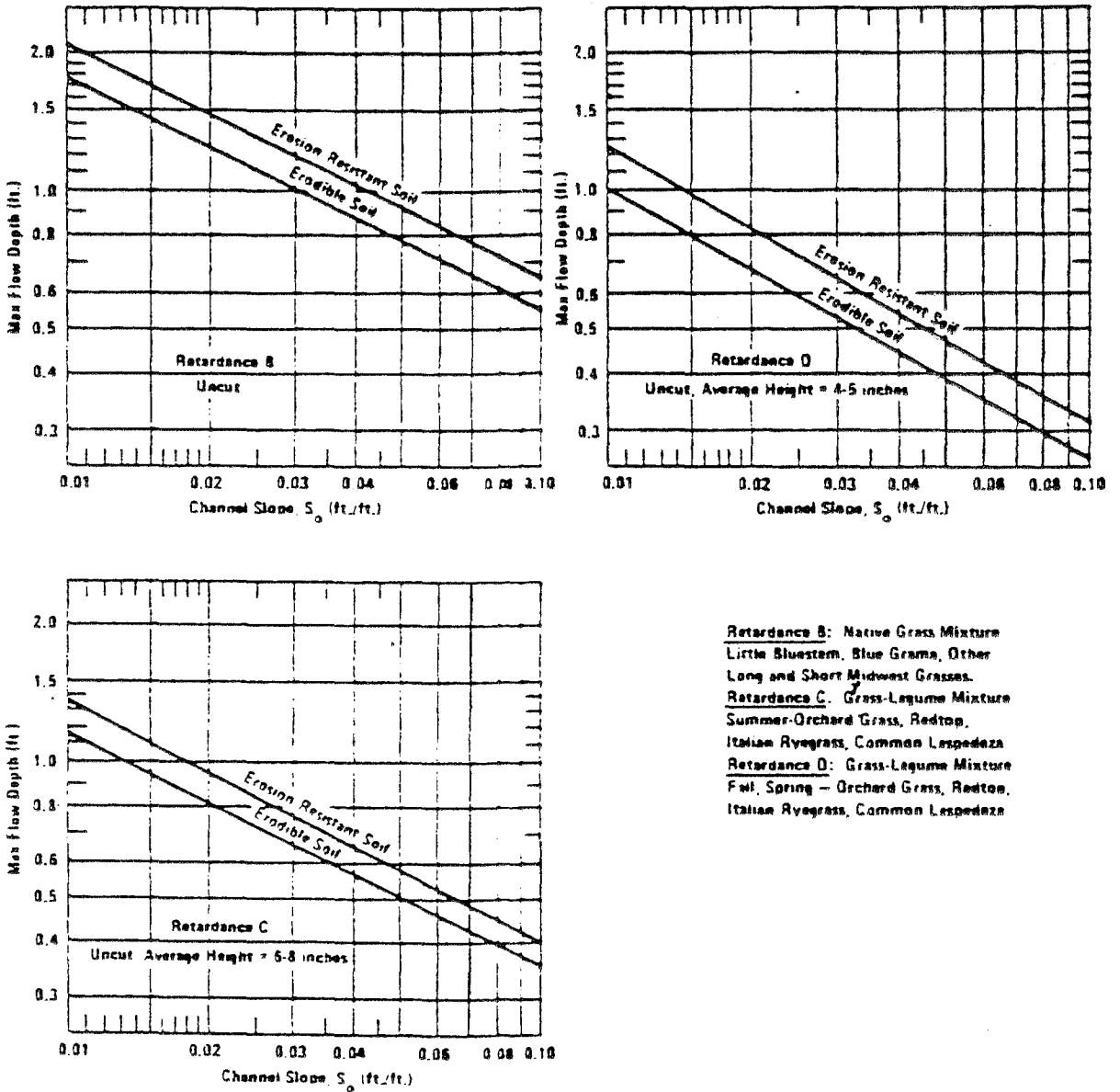

Retardance B: Native Grass Mixture
 Little Bluestem, Blue Grama, Other
 Long and Short Midwest Grasses.
Retardance C: Grass-Legume Mixture
 Summer-Orchard Grass, Redtop,
 Italian Ryegrass, Common Lespedeza
Retardance D: Grass-Legume Mixture
 Fall, Spring - Orchard Grass, Redtop,
 Italian Ryegrass, Common Lespedeza

Maximum Permissible Depth of Flow (d_{max}) for Channels Lined with Grass Mixtures. Good Stand, Uncut

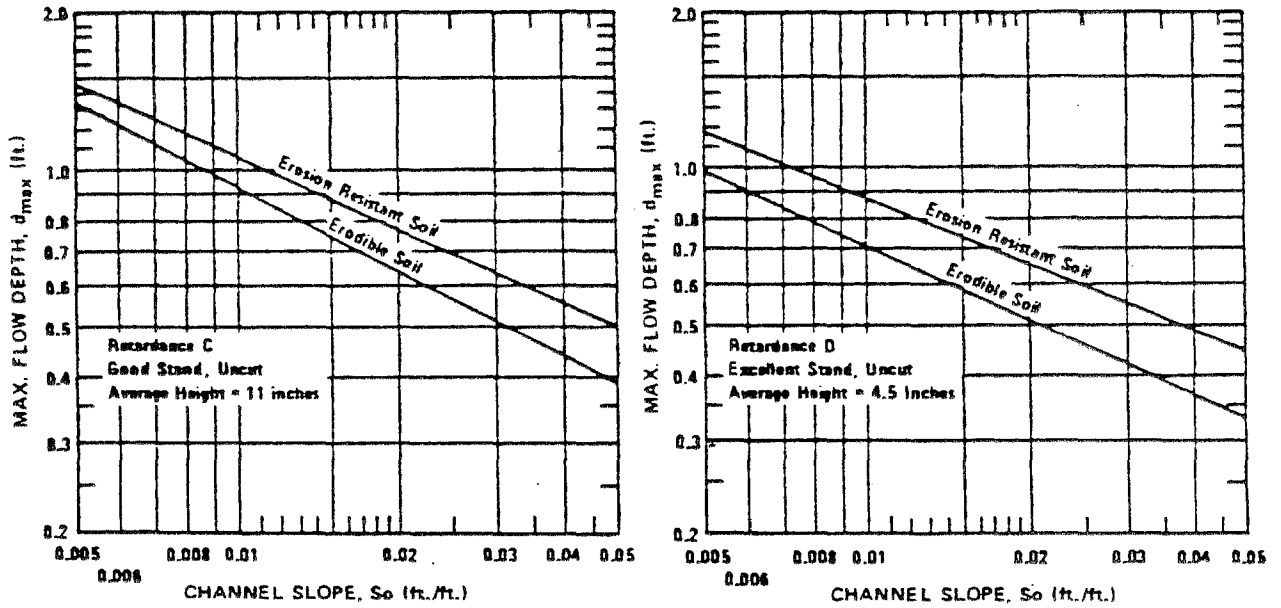

MAXIMUM PERMISSIBLE DEPTH OF FLOW (d_{max}) FOR CHANNELS LINED WITH COMMON LESPEDEZA OF VARIOUS LENGTHS

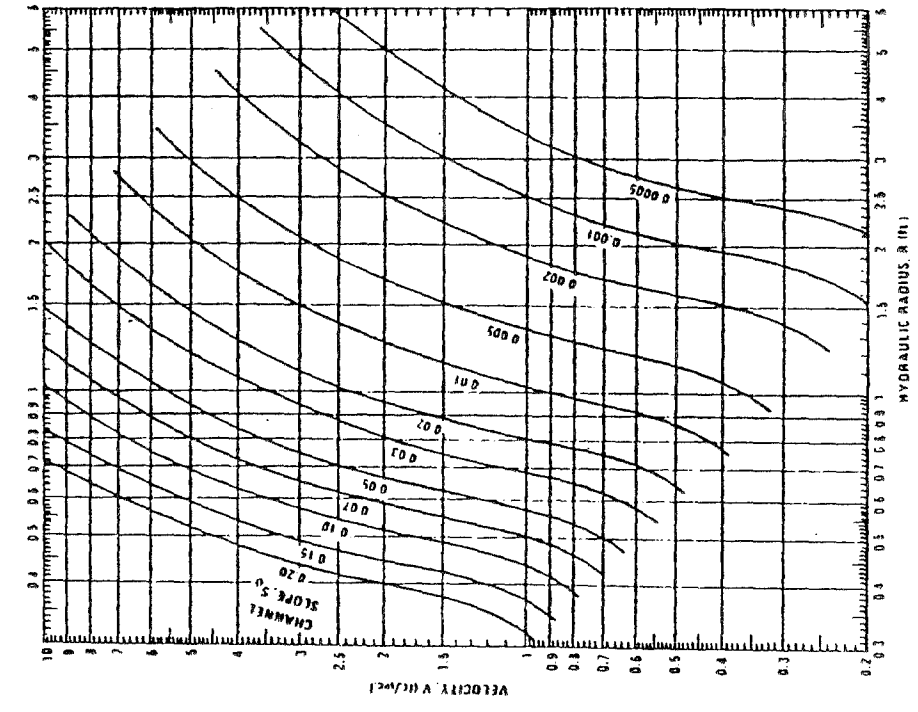

Flow Velocity for Channels Lined with Vegetation of Retardance B

9-18
FIGURE

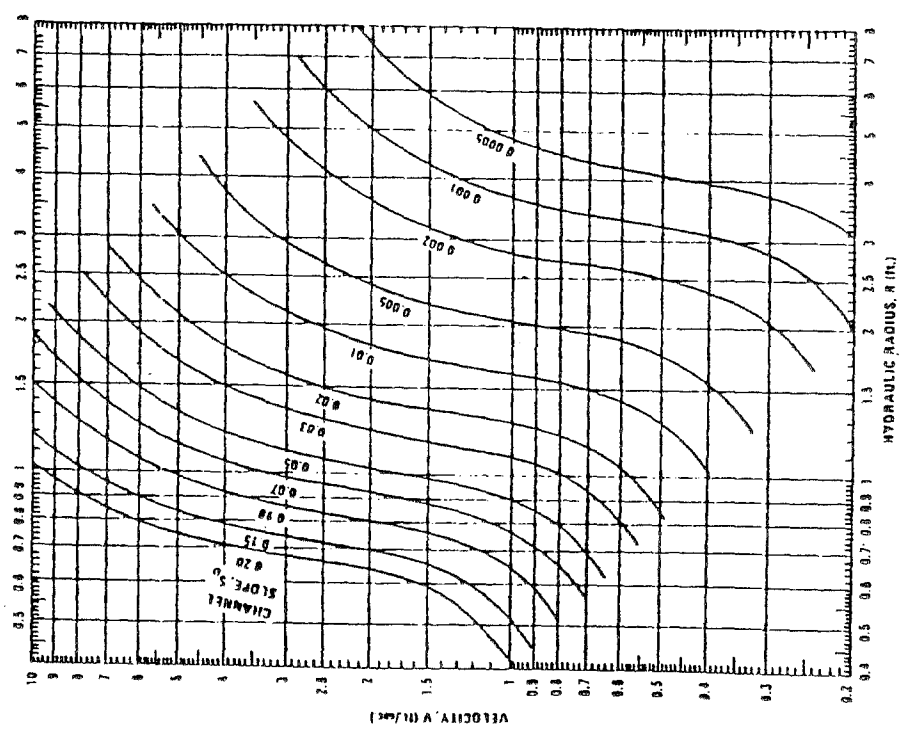

Flow Velocity for Channels Lined with Vegetation of Retardance A

9-17
FIGURE

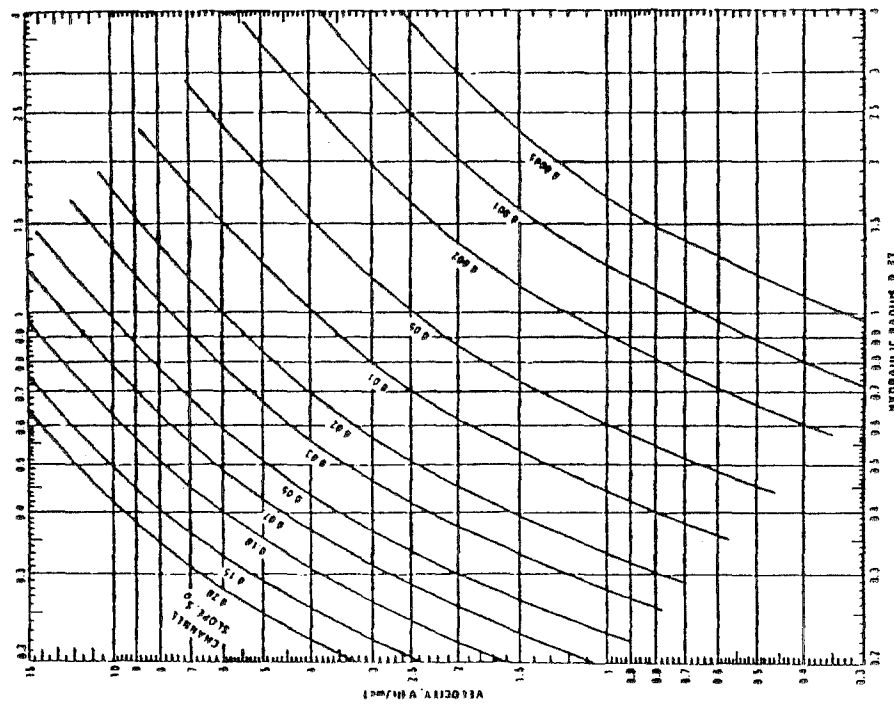

Flow Velocity for Channels Lined with Vegetation of Retardance D

9-20
FIGURE

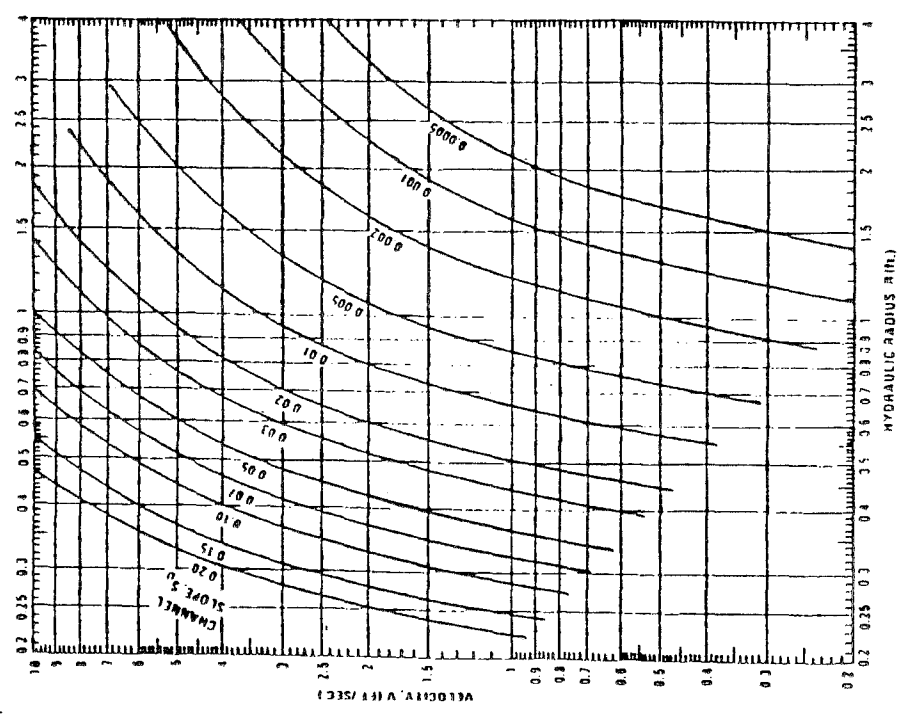

Flow Velocity for Channels Lined with Vegetation of Retardance C

9-19
FIGURE

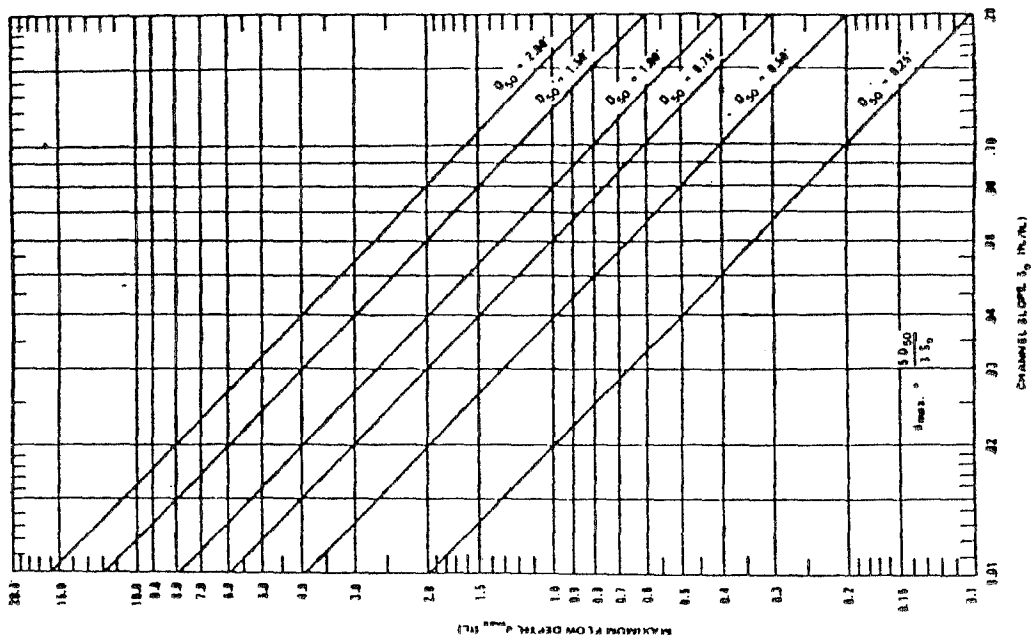

MAXIMUM PERMISSIBLE DEPTH OF FLOW (d_{max})
FOR CHANNELS LINED WITH ROCK RIPRAP

9-21
FIGURE

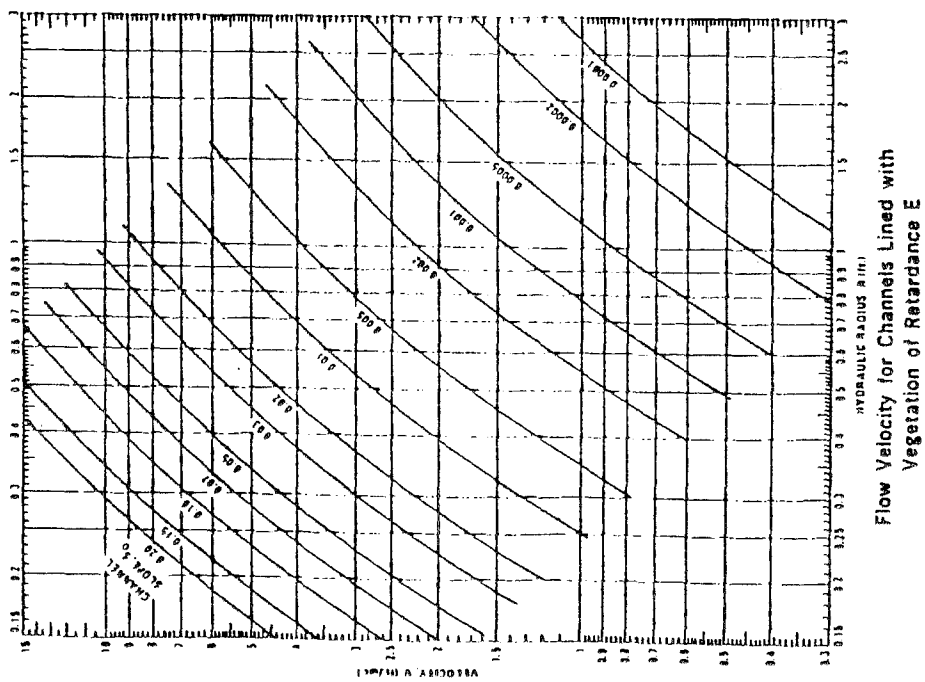

Flow Velocity for Channels Lined with
Vegetation of Retardance E

9-22
FIGURE

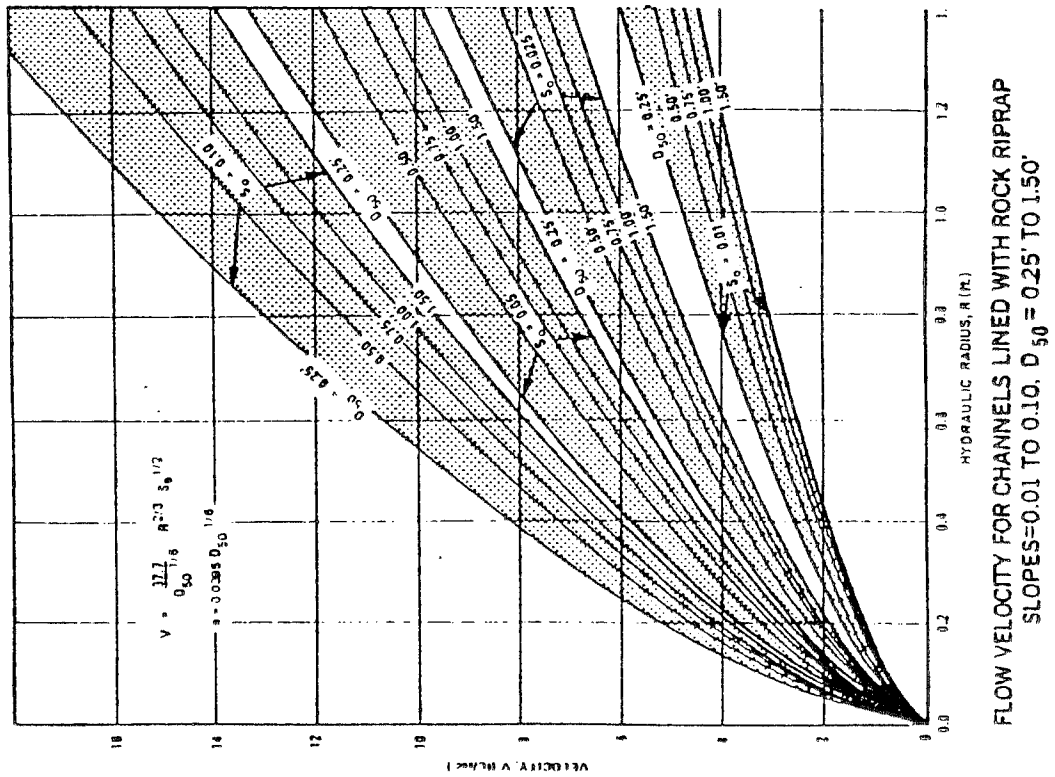
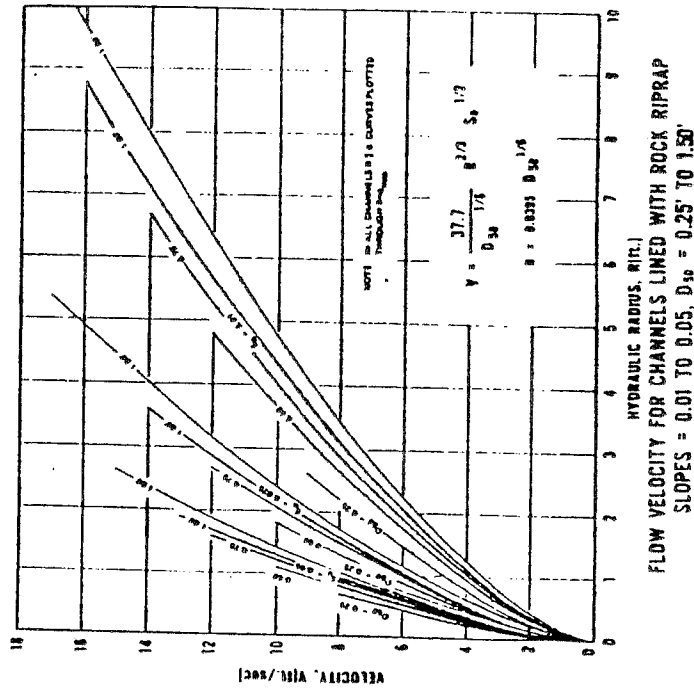

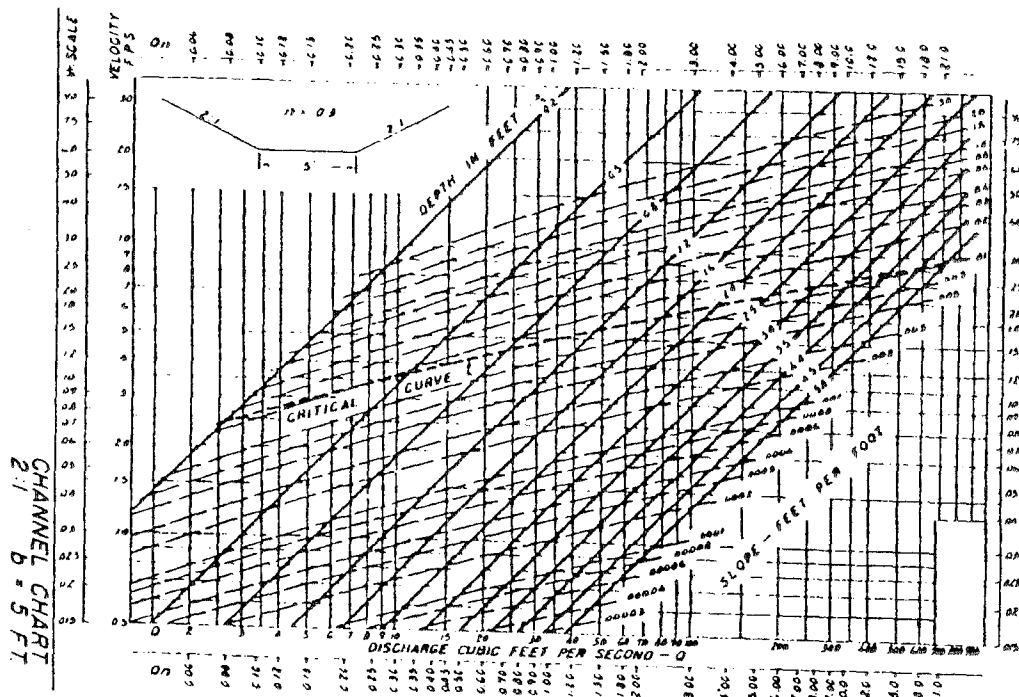
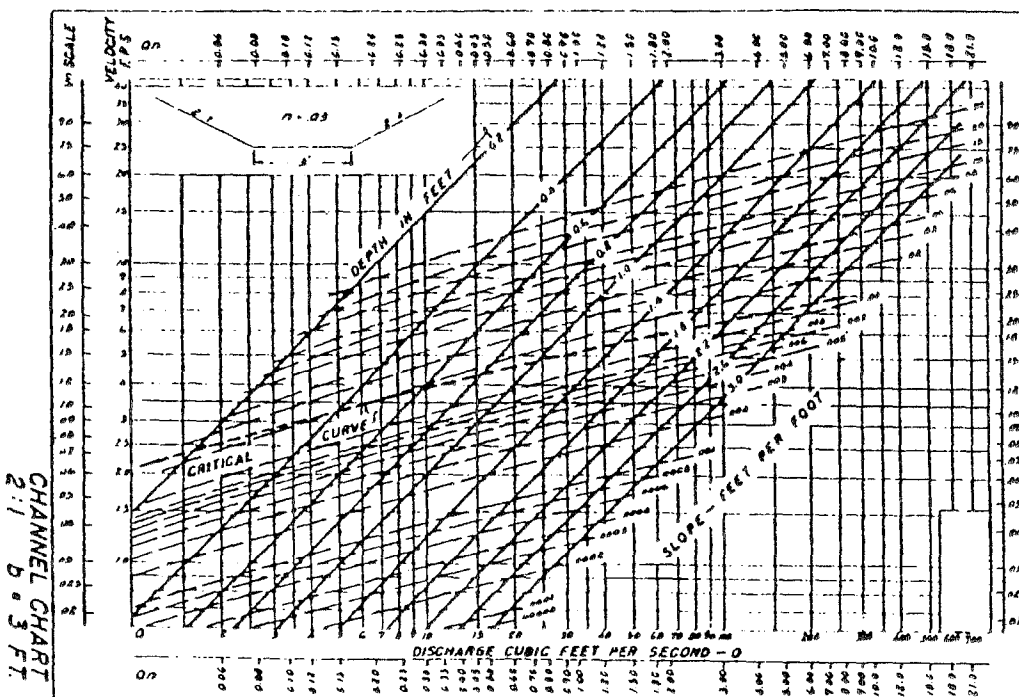

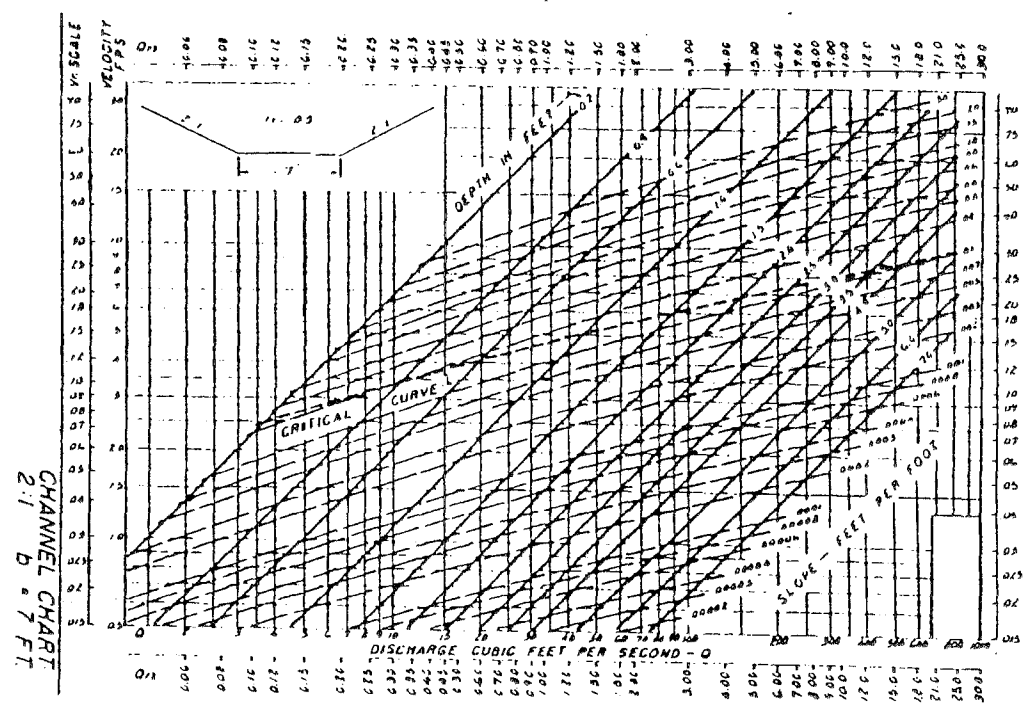
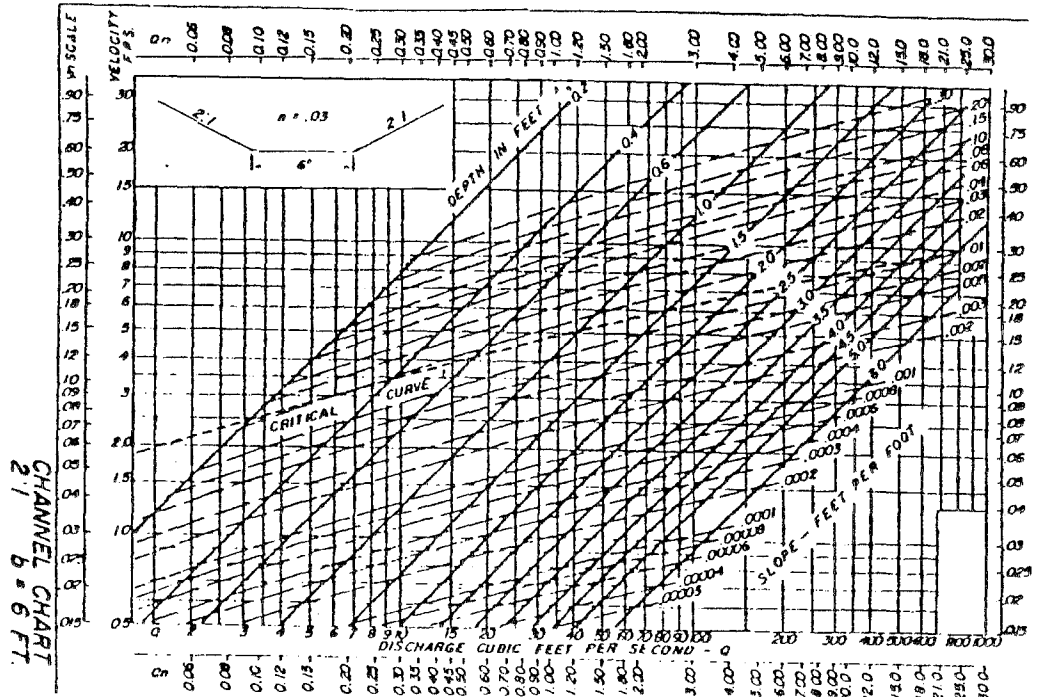

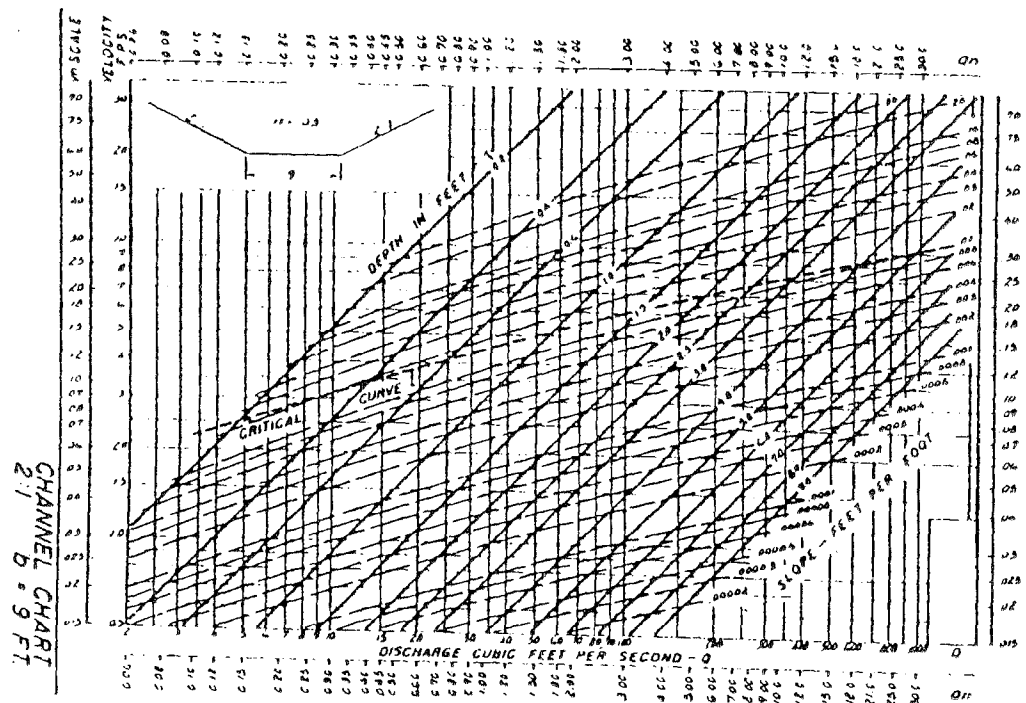
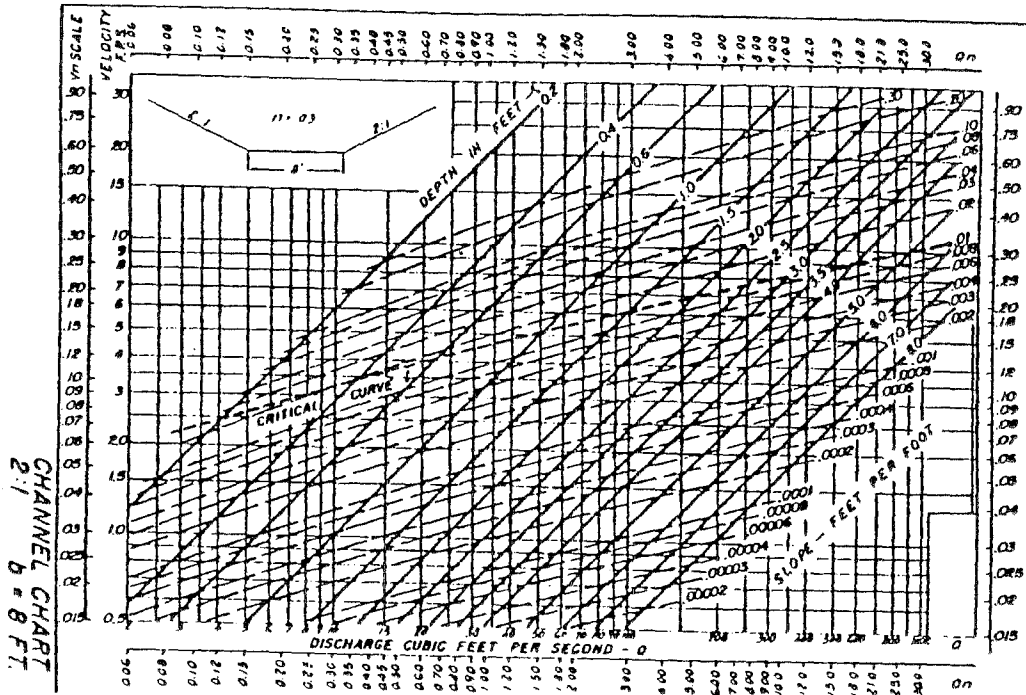

9-27
FIGURE

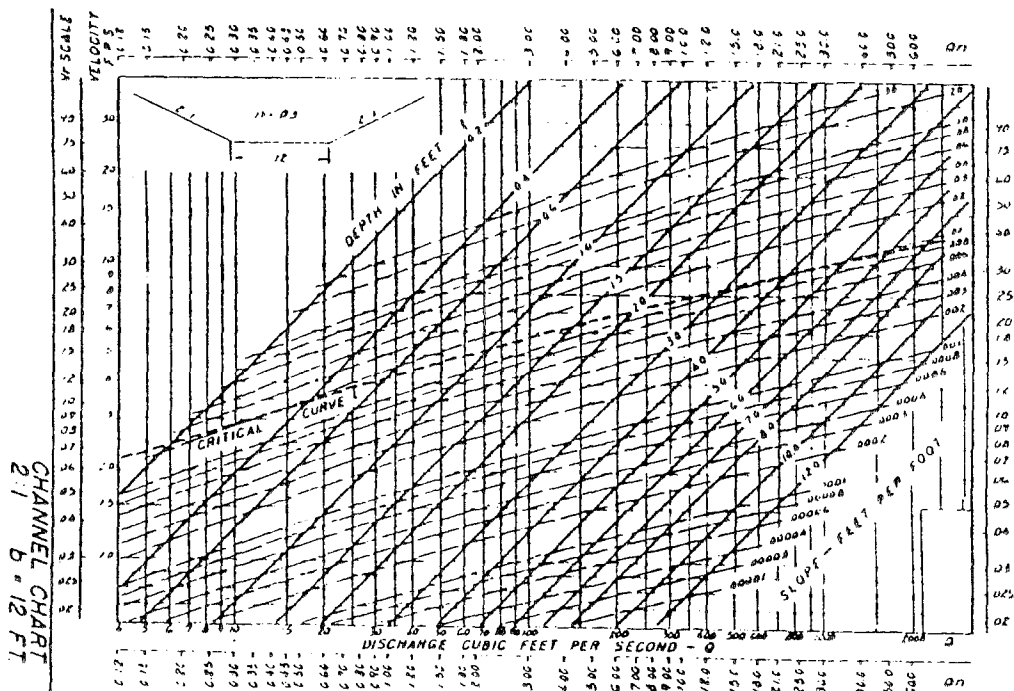
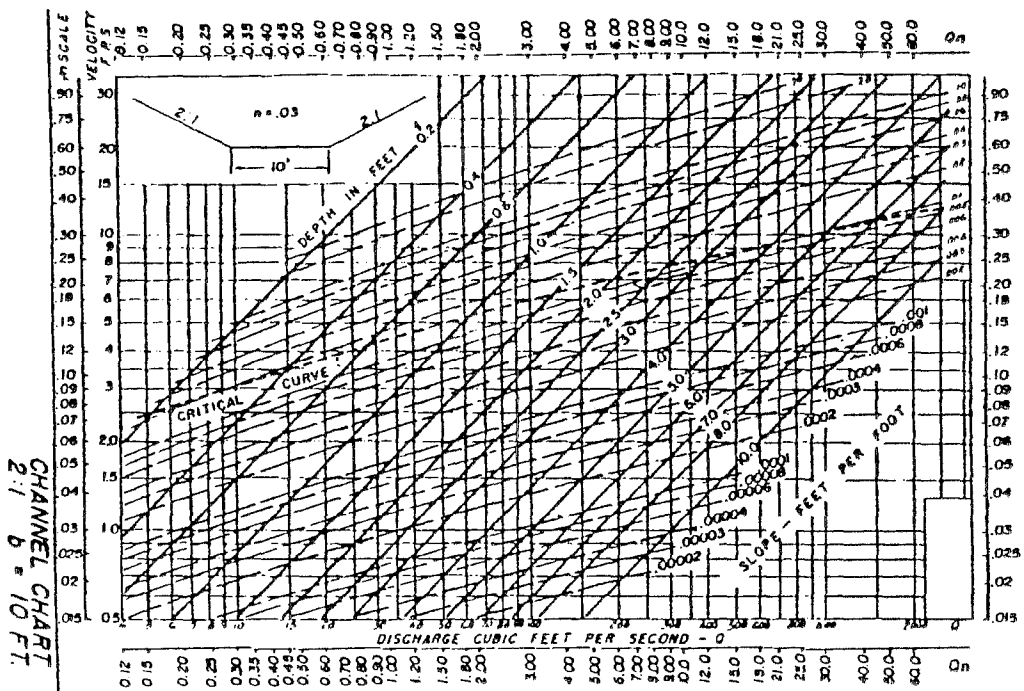

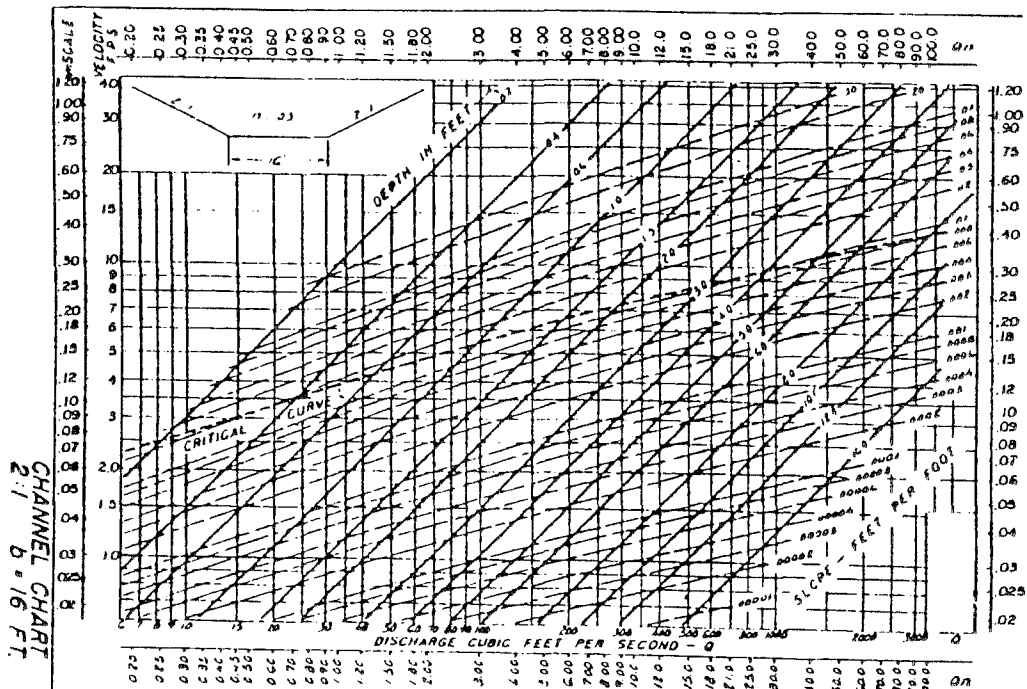
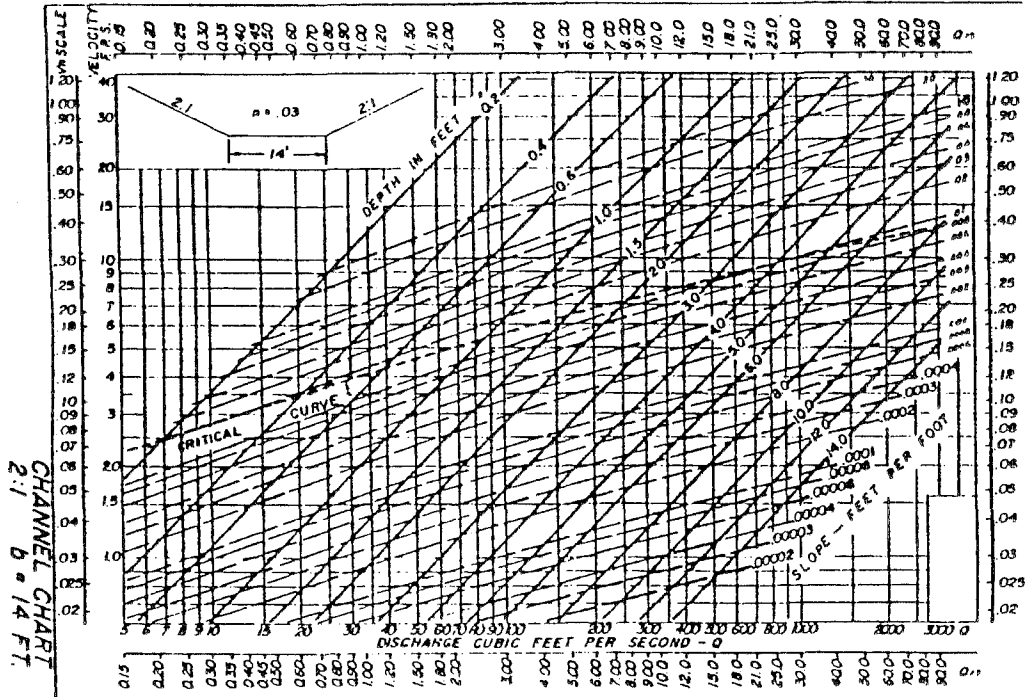

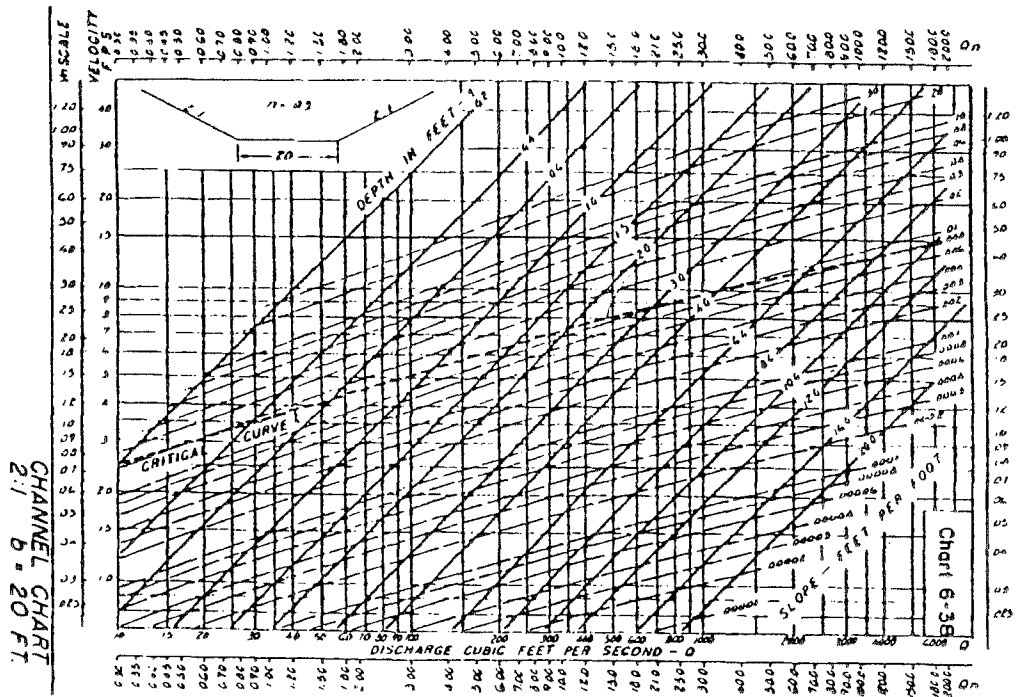
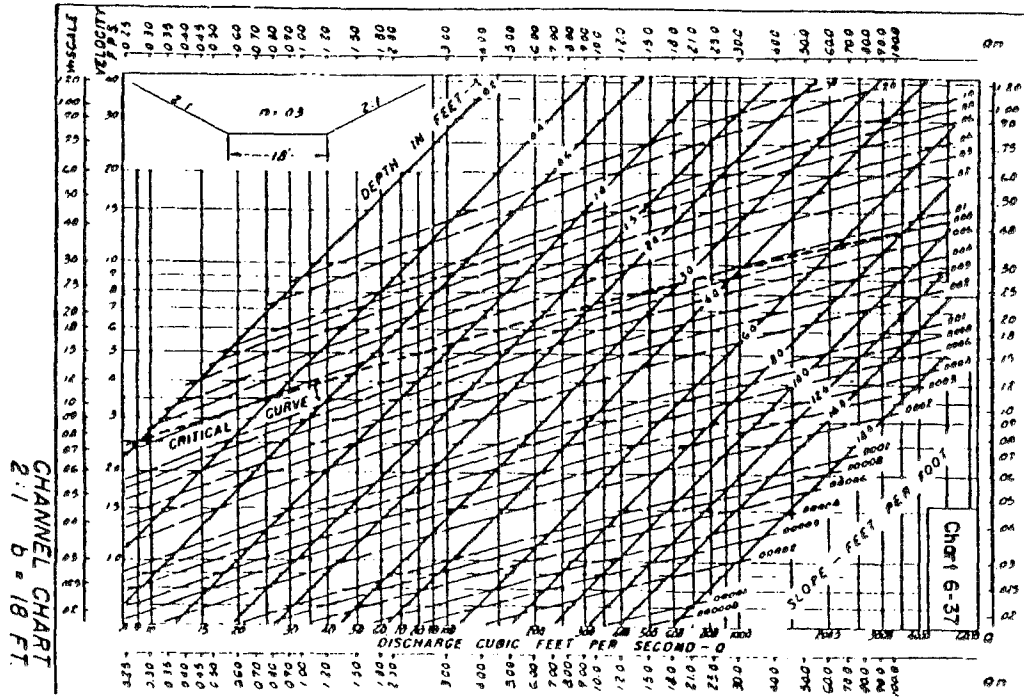

SECTION X - EROSION AND SEDIMENT CONTROL

10.1	General	2
	1. Purpose	
	2. Grading and Drainage Plans	
	3. Sketch Grading & Drainage Plan Requirements	
	4. Complete Grading & Drainage Plan Requirements	
	5. Other Permitting Requirements	
10.2	Stabilization Practices	9
	1. Chemical Stabilization	
	2. Filter Strips	
	3. Permanent Seeding and Planting	
	4. Preservation of Natural Vegetation	
	5. Sod Stabilization	
	6. Stream Bank Stabilization	
	7. Subsurface Drain	
	8. Temporary Seeding	
10.3	Erosion Control Methods	12
	1. Buffer Zone	
	2. Diversion Dike	
	3. Drainage Swale	
	4. Geotextiles	
	5. Gradient Terrace	
	6. Interceptor Dike and Swale	
	7. Mulching	
	8. Outlet Protection	
	9. Pipe Slope Drain	
	10. Surface Roughening	
10.4	Siltation and Sediment Control	16
	1. Check Dams	
	2. Gravel or Stone Filter Berm	
	3. Silt Fence	
	4. Sediment Trap	
	5. Storm Drain inlet Protection	
	6. Temporary Sediment Basin	
	7. Temporary Storm Drain Diversion	
10.5	Other Erosion and Sediment Controls	19
	1. Dust Control	
	2. Hazardous Products	
	3. Off-Site Vehicle Tracking of Sediment	
	4. Waste Disposal	
10.6	Design of Erosion and Sediment Control Methods	21
	1. Soil Loss Calculations	
	2. Erosion Controls - Example #1	
	3. Siltation and Sediment Controls - Example #2	
10.7	Appendices	38
	A. Grading and Drainage Plan Checklist	
	B. Soil Loss Calculation Tables	
	C. Erosion & Sediment Control Illustrations	
	D. References	

10.1 GENERAL

1. Purpose

Construction activities produce many kinds of pollutants which can cause water quality problems. Grading activities remove grass, rocks and other protective covers from the land surface, resulting in the exposure of underlying soil to the elements. Because the land surface is unprotected, soil and sand particles are easily picked up by wind or washed away by rain. This process is called erosion.

The water, carrying soil and sand particles picked up by site runoff, eventually reaches the municipal storm sewer system. It is then transported on to area streams and ponds. When the water slows down, particles fall onto the bottom of the pipes, stream beds or ponds. This process is called sedimentation. Gradually, layers of these clays and silts build up in the storm drainage system, choking streams and ponds and covering areas where fish spawn and plants grow.

In addition to erosion and sedimentation, construction activities often require the use of toxic or hazardous materials such as petroleum products and fuels, pesticides, herbicides, fertilizers, asphalt, concrete and sealants. These types of materials often contain small amounts of toxic substances which may harm human, plant and animal life along receiving streams and within lakes and ponds.

Management practices which control erosion and sedimentation fall into three main types; those which divert runoff from construction areas, those which prevent erosion on the construction site, and those which trap sediment before it can leave the construction site. The use of management practices in this way is called storm water management, or sediment and erosion control.

This section of the Stormwater Management and Drainage Manual provides information on many management practices and controls which can be used to comply with the conditions of a grading permit. While specific practices are identified, careful consideration must be given to selecting the most appropriate management practices based upon site-specific conditions, and installing controls in a timely and proper manner. It also must be noted that proper maintenance is required on controls in order for them to remain effective.

10.1 GENERAL - Continued

2. Grading and Drainage Plans

Municipal Code provides that any person proposing to engage in grading, clearing, filling, cutting, quarrying, construction or similar activities regulated by this article shall apply to the City Engineer for approval of plans and issuance of a grading permit.

There are several exceptions to grading permit requirements, and these exceptions are considered by the City Engineer during Grading and Drainage Plan review. There are no exceptions to the need to prepare and submit a Grading and Drainage Plan. Proposed development which does not meet the criteria for a Grading and Drainage Plan, as set forth in the following paragraphs, must include certification from the Architect and/or Engineer that the criteria are not applicable to the proposed development. Failure to provide certification will result in the plan being rejected by the City Engineer.

A Grading and Drainage Plan is required for any of the following activities:

- a.) cut or fill activity greater than fifteen (15) vertical feet in height; or,
- b.) cut or fill volume equal to or greater than three thousand (3,000) cubic yards; or,
- c.) clearing that exceeds one (1) acre in size; and,
- d.) any land alteration on properties that are located within the 100-year floodplain boundary.

The Grading and Drainage Plan is submitted to and reviewed by the City Engineer to determine if a Grading Permit is required. Where vertical cut or fill activity greater than thirty (30) feet is indicated, Planning Commission approval is required. It should be noted that all construction work must include appropriate drainage and erosion control measures, regardless of whether a grading permit is required.

10.1 GENERAL - Continued

2. Grading and Drainage Plans - Continued

The Universal Soil Loss Equation has been adopted by the City of Little Rock to enable planners and developers to predict the average rate of soil erosion from construction sites. The City has established an allowable rate of soil loss at five tons per acres per year (5 t/a/yr). Grading plan development requires the application of the Universal Soil Loss Equation to determine the potential soil erosion from a site, which establishes the need for erosion controls. Once erosion controls are identified, the Universal Soil Loss Equation can be used to estimate the effectiveness and adequacy of erosion controls.

Where controls, alone or in combination, can not reduce the estimated average rate of soil erosion to at or below the allowable five tons per acre per year, controls are required to be placed such that they will reduce erosion to the maximum extent practicable.

The application of erosion and sedimentation controls falls within the sequence of: design; stabilization practices; erosion controls; sedimentation controls; and other controls, as applicable. It is possible to control site runoff with stabilization practices alone, where stabilization can reduce the potential soil loss from the site to at or below five (5) tons per acre per year. Where stabilization can not reduce the potential soil loss to at or below the allowable limit, then erosion controls are also required. Where a combination of stabilization practices and erosion controls are not effective in reducing potential soil loss, sedimentation controls are also required.

10.1 GENERAL - Continued

3. Sketch Grading and Drainage Plan Requirements

A Sketch Grading and Drainage Plan may be submitted for agricultural land uses or forestry activities on land owned by forest-related industry. A Sketch Plan is required as a part of the Planning Commission Application for any of the activities identified in part 10.1.2 above, and also for planned unit developments, conditional use permits, site plan reviews, subdivision approvals, or multiple building site approvals.

A Sketch Plan must identify the following:

- a.) acreage of the proposed project,
- b.) land areas to be disturbed, (hatching or shading)
- c.) stages of grading which identify the limits of sections to be disturbed and the approximate order of development,
- d.) extent of cut and fill, shown by placing a dashed line at the top and toe of cut or fill slopes, and indicating on the Plan the height and slope of the cut or fill,
- e.) provisions for collecting and discharging surface water, and,
- f.) erosion and sediment control measures, including structural and vegetative measures.

The Sketch Plan requires the seal and signature of a registered engineer, architect or landscape architect certifying that the Sketch Plan complies with Municipal Code. Plans for areas of less than five (5) acres where vertical cut or fill height does not exceed fifteen (15) feet, or where only tree clearing activities will take place may be prepared by a contractor or the property owner.

A Grading and Drainage Plan Checklist has been prepared and is included in Appendix A at the end of this section. Refer to Section 10.1.5 for information on other local, state and federal permitting requirements.

10.1 GENERAL - Continued

4. Complete Grading and Drainage Plan Requirements

A Complete Grading and Drainage Plan includes the requirements for a Sketch Plan and the following additional information:

- a.) a vicinity drawing identifying property lines, existing or platted streets and public ways within or immediately adjacent to the site,
- b.) location of all known existing sewers, water mains, culverts, underground utilities, and existing permanent buildings within and adjacent to the tract,
- c.) citation of any existing legal rights-of-way or easements affecting the property,
- d.) soil loss calculations as estimated by the Universal Soil Loss Equation (Section 10.6.1)
- e.) a plan of the site at a minimum scale of 1" = 100', showing:
 - 1) address and telephone number of the owner, developer, and permittee,
 - 2) approximate location and width of proposed streets,
 - 3) approximate location and dimension of all proposed or existing lots,
 - 4) approximate location and dimension of all parcels of land which will be dedicated to open space, public use, or will remain undisturbed,
 - 5) existing and proposed topography at a maximum contour interval of five (5) feet,
 - 6) an approximate timing schedule indicating the starting and completion dates of the development,
 - 7) a timing schedule for the sequence of grading and the application of erosion and sediment control measures,
 - 8) acreage of the proposed project,
 - 9) identification of unusual material or soils in land areas to be disturbed and engineering recommendations for correcting any problems,
 - 10) identification of suitable fill materials, including the type and source of outside fill materials,
 - 11) specification of measures to control runoff, erosion and sedimentation during construction, noting the areas where controls are required and the type of controls employed,
 - 12) measures to protect neighboring built-up areas and city property during construction, and
 - 13) provisions to stabilize soils and slopes after construction is complete, including when and where stabilization measures will be employed.

10.1 GENERAL - Continued

4. Complete Grading & Drainage Plan Requirements - Continued

The Complete Plan must include the seal and signature of a registered engineer. If all boundary street and drainage improvements are in place, the seal and signature of a registered architect or landscape architect is acceptable.

A Grading and Drainage Plan Checklist has been prepared and is included in Appendix A at the end of this section.

5. Other Permit Requirements

Application to Develop in a Flood Hazard Area

Proposed development within Special Flood Hazard Areas of the City requires the developer or their agent to obtain and complete an Application and Permit Form to Develop in a Flood Hazard Area. Work within the 100-year floodplain requires the applicant to complete FEMA Form TOD-1: Certification/Application Forms For Letters of Map Amendment/Revision Based On Fill. Work within the regulatory floodway, including changes in base flood elevations, fill, channelization and bridge/culvert replacement projects require the applicant to prepare and submit applicable portions of FEMA Form RSD-1: Revisions To National Flood Insurance Maps. Additional information is available from the Civil Engineering Division of the Little Rock Public Works Department at (501) 371-4852.

Section 10 of the Rivers and Harbors Act of 1899

This Act prohibits the obstruction or alteration of navigable waters of the United States without a permit. Section 10 Permits are issued by the United States Army Corps of Engineers Permits Branch, who should be contacted at (501) 324-5295 for additional information.

Clean Water Act Section 404 Permits

Section 301 of this Act prohibits the discharge of dredged or fill material into waters of the United States without a permit. Section 404 Permits are issued by the United States Army Corps of Engineers. Contact the United States Army Corps of Engineers Permits Branch at (501) 324-5295 for more information.

10.1 GENERAL - Continued

5. Other Permit Requirements - Continued

Arkansas Solid Waste Management Code of 1984

The Arkansas Department of Pollution Control and Ecology authorizes all legitimate fill operations. An Application for Request for Fill Area is required to be completed and approved for development consisting of fill for the purpose of surface leveling. Contact the Solid Waste Division of the Arkansas Department of Pollution Control and Ecology at (501) 570-2858 for more information.

Arkansas State Water and Air Pollution Control Act

The Arkansas Department of Pollution Control and Ecology authorizes the discharge of storm water associated with industrial activity from construction sites - those areas or common plans of development or sale that will result in the disturbance of five or more acres total land area. The Department has issued General Permit ARR10A000 for construction activities. A Notice of Intent is required at least 48 hours prior to commencing land disturbance activities. Contact the NPDES Branch of the Arkansas Department of Pollution Control and Ecology at (501) 562-7444 for more information.

Hauling Permit

The Traffic Engineering Division of the Little Rock Public Works Department issues permits for hauling over City streets. Proposed development where fill materials will be transported to or from the development site requires an Application for Hauling Permit to be completed and submitted by the applicant. For more information, contact the Traffic Engineering Division at (501) 371-4858.

Burning Permit

Site clearing often generates timber debris which is burned on site. Burning requires approval from the City Fire Marshall on a permit form furnished by the Fire Department. Contact the Fire Department at (501) 371-4796 for more information, and to obtain permit forms.

Burning of demolition and construction debris is regulated by the Arkansas Department of Pollution Control and Ecology Air Division. Contact the Air Division at (501) 570-2161 for more information.

10.2 STABILIZATION PRACTICES

1. Chemical Stabilization

Chemical stabilization practices involve spraying soil surfaces with various man-made materials to hold the soil in place temporarily. This control is an alternative where temporary seeding is not practical because of the season or climate. Chemical stabilization can provide immediate and effective erosion control anywhere on a construction site.

2. Filter Strips

Filter strips are areas of the site left undisturbed by clearing and construction activities. They are similar to buffer zones, slowing runoff velocity to allow sediment to settle out. However, filter strips serve the additional purpose of allowing runoff to infiltrate into the ground. Filter strips are an effective control applicable to sites where adequate space exists to leave undisturbed areas. Filter strips should be aligned perpendicular to the line of flow, and can be used along with diversion ditches or berms to direct flow onto the vegetated surface area.

See Appendix C for additional information and an illustration.

3. Permanent Seeding and Planting

Permanent seeding and planting (landscaping) to establish vegetation on the site and revegetate disturbed areas reduces erosion by stabilizing soils, filtering sediment, and increasing absorption of runoff by the soil. It also creates habitat and improves the aesthetics of the site. Grasses are the most common type of cover used for revegetation because they grow quickly, providing erosion protection within days. Other soil stabilization practices such as straw bales or mulch may be used during non-growing seasons to prevent erosion. Permanent seeding and planting is appropriate for areas of the site where long-lived plant cover is desired, and is particularly effective in preventing erosion from steep slopes, stream banks, vegetated swales, filter strips and buffer zones.

10.2 STABILIZATION PRACTICES - Continued

4. Preservation of Natural Vegetation

Preserving existing vegetation is the most effective way to prevent erosion. Vegetative cover can be grass, shrubs or trees. Preservation of natural vegetation minimizes erosion potential and protects water quality by filtering and absorbing runoff from a construction site. Newly planted shrubs and trees establish root systems more slowly, so preserving existing shrubs and trees is a more effective practice. Preserving vegetation is also an aesthetic consideration. While this erosion control is applicable to all types of construction sites, it is particularly useful in floodplains, wetlands, along stream banks and steep slopes, and in areas where other erosion controls would be difficult to establish, install or maintain.

5. Sod Stabilization

Sod stabilization provides immediate cover for disturbed soils. It is effective in allowing for runoff infiltration, and once it is established it provides filtering of runoff passing over the sodded area. In this regard, sod stabilization can be used to create buffer zones and filter strips, and is effective for stabilizing slopes, stream banks, swales, outlets, and dikes.

6. Stream Bank Stabilization

Stream bank stabilization is necessary where vegetative practices (seeding, sodding, mulching, etc.) are not practical and where increased flow volume or velocity resulting from construction make stream bank erosion likely. Stream bank stabilization can be accomplished using riprap, gabions, reinforced concrete, grid pavers and asphalt. Riprap consists of large angular stones placed along the stream bank or lake edge. Gabions are rock-filled wire cages used to establish or stabilize a stream bank. Reinforced concrete retaining walls and bulkheads create stream channels which do not erode. Grid pavers are either precast or poured-in-place concrete units that stabilize the stream bank and provide an open space for vegetation to be established. Asphalt paving can also be placed along a stream bank to prevent erosion.

See Appendix C for additional information and an illustration.

10.2 STABILIZATION PRACTICES - Continued

7. Subsurface Drains

A subsurface drain is a perforated pipe or conduit placed beneath the surface of the ground at a designed depth and grade, to lower the water table in an area. A high water table can saturate surface soils and prevent vegetation from being established. On slopes, a high water table can result in slope failure.

8. Temporary Seeding

Temporary seeding means planting a short-term vegetative cover on disturbed site areas which will remain unprotected for long periods, and where permanent plant growth is not necessary. Fast growing annual grasses are capable of stabilizing the soil to prevent erosion from storm runoff and wind. They also reduce dust and mud generation at the construction site. Temporary seeding is appropriate for all sites where disturbed areas will remain unprotected for long periods, but where permanent vegetative cover is not necessary or beneficial.

10.3 EROSION CONTROL METHODS

1. Buffer Zone

Buffer zones are vegetated strips of land which control erosion by reducing the speed of runoff. Buffer zones can be areas left undisturbed during clearing and construction (filter strips), or they can be newly planted in areas that were previously disturbed by clearing and site activity.

2. Diversion Dike

A diversion dike is an earthen ridge used to protect work areas from up-slope runoff and to divert sediment-laden water to sediment traps or stable outlets. Diversion dikes are used above slopes to prevent runoff over the slope. Diversion dikes can be placed across disturbed slopes as slope breaks to reduce slope length, and below slopes to divert runoff to sediment traps or stabilized outlets. Diversion dikes are also effective along the perimeter of the construction site to prevent sediment from running on or off of the site.

See Appendix C for additional information and an illustration.

3. Drainage Swale

A drainage swale is a channel lined with vegetation, riprap, asphalt, concrete or some other material and used to convey runoff without causing erosion. Drainage swales intercept and divert runoff to stabilized outlets or to sediment traps or detention ponds. Drainage swales are often permanent drainage controls which, if established early in the development process, can be effective in preventing erosion from the construction site.

See Appendix C for additional information and an illustration.

10.3 EROSION CONTROL METHODS - Continued

4. Geotextiles

Geotextiles are porous woven fabrics which include filter fabrics of synthetic material, and also biodegradable materials such as mulch matting and netting. In erosion control, geotextiles are used as matting to stabilize soils in channels and swales and along slopes where seeding is being established. Mulch mattings are more stable than simple mulch, and are applied to disturbed areas in sheets. Netting can be used alone to control erosion while temporary seeding is being established, or can be used to hold mulching or mulch matting in place. Mulch binders are also used to hold mulching in place. Geotextiles are also used as separators between riprap and soil, for instance, to prevent soil erosion and maintain the riprap base.

5. Gradient Terraces

Gradient terraces are earth embankments or ridge-and-channels constructed at regular intervals across the face of a slope. Gradient terraces are used to reduce the length of slope on long or steep slopes where erosion is or may be a problem. They should divert runoff to controlled outlets, and should not be used in rocky or sandy soils.

See Appendix C for additional information and an illustration.

6. Interceptor Dikes and Swales

Interceptor dikes (compacted soil ridges, straw bales) and swales (excavated depressions) are used to intercept runoff from disturbed areas, reduce the speed of flow, and divert the flow to a sediment trap or stabilized outlet. Interceptor dikes generally have a parabolic or trapezoidal channel cross-section, and can be either temporary or permanent erosion controls.

See Appendix C for additional information and an illustration.

10.3 EROSION CONTROL METHODS - Continued

7. Mulching

Mulching is temporary erosion control which uses various materials such as grass, hay, straw, wood chips or gravel to cover disturbed areas. Mulch holds soil in place and reduces erosion by absorbing the impact of rain drops. Mulch can also reduce the speed of runoff crossing the disturbed area. Mulch can be used on all site areas where temporary seeding is desirable but seasonal or climatic conditions are not favorable to seed germination. Mulching is also used in conjunction with temporary and permanent seeding to establish cover on unprotected surfaces.

8. Outlet Protection

Outlet protection reduces the speed of concentrated storm water flows. Stone, riprap, concrete aprons, paved sections and settling ponds below outlets prevent scouring and erosion around the outlet. Outlet protection should be applied at locations of all pipe, dike, swale and channel outlets. Outlet protection should be installed early in the development process, and can be added later as necessary to prevent erosion.

See Appendix C for additional information and an illustration.

9. Pipe Slope Drains

Pipe slope drains reduce the potential for erosion by discharging runoff to stabilized areas. Pipe slope drains can be constructed of flexible or rigid pipe, and can be temporary or permanent erosion controls. Pipe slope drains are used to convey runoff from the top of a slope to the bottom without causing erosion. They are useful in protecting new slopes, and where slopes are already damaged by erosion, or where slope failure is highly possible.

See Appendix C for additional information and an illustration.

10.3 EROSION CONTROL METHODS - Continued

10. Surface Roughening

Surface roughening is a temporary erosion control practice where horizontal grooves, depressions or steps run parallel to the contours of the site surface. Surface roughening reduces runoff by reducing the speed of runoff, allowing for infiltration, and trapping sediment. It also helps in establishing vegetative cover, and is appropriate for all slopes. Roughening should be accomplished as soon as possible after site clearing, and can be used in conjunction with other controls, such as seeding and mulching, to establish temporary or permanent cover.

10.4 SILTATION AND SEDIMENT CONTROL

1. Check Dams

Check dams are small temporary or permanent dams constructed across drainage ditches, swales or channels to lower the speed of concentrated flows. Reduced velocity reduces erosion and gullying and allows sediment to settle out. Check dams should be placed in steeply sloped swales and swales where adequate vegetation can not be established. Check dams can be constructed of logs, stone or pea gravel filled sandbags.

See Appendix C for additional information and an illustration.

2. Gravel or Stone Filter Berm

A gravel or stone filter berm is a temporary ridge of loose gravel, crushed rock or stone which diverts flow from exposed traffic areas, slows the speed of flow and filters it. Gravel or stone filter berms are useful on site perimeter areas where vehicular traffic must be accommodated. Diversion dikes or earthen berms can effect the same results as gravel or stone filter berms within the construction site and on gentle slopes.

See Appendix C for additional information and an illustration.

3. Silt Fence

A silt fence, or "filter fabric fence" is a temporary measure for sedimentation control. A properly installed silt fence is generally set on fence posts, with the lower end placed in a vertical trench and backfilled. Silt fence is used in small drainage areas to trap sediment, and is effective in areas of overland flow, and minor swales and drainageways. Silt fences can be placed along a line of uniform elevation at the bottom of a slope, across the flow line. Silt fence can also be used along the outer boundary of the construction site.

See Appendix C for additional information and an illustration.

10.4 SILTATION AND SEDIMENT CONTROL - Continued

4. Sediment Trap

A sediment trap is an excavated pond or an earthen embankment placed across a low area or drainage swale. An outlet or spillway is constructed using stone or aggregate to slow the release of runoff. The sediment trap is a temporary control designed to retain runoff long enough to allow most of the sediment to settle out. Sediment traps are used in conjunction with other controls, such as diversion dikes and berms. Sediment traps should be designed large enough to trap and hold sediment until the trap is cleaned out. Sediment traps require periodic inspection and cleaning, particularly after major storm events.

5. Storm Drain Inlet Protection

Storm drain inlet protection is a filtering control placed around any inlet or drain to trap sediment. Preventing sediment from entering the storm drain system helps prevent siltation of inlets, the storm drainage system and receiving streams and ponds. Storm drain inlet protection is appropriate for small drainage areas where storm drain inlets already exist, or where storm drains will be established prior to final site stabilization. Straw bales are not recommended for this purpose, and while silt or filter fences are effective, they are not practical where paved inlets prevent filter fabric staking. Block and gravel, or gravel and wire mesh filters are recommended where filter fabric can not be placed, or where flow velocity is higher. Sod inlet filters are generally used where flow sedimentation is low.

See Appendix C for additional information and an illustration.

10.4 SILTATION AND SEDIMENT CONTROL - Continued

6. Temporary Sediment Basin

A temporary sediment basin is a settling pond with a controlled outlet which is used to collect and store sediment from the construction site. Temporary sediment basins are constructed similar to sediment traps, either by excavation of the pond or by placing a berm across a low area or drainage swale. Temporary sediment basins serve larger areas than sediment traps, and should be constructed prior to construction activity. They may be either wet or dry ponds, but they should never be built on an embankment of an existing stream. Temporary sediment basins are practical on large sites where topography and other site conditions are favorable, and they may require fencing for safety or to prevent vandalism.

7. Temporary Storm Drain Diversion

A temporary storm drain diversion is a structure which redirects an existing storm drainage system to discharge into a sediment trap or detention basin. Temporary storm drain diversions should intercept flow before it reaches a permanent storm water outfall, and should remain in place as long as disturbed soils remain unstabilized. If site considerations make diversion to a sediment trapping device impractical, then a sediment trap can be constructed below the permanent storm drain outfall.

The most popular temporary storm drain diversion is a straw bale barrier. See Appendix C for additional information and an illustration.

8. Temporary Stream Crossing

A temporary stream crossing is a short-term bridge or culvert which is placed to allow heavy equipment and construction vehicles to cross the stream bed without causing damage to stream banks. Temporary stream crossings should only be used when it is necessary to cross a stream during construction and a permanent crossing has not been completed.

10.5 OTHER EROSION AND SEDIMENT CONTROL METHODS

1. Dust Control

Erosion from wind results whenever surface soils are loose and dry, vegetative cover is sparse or absent, and wind is sufficiently strong. Wind erodes soils and transports sediment away from the construction site, where it may be deposited on adjacent lands and eventually washed into receiving streams. Dust controls which prevent wind erosion include chemical stabilization, mulching, vegetative cover, and sprinkling the construction site with water.

2. Hazardous Products

Many materials found at construction sites contain substances which are hazardous to personnel and the environment. Products which should be considered hazardous include paints, acids for cleaning masonry surfaces, solvents, chemical additives and concrete curing compounds. Read and follow label directions regarding use, storage and disposal of these materials.

3. Off-Site Vehicle Tracking of Sediment

Off-site vehicle tracking of sediments is a common problem at construction sites. Construction road stabilization and stabilized construction entrances are two means of addressing sedimentation problems resulting from vehicle tracking. Paved streets and roads adjacent to the construction site should be swept and kept free of sediment regularly.

Construction road stabilization provides a means for construction equipment and vehicles to move around the site without causing significant erosion. A stabilized construction road is designed to be well drained so that water does not puddle or flood the road during rain events, and will typically have a swale to collect and channel runoff to sediment basins. Stabilized construction roads should have a layer of gravel or crushed stone which will cover and protect the road base from erosion. This gravel or crushed stone layer should be inspected and maintained regularly.

A stabilized construction entrance is a portion of the construction road which is constructed with geotextile and large stone. The primary purpose of a stabilized construction entrance is to reduce off-site tracking by vehicles leaving the construction site. This is accomplished by the action of the stone, which will shake and pull soil particles from the wheels of the vehicle. The stone layer also prevents rutting and erosion of the construction entrance.

See Appendix C for additional information and an illustration.

10.5 OTHER EROSION AND SEDIMENT CONTROL METHODS - Continued

4. Waste Disposal

Construction site wastes are a potential source of stormwater pollution and should be carefully managed. These materials include trees and shrubs, packaging materials, surplus and refuse building materials, paints and paint thinners, and hazardous waste materials. Proper disposal of construction site waste includes selecting a designated waste disposal area on-site, providing adequate containers with lids and covers to prevent contact with rainfall, providing regular collection and removal of construction wastes, and disposing of wastes at authorized disposal facilities.

10.6 DESIGN OF EROSION AND SEDIMENT CONTROLS

1. Soil Loss Calculations

Universal Soil Loss Equation

The Universal Soil Loss Equation adopted by the City of Little Rock is:

$$A = R K L S C P \quad \text{where;}$$

A = soil loss in tons per acre per year,
R = rainfall and runoff factor,
K = soil erodibility factor,
L = slope length factor,
S = slope-steepness factor,
C = cover and management factor, and,
P = practice factor.

The rainfall and runoff factor (R) is 300 for Pulaski County, Arkansas. Therefore, the Universal Soil Loss Equation takes the following form:

$$A = 300 K L S C P.$$

Soil erodibility factors K are presented in Table 10-1 (Appendix B) for all soils identified by soil classification within Pulaski County, Arkansas. Soil association maps are found in the Soil Survey of Pulaski County, Arkansas, published by the USDA Soil Conservation Service. (See References, Appendix D.)

10.6 DESIGN OF EROSION AND SEDIMENT CONTROLS - Continued

1. Soil Loss Calculations - Continued

The slope length factor (L) and the slope-steepness factor (S) can be combined and identified as the topographic factor (LS). Values for LS are found in Table 10-2 (Appendix B), which identifies the topographic factor for specific combinations of slope length and steepness.

The cover and management factor (C) represents the ratio of soil loss from land managed through mulching, vegetation and revegetation to soil loss from disturbed and unprotected lands. Where site preparation removes all vegetation and also the root zone of plants, the soil is left completely unprotected and the value of C = 1. Cover and management factors for mulching are presented in Table 10-3 (Appendix B). Cover and management factors for vegetation practices are presented in Table 10-4 (Appendix B).

The practice factor (P) represents the ratio of soil loss with a specific management practice to the corresponding loss from unprotected slopes. Where no management practice for erosion control is provided, the value of P = 1. Practice factors for gradient terraces, earth dikes, and interceptor dikes and swales are presented in Table 10-5 (Appendix B). Practice factors for buffer zones, filter strips and natural vegetation are presented in Table 10-6 (Appendix B).

The above information, when incorporated into the Universal Soil Loss Equation, produces the following:

$$A = 300 (K) (LS) (C) (P) \text{ where;}$$

- A = soil loss in tons/acre/year,
- R = 300, a constant
- K = soil erodibility factor (table 10-1),
- LS = slope length factor (table 10-2),
- C = cover & management factor (tables 10-3,4) and,
- P = practice factor (tables 10-5,6).

10.6 DESIGN OF EROSION AND SEDIMENT CONTROLS - Continued

2. Erosion Controls - Example #1

A commercial development site is being proposed in western Little Rock. A typical Site Plan is submitted to the City for review (See Figure #1 on the following page). The site will be cleared prior to building construction, but no schedule for construction is available. The site is not located within the 100-year flood hazard boundary.

Step One

In order to determine whether the site requires a Grading and Drainage Plan, it is necessary to determine: A) total site area; B) disturbed area; C) maximum vertical height of cut and fill slopes, D) the quantity of excavation, and E) vicinity of the site with respect to the 100-year floodplain.

A.) The site consists of a total area of:

$$\text{Total Area} = [325' \times 250'] = 81,250 \text{ ft.}^2$$

$$\text{Total Area} = 81,250 \text{ ft.}^2 \times [1 \text{ acre} / 43,560 \text{ ft.}^2]$$

$$\underline{\text{Total Area} = 1.87 \text{ acres}}$$

B.) The disturbed area of the site is the total area of the site reduced by the width of undisturbed perimeter strips, which are required to be 25 feet wide for simple land clearing operations:

$$\text{Disturbed Area} = 275 \times 200 = 55,000 \text{ S.F.}$$

$$\text{Disturbed Area} = 55,000 \text{ ft.}^2 \times [1 \text{ acre} / 43,560 \text{ ft.}^2]$$

$$\underline{\text{Total Area} = 1.26 \text{ acres}}$$

A Grading and Drainage Plan is required. The disturbed area exceeds one acre in size and is more than twenty-five percent of the total tract.

NOTE: In this example it was not possible to calculate the maximum vertical height of cut and fill slopes (C) or the quantity of excavation (D). This information would have either been requested from the applicant, or the permit would be restricted to site clearing activity only until this information was made available. For the purpose of this example problem, the site is determined not to be within the 100-year floodplain boundary (E).

10.6 DESIGN OF EROSION AND SEDIMENT CONTROLS - Continued

2. Erosion Controls - Example #1 - Figure #1

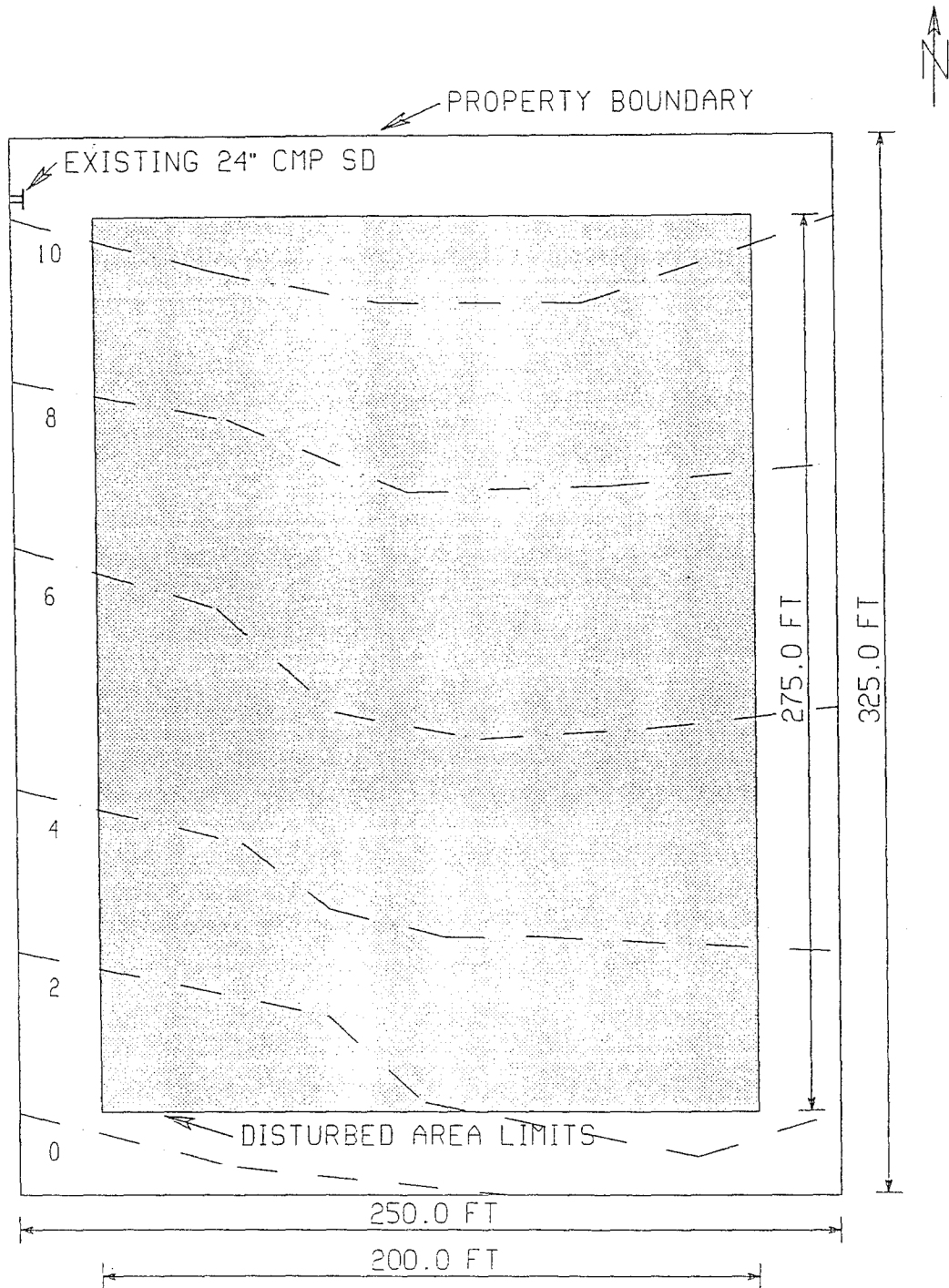

TOTAL AREA = 1.87 ACRES
DISTURBED AREA = 1.26 ACRES

1"=50'

10.6 DESIGN OF EROSION AND SEDIMENT CONTROLS - Continued

2. Erosion Controls - Example #1 - Continued

Step Two

In Step One it was determined that a Grading and Drainage Plan is required. Now it is necessary to determine what erosion and sedimentation controls are required to control construction site runoff.

In order to determine what controls are required: A) an initial soil loss calculation is performed with no controls in place; B) where soil loss potential exceeds 5 tons/acre/year, stabilization practices, erosion controls and sedimentation controls are identified and placed on the Plan; and, C) a soil loss calculation is performed to determine the effects of controls on soil loss potential.

A.) Initial soil loss calculation:

1. $A = 300 (K) (LS) (C) (P)$ where;

- A = soil loss in tons per acre per year,
- R = 300, a constant
- K = soil erodibility factor from (Table 10-1),
- LS = slope length factor from (Table 10-2),
- C = cover and management factor
from (Tables 10-3,4), and,
- P = practice factor from (Tables 10-5,6).

2. Western Little Rock and Pulaski County soils are identified from the Soil Survey of Pulaski County as within the Mountainburg soils association, CMC.

From the Site Map topography, a vertical difference of approximately ten feet is observed over the 275 foot length of the disturbed area. This is equal to a slope of 10/275, or a four percent slope. Table 10-1 (Appendix B) identifies Mountainburg (CMC) with a slope range of 3-12 percent as having a K factor of 0.17, therefore;

$$K = 0.17$$

10.6 DESIGN OF EROSION AND SEDIMENT CONTROLS - Continued

2. Erosion Controls - Example #1 - Continued

A.) Initial soil loss calculation - continued.

Step Two - continued.

3. Table 10-2 (Appendix B) identifies the LS factor for a four percent slope of 200' as being 0.528, and the LS factor for a four percent slope of 300' as being 0.621. Interpolating between these values provides the LS factor for the site, therefore;

$$LS = 0.528 + [(0.621 - 0.528) * [(275 - 200)/(300 - 200)]]$$

$$LS = 0.528 + [0.093 * (75/100)]$$

$$LS = 0.528 + 0.070$$

$$LS = 0.598$$

4. There is no site cover after clearing is completed, and therefore $C = 1$.
5. No control practices are being implemented, and therefore $P = 1$.
6. Placing the values above into the Soil Loss Calculation produces the following equation:

$$A = 300 (K) (LS) (C) (P)$$

$$A = 300 (0.17) (0.598) (1) (1)$$

$$A = 30.50 \text{ tons/acre/year potential soil loss from this site.}$$

- B.) Identification of stabilization, erosion and sedimentation controls.

Erosion potential exceeds the allowable soil loss for the site, and therefore controls are warranted. The first stabilization practice identified is to mulch and seed immediately after the end of site grading. The effects of these controls are examined below.

10.6 DESIGN OF EROSION AND SEDIMENT CONTROLS - Continued

2. Erosion Controls - Example #1 - Continued.

Step Two - continued.

Table 10-3 (Appendix B) provides cover and management factors for mulching disturbed areas. Loose straw or hay applied at a rate of 2 tons/acre on slopes from one to five percent yields a C factor of 0.12, with a maximum slope length of 400 feet. Mulch at this rate will not impede seed germination, so mulch and seed will be applied simultaneously to the site.

C.) The impact on potential soil loss from mulching is:

$$A = 300 (0.17) (0.598) (C) (P)$$

where $C = 0.12$

therefore;

$$A = 300 (0.17) (0.598) (0.12) (1), \quad \text{or}$$

$$A = \underline{3.66 \text{ tons/acre/year.}}$$

The potential soil loss is now below the allowable soil loss of 5.0 tons/acre/year, and therefore mulch will satisfy Municipal Code requirements during construction.

10.6 DESIGN OF EROSION AND SEDIMENT CONTROLS - Continued

2. Erosion Controls - Example #1 - Continued

Step Two - continued.

- B.) Table 10-4 (Appendix B) provides cover and management factors for vegetation of disturbed areas. Assume that a rapidly growing grass is used to establish permanent vegetative cover, and that a 40 percent ground cover will be established.

The impact on potential soil loss is:

$$A = 300 (0.17) (0.598) (C) (P)$$

where $C = 0.10$

therefore;

$$A = 300 (0.17) (0.598) (0.10) (1), \quad \text{or}$$

$$A = \underline{3.05 \text{ tons/acre/year.}}$$

A Sketch Grading and Drainage Plan is required, because stabilization practices are adequate to address the potential soil loss in Example #1. Where erosion and sedimentation controls are required to control runoff, a Complete Grading and Drainage Plan is required.

The Sketch Plan for this site would include the information contained on Figure #1, as well as the information provided in Steps One & Two above. Based upon the information presented in the example and on Figure #1, a Grading Permit would be issued, subject to several conditions:

- 1) No excavation would be allowed under this permit, because no building plan was included, the estimated volume of cut and fill was not provided and the height of vertical cut and fill slopes were not identified.
- 2) A 25 foot undisturbed perimeter filter strip would be required.
- 3) The contractor would be required to apply mulch as soon as possible after disturbing sections of the site. Areas disturbed by excavation and left idle by construction for periods of two weeks or more should be scheduled for mulch and/or seeding within three weeks of the date that grading is completed. Refer to the Little Rock Site Development guide for information on the selection and application of seed and other landscaping requirements.

10.6 DESIGN OF EROSION AND SEDIMENT CONTROLS - Continued

3. Siltation and Sediment Controls - Example #2

A Building Permit application is submitted for the commercial building site proposed in the previous example. The Site Plan identified as Figure #2 on the following page is submitted, showing proposed parking and the building footprint.

Step One

In order to determine whether the site requires a Grading and Drainage Plan, it is necessary to determine: A) total site area; B) disturbed area; C) maximum vertical height of cut and fill slopes; D) the quantity of excavation, and, E) vicinity to the floodplain.

The total area of the site remains at 1.87 acres. However, the disturbed area has been reduced to 1.00 acres. The maximum vertical cut/fill slope height is identified as four feet. The estimated volume of excavation from Figure #2 is 3,240 cubic yards (surface area multiplied by average depth of fill). The property is not identified as being within the 100-year floodplain boundary.

A Grading Permit is still required, because the disturbed area is approximately one acre and is more than twenty-five percent of the total area, and because the volume of excavation will exceed 3,000 cubic yards.

10.6 DESIGN OF EROSION AND SEDIMENT CONTROLS - Continued

3. Siltation & Sediment Controls Example #2 - Figure #2

TOTAL CUT FILL VOLUME = $[(250 \times 175 \times 2)/27] = 3,240 \text{ C.Y.}$

MAXIMUM VERTICAL CUT/FILL SLOPE = .4'

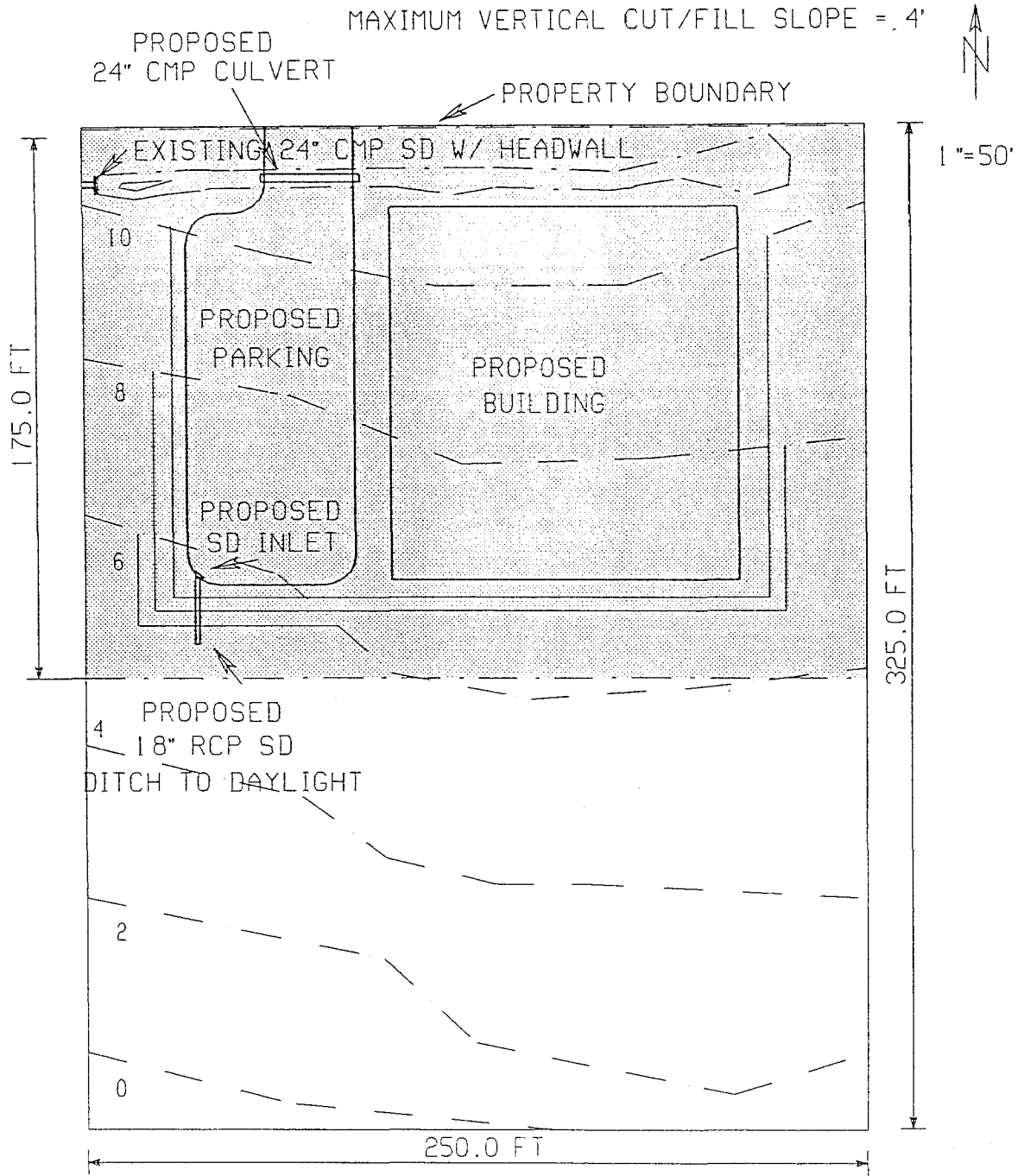

--- EXISTING CONTOUR ---
— PROPOSED CONTOUR —

□ DISTURBED AREA

10.6 DESIGN OF EROSION AND SEDIMENT CONTROLS - Continued

3. Siltation & Sediment Controls Example #2 - Continued

Step Two

In Step One it was determined that a Grading Permit is required. Now it is necessary to determine what erosion and sedimentation controls are required to control construction site runoff.

In order to determine what controls are required: A) an initial soil loss calculation is performed with no controls in place; B) where soil loss potential exceeds 5 tons/acre/year, stabilization practices, erosion controls and sedimentation controls are identified and placed on the Plan; and, C) a soil loss calculation is performed to determine the effects of controls on soil loss potential.

A.) Initial soil loss calculation:

1. $A = 300 (K) (LS) (C) (P)$ where;

A = soil loss in tons per acre per year,
 R = 300, a constant
 K = soil erodibility factor from (Table 10-1),
 LS = slope length factor from (Table 10-2),
 C = cover and management factor
 from (Tables 10-3,4), and,
 P = practice factor from (Tables 10-5,6).

2. Site soil was previously identified from the Soil Survey of Pulaski County as within the Mountainburg soils association, CMC.

10.6 DESIGN OF EROSION AND SEDIMENT CONTROLS - Continued

3. Siltation & Sediment Controls Example #2 - Continued

Step Two - continued

From the Site Map topography, a vertical difference of approximately five feet is observed over the 175 foot length of the major disturbed area. This is equal to a slope of 5/175, or a three percent slope. Table 10-1 (Appendix B) identifies Mountainburg (CMC) with a slope range of 3-12 percent as having a K factor of 0.17, therefore;

$$K = 0.17$$

3. Table 10-2 (Appendix B) identifies the LS factor for a three percent slope of 150' as being 0.325, and the LS factor for a three percent slope of 200' as being 0.354. Interpolating between these values provides the LS factor for the site, which has a slope length of 175 feet. Therefore;

$$LS = 0.325 + [(0.354 - 0.325) * [(175 - 100)/(200 - 100)]]$$

$$LS = 0.325 + [0.029 * (25/50)]$$

$$LS = 0.325 + 0.015$$

$$LS = 0.340$$

4. Since there is no remaining site cover after clearing is completed, C = 1
5. Since there are no control practices being implemented, P = 1.

Therefore:

$$A = 300 (K) (LS) (C) (P)$$

$$A = 300 (0.17) (0.340) (1) (1)$$

$$A = 17.34 \text{ tons/acre/year potential soil loss from this site.}$$

10.6 DESIGN OF EROSION AND SEDIMENT CONTROLS - Continued

3. Siltation & Sediment Controls Example #2 - Continued

Step Two - continued

B.) Erosion potential exceeds the allowable soil loss for the site, and so controls are warranted. The first stabilization practice identified is to mulch and seed immediately after the end of site grading. The effects of these controls are examined below:

1. Table 10-3 (Appendix B) provides cover and management factors for mulching disturbed areas. Loose straw or hay applied at a rate of 1 ton/acre on slopes from one to five percent yields a C factor of 0.4, with a maximum slope length of 200 feet.

The impact on potential soil loss is:

$$A = 300 (0.17) (0.340) (C) (P)$$

where C = 0.40

therefore;

$$A = 300 (0.17) (0.340) (0.40) (1), \quad \text{or}$$

$$A = \underline{6.94 \text{ tons/acre/year.}}$$

The potential soil loss continues to exceed the allowable soil loss of 5.0 tons/acre/year, and therefore mulch alone will not satisfy Municipal Code requirements.

2. Table 10-4 (Appendix B) provides cover and management factors for vegetation of disturbed areas. Assuming that a rapidly growing grass is used to establish permanent vegetative cover, and that a 40 percent ground cover will be established, the impact on potential soil loss is:

$$A = 300 (0.17) (0.340) (C) (P)$$

where C = 0.10

therefore;

$$A = 300 (0.17) (0.340) (0.10) (1), \quad \text{or}$$

$$A = \underline{1.73 \text{ tons/acre/year.}}$$

10.6 DESIGN OF EROSION AND SEDIMENT CONTROLS - Continued

3. Siltation & Sediment Controls Example #2 - Continued

Step Two - continued

As seen in the previous calculations, once a vegetative cover is established on the site, the potential soil loss will be reduced to 1.73 tons/acre/year. This is below the maximum allowable soil loss. However, during construction and immediately following site grading, erosion potential from the site and steep slopes will exceed 5 tons/acre/year, even with the application of mulch. Additional controls are needed during construction.

3. Table 10-6 (Appendix B) provides Practice Factors (P) for buffer zones, filter strips and natural vegetation. The disturbed area of the site flows onto a portion of the site which will be left undisturbed. A land slope of three percent (not to exceed 300 feet in length) with a buffer zone of fifty feet in width will yield a P factor of 0.50.

The impact on potential soil loss from mulch combined with a fifty-foot wide buffer zone is:

$$A = 300 (0.17) (0.340) (C) (P)$$

where $C = 0.40$, $P = 0.50$

therefore;

$$A = 300 (0.17) (0.340) (0.40) (0.50)$$

$$A = 3.47 \text{ tons/acre/year.}$$

The combination of mulch with buffer zones will satisfy Grading Permit requirements during construction, since the potential soil loss of 3.47 tons/acre/year is within the allowable soil loss of 5 tons/acre/year.

10.6 DESIGN OF EROSION AND SEDIMENT CONTROLS - Continued

3. Siltation & Sediment Controls Example #2 - Continued

Step Three

In Step One it was determined that a Grading Permit would be required for the proposed development site, based upon both the disturbed area and the estimated volume of cut and fill material. In Step Two, controls were identified through a repetitive process of soil loss calculations and control identification until the appropriate controls were determined.

Step Three involves placing the controls on-site to achieve maximum effect in reducing erosion and sedimentation from the site.

- A.) Figure #2 identifies the disturbed areas of the site and other critical features where controls are necessary. These features include; an existing storm drain, a proposed storm drain outfall, and cut/fill slopes. These features will require controls in addition to the mulching, seeding and buffer zone identified in Step Two. Each of these features is addressed separately below.
- B.) Shaded areas require mulch and seeding. Mulch is to be applied at the rate of one ton per acre. Seed application is required to establish a vegetative cover over disturbed areas. Mulch and seed are generally required to be placed within two weeks of the completion of grading of any section of the site, where such disturbed sections of the site will remain idle for more than three weeks.
- C.) Storm drain inlet protection is required to protect the existing storm drain inlet from sedimentation.
- D.) Outlet protection is required at the outfall of the proposed storm drain, to prevent erosion of natural cover. Since no discharge velocity is provided, the outlet protection is considered a permanent erosion control and will remain in place after the completion of construction.

10.6 DESIGN OF EROSION AND SEDIMENT CONTROLS - Continued

3. Siltation & Sediment Controls Example #2 - Continued

Step Three - Continued

- E.) A stormwater diversion, in this example a straw bale barrier, is placed south of the disturbed area to intercept construction runoff and direct it toward the gravel/stone filter berm, then on to the undisturbed buffer zone.
- F.) Both the gravel/stone filter berm and the buffer zone are designed to direct sheet flow across the undisturbed portion of the site. This reduces runoff velocity, traps sediment and increases infiltration of runoff to the existing soil and vegetation.

Figure #3 on the following page shows the placement of the above controls with respect to critical site features.

10.6 DESIGN OF EROSION AND SEDIMENT CONTROLS - Continued

3. Siltation & Sediment Controls Example #2 - Figure #3

CONSTRUCT STORM DRAIN INLET PROTECTION AS REQUIRED TO PREVENT SEDIMENTATION OF EXISTING STORM DRAIN SYSTEM.

PLACE RIPRAP AND SUITABLE OUTLET PROTECTION @ PROPOSED 18" RCP SD TO PREVENT EROSION.

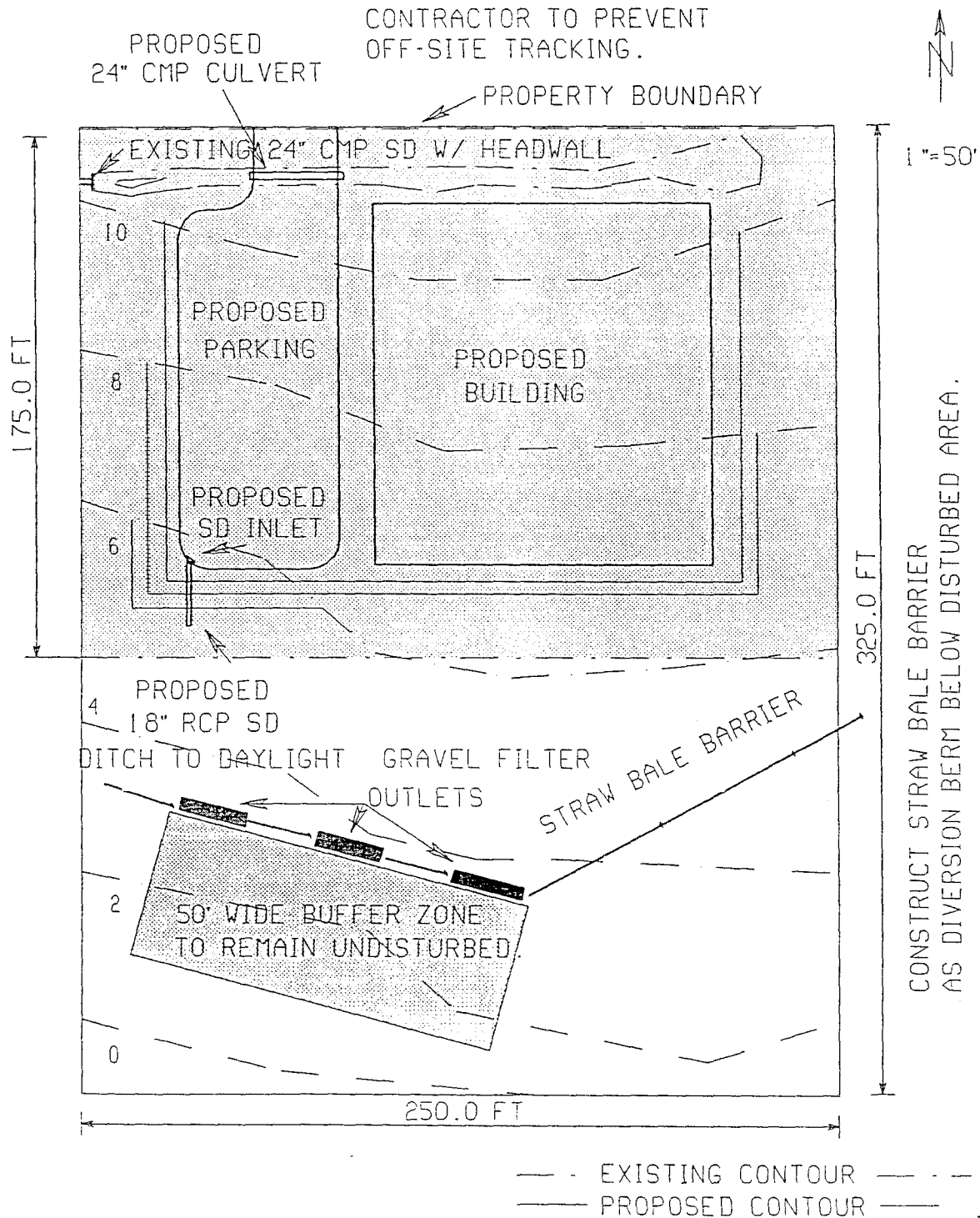

R: 3/94

MULCH EXPOSED AREAS LEFT IDLE FOR THREE WEEKS OR MORE WITH LOOSE STRAW @ 1 TON/ACRE MINIMUM

10.7 APPENDICES

A - GRADING AND DRAINAGE PLAN CHECKLIST

B - SOIL LOSS CALCULATION TABLES

C - EROSION AND SEDIMENTATION CONTROLS

D - REFERENCES

APPENDIX A - GRADING AND DRAINAGE PLAN CHECKLIST

APPLICATIONS TO THE PLANNING COMMISSION FOR PLANNED UNIT DEVELOPMENTS, CONDITIONAL USE PERMITS, SITE PLAN REVIEW, SUBDIVISIONS OR MULTIPLE BUILDING SITE APPROVALS:

A SKETCH GRADING AND DRAINAGE PLAN IS REQUIRED IF;

- 1) CUT OR FILL ACTIVITY GREATER THAN FIFTEEN (15) VERTICAL FEET IS INVOLVED, OR
- 2) CUT OR FILL VOLUME EQUAL TO OR GREATER THAN 3,000 CUBIC YARDS IS INVOLVED, OR
- 3) CLEARING EXCEEDS ONE (1) ACRE IN AREA, OR
- 4) CLEARING WILL OCCUR ON ANY LAND WITHIN THE 100-YEAR FLOODPLAIN BOUNDARY.

APPLICATIONS FOR AGRICULTURAL USES OR FORESTRY ACTIVITIES ON LAND OWNED BY FOREST-RELATED INDUSTRIES:

A SKETCH GRADING AND DRAINAGE PLAN IS REQUIRED IF;

- 1) CLEARING EXCEEDS ONE (1) ACRE IN AREA, OR
- 2) CLEARING WILL OCCUR ON ANY LAND WITHIN THE 100-YEAR FLOODPLAIN BOUNDARY.

APPLICATIONS FOR BUILDING PERMITS:

A COMPLETE GRADING AND DRAINAGE PLAN IS REQUIRED IF;

- 1) CUT OR FILL ACTIVITY GREATER THAN FIFTEEN (15) VERTICAL FEET IS INVOLVED, OR
- 2) CUT OR FILL VOLUME EQUAL TO OR GREATER THAN 3,000 CUBIC YARDS IS INVOLVED, OR
- 3) CLEARING EXCEEDS ONE (1) ACRE IN AREA, OR
- 4) CLEARING WILL OCCUR ON ANY LAND WITHIN THE 100-YEAR FLOODPLAIN BOUNDARY.

SITE PLANS WHICH DO NOT MEET THE CRITERIA FOR A GRADING AND DRAINAGE PLAN SET FORTH ABOVE MUST INCLUDE CERTIFICATION FROM THE ARCHITECT AND/OR ENGINEER THAT THE CRITERIA ARE NOT APPLICABLE TO THE PROPOSED DEVELOPMENT. FAILURE TO PROVIDE CERTIFICATION WILL RESULT IN THE PLAN BEING REJECTED BY THE CITY ENGINEER.

APPENDIX A - GRADING AND DRAINAGE PLAN CHECKLIST - Continued

SKETCH GRADING AND DRAINAGE PLAN REQUIREMENTS

A SKETCH GRADING AND DRAINAGE PLAN MUST IDENTIFY AND/OR INCLUDE THE FOLLOWING INFORMATION:

- 1) ACREAGE OF THE PROPOSED PROJECT,
- 2) LAND AREA TO BE DISTURBED,
- 3) STAGES OF GRADING - SECTIONS TO BE DISTURBED AND SEQUENCE,
- 4) EXTENT OF CUT AND FILL - INDICATE HEIGHT AND SLOPE,
- 5) PROVISIONS FOR COLLECTING AND DISCHARGING SURFACE WATER, &
- 6) EROSION AND SEDIMENT CONTROL MEASURES TO BE USED.

THE SKETCH GRADING AND DRAINAGE PLAN REQUIRES THE SIGNATURE OF A REGISTERED ENGINEER, ARCHITECT OR LANDSCAPE ARCHITECT WHICH CERTIFIES THAT THE PLAN COMPLIES WITH MUNICIPAL CODE REQUIREMENTS.

PLANS FOR AREAS OF LESS THAN FIVE (5) ACRES WHERE VERTICAL CUT AND FILL HEIGHT DO NOT EXCEED FIFTEEN (15) FEET MAY BE PREPARED BY THE CONTRACTOR OR THE PROPERTY OWNER.

PLANS FOR AREAS WHERE ONLY TREE CLEARING IS INVOLVED MAY BE PREPARED BY THE CONTRACTOR OR THE PROPERTY OWNER.

SKETCH PLANS WHICH DO NOT CONTAIN THE MINIMUM INFORMATION SET FORTH ABOVE WILL BE REJECTED BY THE CITY ENGINEER.

APPENDIX A - GRADING AND DRAINAGE PLAN CHECKLIST - Continued

COMPLETE GRADING AND DRAINAGE PLAN REQUIREMENTS

A COMPLETE GRADING AND DRAINAGE PLAN MUST IDENTIFY AND/OR INCLUDE THE FOLLOWING INFORMATION:

- 1) ACREAGE OF THE PROPOSED PROJECT,
- 2) LAND AREA TO BE DISTURBED,
- 3) STAGES OF GRADING - SECTIONS TO BE DISTURBED AND SEQUENCE,
- 4) EXTENT OF CUT AND FILL - INDICATE HEIGHT AND SLOPE,
- 5) PROVISIONS FOR COLLECTING AND DISCHARGING SURFACE WATER, &
- 6) EROSION AND SEDIMENT CONTROL MEASURES TO BE USED,
- 7) A VICINITY DRAWING SHOWING PROPERTY LINES, EXISTING AND PLATTED STREETS AND PUBLIC WAYS LOCATED WITHIN OR IMMEDIATELY ADJACENT TO THE SITE,
- 8) LOCATION OF ALL KNOWN SEWERS, WATER MAINS, CULVERTS AND UNDERGROUND UTILITIES WITHIN OR IMMEDIATELY ADJACENT TO THE SITE;
- 9) LOCATION OF EXISTING PERMANENT BUILDINGS WITHIN OR IMMEDIATELY ADJACENT TO THE SITE;
- 10) CITATION OF ANY EXISTING LEGAL RIGHTS-OF-WAY OR EASEMENTS AFFECTING THE PROPERTY;
- 11) SOIL LOSS CALCULATIONS AS ESTIMATED BY THE UNIVERSAL SOIL LOSS EQUATION;
- 12) A SITE PLAN AT A MINIMUM SCALE OF ONE (1) INCH EQUALS ONE HUNDRED (100) FEET SHOWING;
 - A) ADDRESS AND TELEPHONE NUMBER OF THE OWNER, DEVELOPER, AND CONTRACTOR,
 - B) APPROXIMATE LOCATION AND WIDTH OF PROPOSED STREETS,
 - C) APPROXIMATE LOCATION AND DIMENSION OF ALL PROPOSED OR EXISTING LOTS,
 - D) APPROXIMATE LOCATION AND DIMENSION OF ALL PARCELS OF LAND PROPOSED TO BE SET ASIDE FOR OPEN SPACE OR PUBLIC USE,
 - E) EXISTING AND PROPOSED TOPOGRAPHY AT A MAXIMUM OF FIVE (5) FOOT CONTOUR INTERVALS,

APPENDIX A - GRADING AND DRAINAGE PLAN CHECKLIST - Continued

COMPLETE GRADING AND DRAINAGE PLAN REQUIREMENTS - Continued

12) SITE PLAN REQUIREMENTS - Continued

- F) AN APPROXIMATE TIMING SCHEDULE FOR DEVELOPMENT, INCLUDING THE START AND COMPLETION DATES FOR DEVELOPMENT AND A TIMING SCHEDULE FOR THE GRADING WHICH INCLUDES THE APPLICATION OF EROSION AND SEDIMENTATION CONTROL MEASURES,
- G) IDENTIFICATION OF UNUSUAL MATERIAL OR SOILS IN LAND AREAS TO BE DISTURBED,
- H) IDENTIFICATION OF SUITABLE FILL MATERIAL (NOTE TYPE AND SOURCE OF OUTSIDE FILL MATERIALS),
- I) SPECIFICATIONS TO CONTROL RUNOFF, EROSION AND SEDIMENTATION DURING CONSTRUCTION,
- J) SPECIFICATION OF MEASURES TO PROTECT NEIGHBORING BUILT-UP AREAS AND THE MUNICIPAL STORM SEWER DURING CONSTRUCTION,
- K) PROVISIONS TO STABILIZE SOILS AND SLOPES AFTER COMPLETION OF IMPROVEMENTS, NOTING WHEN AND WHERE CONTROLS WILL BE PLACED.

THE COMPLETE GRADING AND DRAINAGE PLAN REQUIRES THE SIGNATURE OF A REGISTERED ENGINEER WHICH CERTIFIES THAT THE PLAN COMPLIES WITH MUNICIPAL CODE REQUIREMENTS.

THE SEAL OF A REGISTERED ARCHITECT OR LANDSCAPE ARCHITECT WILL BE ACCEPTED IF ALL REQUIRED BOUNDARY STREET AND DRAINAGE IMPROVEMENTS ARE IN PLACE.

COMPLETE PLANS WHICH DO NOT CONTAIN THE MINIMUM INFORMATION SET FORTH ABOVE WILL BE REJECTED BY THE CITY ENGINEER.

APPENDIX B - SOIL LOSS CALCULATION TABLES

TABLE 10-1 SOIL ERODIBILITY FACTOR - K				
SYMBOL	SOIL NAME	SLOPE RANGE (Percent)	SOIL TEXTURE	K FACTOR
Cr	Crevasse	0 - 2	FS	0.15
Bs	Bruno	0 - 2	SL	0.17
Bu	Bruno	0 - 1	SL	0.17
CMC	Mountainburg	3 - 12	ST-FSL	0.17
CMF	Mountainburg	12 - 40	ST-FSL	0.17
LRE	Mountainburg	12 - 25	ST-FSL	0.17
MoD	Mountainburg	3 - 12	ST-FSL	0.17
SfC	Saffell	3 - 8	GR-FSL	0.20
LRE	Linker	12 - 25	GR-FSL	0.24
LkC	Linker	3 - 8	GR-FSL	0.24
LnC	Linker	3 - 8	GR-FSL	0.24
MuD	Mountainburg	3 - 12	FSL	0.24
MuE	Mountainburg	12 - 40	FSL	0.24
StC	Smithdale	3 - 8	FSL	0.28
StD	Smithdale	8 - 12	FSL	0.28
SuC	Smithdale	3 - 8	FSL	0.28
CMC	Carnasaw	3 - 12	GR-SIL	0.32
CMF	Carnasaw	12 - 40	GR-SIL	0.32
CaC	Carnasaw	3 - 8	GR-SIL	0.32
CaD	Carnasaw	8 - 12	GR-SIL	0.32
CbC	Carnasaw	3 - 8	GR-SIL	0.32
CbD	Carnasaw	8 - 12	GR-SIL	0.32
La	Latanier	0 - 1	SIC	0.32
Me	Moreland	0 - 1	SIC	0.32
No	Norwood	0 - 1	SICL	0.32

(CONTINUED ON NEXT PAGE)

LEGEND: C = Clay	FS = Fine Sand
GR-FSL = Gravelly Fine Sandy Loam	SIC = Silty Clay
GR-SIL = Gravelly Silt Loam	SICL = Silty Clay Loam
ST-FSL = Stony Fine Sandy Loam	SL = Silt Loam

SOURCE: USDA Soil Conservation Service - Pulaski County.

APPENDIX B - SOIL LOSS CALCULATION TABLES - Continued

TABLE 10-1 (CONTINUED)				
SOIL ERODIBILITY FACTOR - K				
SYMBOL	SOIL NAME	SLOPE RANGE (Percent)	SOIL TEXTURE	K FACTOR
Pe	Perry	0 - 1	C	0.32
Pu	Perry	0 - 1	C	0.32
RpB	Perry	0 - 3	C	0.32
SgB	Sallisaw	1 - 3	GR-SIL	0.32
SgC	Sallisaw	3 - 5	GR-SIL	0.32
ShC	Sallisaw	3 - 5	GR-SIL	0.32
TaB	Tiak	1 - 3	FSL	0.32
TuC	Tiak	3 - 8	FSL	0.32
Re	Rexor	0 - 2	SIL	0.37
Rf	Rexor	0 - 2	SIL	0.37
SKC	Sallisaw	2 - 6	SIL	0.37
Am	Amy	0 - 1	SIL	0.43
Ao	Amy	0 - 1	SIL	0.43
ApB	Amy	0 - 1	SIL	0.43
Au	Amy	0 - 1	SIL	0.43
GeB	Guthrie	0 - 2	SIL	0.43
GeB	Leadvale	0 - 3	SIL	0.43
Ko	Keo	0 - 1	SIL	0.43
Ku	Keo	0 - 1	SIL	0.43
LdB	Leadvale	1 - 3	SIL	0.43
LdC	Leadvale	3 - 8	SIL	0.43
LeB	Leadvale	1 - 3	SIL	0.43
LeC	Leadvale	3 - 8	SIL	0.43
RmA	Rilla	0 - 1	SIL	0.43
RmC	Rilla	3 - 5	SIL	0.43
RpB	Rilla	0 - 5	SIL	0.43
RuA	Rilla	0 - 1	SIL	0.43
SKC	Leadvale	2 - 8	SIL	0.43
Wt	Wrightsville	0 - 1	SIL	0.49
Wu	Wrightsville	0 - 1	SIL	0.49
LEGEND: C = Clay				
GR-FSL = Gravelly Fine Sandy Loam			FS = Fine Sand	
GR-SIL = Gravelly Silt Loam			SIC = Silty Clay	
ST-FSL = Stony Fine Sandy Loam			SICL = Silty Clay Loam	
			SL = Silt Loam	

SOURCE: USDA Soil Conservation Service - Pulaski County.

APPENDIX B - SOIL LOSS CALCULATION TABLES - Continued

TABLE 10-2 TOPOGRAPHIC FACTOR (LS) FOR SPECIFIC COMBINATIONS OF SLOPE LENGTH AND STEEPNESS									
PERCENT	SLOPE LENGTH								
	25	50	75	100	150	200	300	400	500
0.2	.060	.069	.075	.080	.086	.092	.099	.105	.110
0.5	.073	.083	.090	.096	.104	.110	.119	.126	.132
0.8	.086	.098	.107	.113	.123	.130	.141	.149	.156
2	.133	.163	.185	.201	.227	.248	.280	.305	.326
3	.190	.233	.264	.287	.325	.354	.400	.437	.466
4	.230	.303	.357	.400	.471	.528	.621	.697	.762
5	.268	.379	.464	.536	.656	.758	.928	1.07	1.20
6	.336	.476	.583	.673	.824	.952	1.17	1.35	1.50
8	.496	.701	.859	.992	1.21	1.41	1.72	1.98	2.22
10	.685	.968	1.19	1.37	1.68	1.94	2.37	2.74	3.06
12	.903	1.28	1.56	1.80	2.21	2.55	3.13	3.61	4.04
14	1.15	1.62	1.99	2.30	2.81	3.25	3.98	4.59	5.13
16	1.42	2.01	2.46	2.84	3.48	4.01	4.92	5.68	6.35
18	1.72	2.43	2.97	3.43	4.21	3.86	5.95	6.87	7.68
20	2.04	2.88	3.53	4.08	5.00	5.77	7.07	8.16	9.12

SOURCE: USDA Agricultural Handbook Number 537, December 1978.

APPENDIX B - SOIL LOSS CALCULATION TABLES - Continued

TABLE 10-3 COVER AND MANAGEMENT FACTOR (C) FOR MULCHING CONSTRUCTION SLOPES				
TYPE OF MULCH	MULCH RATE (tons/acre)	LAND SLOPE (percent)	C FACTOR	LENGTH LIMIT (feet)
None	0	all	1.0	----
Straw or Hay - loose	1.0	1-5	0.4	200
	1.0	6-10	0.4	100
	1.5	1-5	.24	300
	1.5	6-10	.24	150
	2.0	1-5	.12	400
	2.0	6-10	.12	200
	2.0	11-15	.14	150
	2.0	16-20	.22	100
	2.0	21-25	.28	75
	2.0	26-33	.34	50
	2.0	34-50	.40	35
Straw or Hay - tied, anchored or tacked	1.0	1-5	0.2	200
	1.0	6-10	0.2	100
	1.5	1-5	.12	300
	1.5	6-10	.12	150
	2.0	1-5	.06	400
	2.0	6-10	.06	200
	2.0	11-15	.07	150
	2.0	16-20	.11	100
	2.0	21-25	.14	75
	2.0	26-33	.17	50
	2.0	34-50	.20	35
Crushed Stone	135	<16	.05	200
	135	16-20	.05	150
	135	21-33	.05	100
	135	34-50	.05	75
	240	<21	.02	300
	240	21-33	.02	200
	240	34-50	.02	150
Wood Chips	7	<16	.08	75
	7	16-20	.08	50
	12	<16	.05	150
	12	16-20	.05	100
	12	21-33	.05	75
	25	<16	.02	200
	25	16-20	.02	150
	25	21-33	.02	100
	25	34-50	.02	75

SOURCE: USDA Agricultural Handbook Number 537, December 1978.

APPENDIX B - SOIL LOSS CALCULATION TABLES - Continued

TABLE 10-4 COVER AND MANAGEMENT FACTOR (C) FOR VEGETATION PRACTICES								
VEGETATIVE CANOPY			COVER THAT CONTACTS THE SOIL SURFACE					
TYPE AND HEIGHT	PERCENT COVER	TYPE	PERCENT GROUND COVER					
			0	20	40	60	80	95+
No Canopy		G	0.45	0.20	0.10	.042	.013	.003
		W	.45	.24	.15	.091	.043	.011
Tall Weeds or Short Brush (20')	25	G	.36	.17	.09	.038	.013	.003
		W	.36	.20	.13	.083	.041	.011
Short Brush (20')	50	G	.26	.13	.07	.035	.012	.003
		W	.26	.16	.11	.076	.039	.011
	75	G	.17	.10	.06	.032	.011	.003
		W	.17	.12	.09	.068	.038	.011
Brush or Bushes (6 1/2')	25	G	.40	.18	.09	.040	.013	.003
		W	.40	.22	.14	.087	.042	.011
	50	G	.34	.16	.08	.038	.012	.003
		W	.34	.19	.13	.082	.041	.011
	75	G	.28	.14	.08	.036	.012	.003
		W	.28	.17	.12	.078	.040	.011
Trees but no Low Brush (13')	25	G	.42	.19	.10	.041	.013	.003
		W	.42	.23	.14	.089	.042	.011
Low Brush (13')	50	G	.39	.18	.09	.040	.013	.003
		W	.39	.21	.14	.087	.042	.011
	75	G	.36	.17	.09	.039	.012	.003
		W	.36	.20	.13	.084	.041	.011

SOURCE: USDA Agricultural Handbook Number 537, December 1978.

APPENDIX B - SOIL LOSS CALCULATION TABLES - Continued

TABLE 10-5 PRACTICE FACTOR VALUES (P) FOR GRADIENT TERRACES, EARTH DIKES, INTERCEPTOR DIKES AND SWALES	
LAND SLOPE (Percent)	PRACTICE FACTOR
1 - 2	0.60
3 - 8	0.50
9 - 12	0.60
13 - 16	0.70
17 - 20	0.80
21 - 25	0.90

SOURCE: CITY OF LITTLE ROCK.

TABLE 10-6 PRACTICE FACTOR VALUES (P) FOR BUFFER ZONES, FILTER STRIPS AND NATURAL VEGETATION			
LAND SLOPE (Percent)	STRIP WIDTH	SLOPE LENGTH MAX.	PRACTICE FACTOR
1 - 2	25	150	0.60
	50	300	0.60
3 - 5	25	150	0.50
	50	300	0.50
6 - 8	25	100	0.50
	50	200	0.50
9 - 12	25	75	0.60
	50	150	0.60
13 - 16	25	50	0.70
	50	100	0.70
17 - 20	25	50	0.80
	50	100	0.80
21 - 25	25	25	0.90
	50	50	0.90

SOURCE: CITY OF LITTLE ROCK.

APPENDIX C - EROSION AND SEDIMENTATION CONTROLS

Erosion and Sedimentation Control Illustrations

Check Dams
Diversion Dike
Drainage Swale
Filter Strips
Gradient Terraces
Gravel or Stone Filter Berm
Interceptor Dikes and Swales
Outlet Protection
Pipe Slope Drains
Silt Fence
Stabilized Construction Entrance
Storm Drain inlet Protection
Straw Bale Barrier
Stream Bank Stabilization

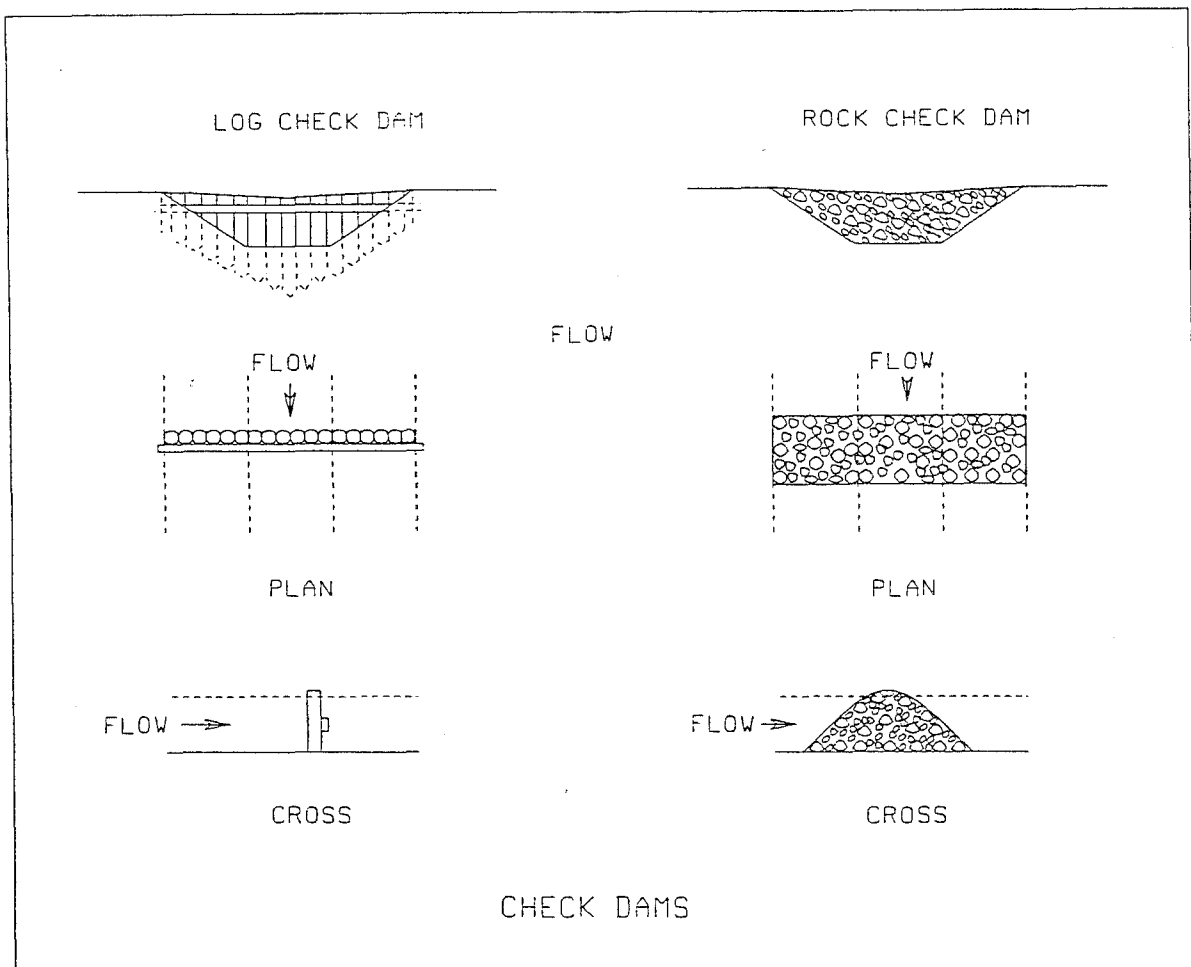

APPENDIX C - EROSION AND SEDIMENTATION CONTROLS

Check Dams

A check dam is a small, temporary or permanent dam constructed across a drainage ditch, swale or channel to reduce the speed of concentrated flows. Check dams can be installed in steeply sloped swales, or in channels where adequate vegetative cover can not be established. Check dams may be constructed of logs, rock, or gravel-filled sand bags.

Check dams should only be used in small open channels where the dam will not be overtopped by flowing water once the dam is constructed. The center section of the dam should always be built lower than the edges. The toe of the upstream check dam should be at the same elevation as the top of the downstream dam. Check dams should be inspected after each significant rain event, and sediment should be removed when it reaches one-half of the original dam height.

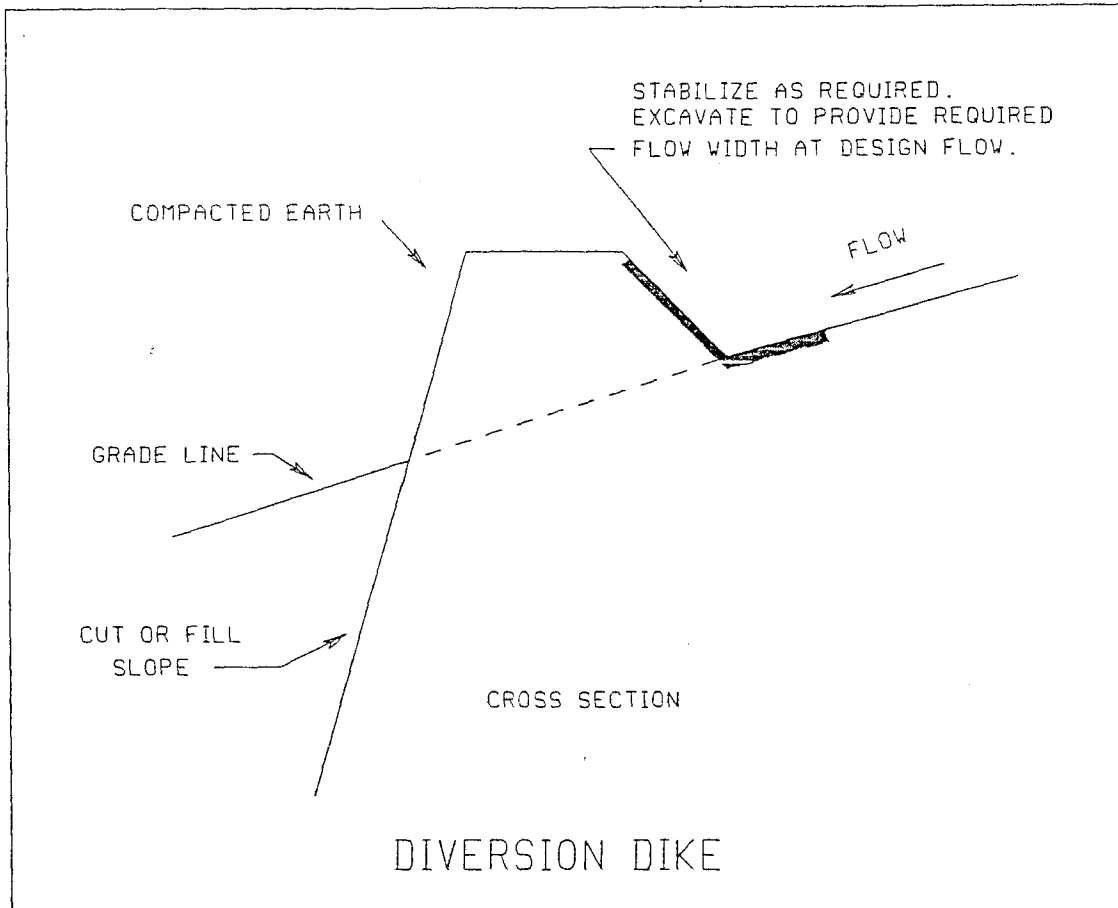

APPENDIX C - EROSION AND SEDIMENTATION CONTROLS - Continued

Diversion Dike

A diversion dike is a ridge or ridge and swale combination used to protect work areas from up-slope runoff and divert sediment-laden waters to appropriate sediment traps or stabilized outlets. The dike consists of a compacted soil berm and a gravel, vegetation or fabric-lined swale.

Diversion dikes can be used above or below disturbed areas and unprotected slopes to reduce erosion. Diversion dikes can also be used along the perimeter of the construction site to prevent sedimentation of off-site properties and the municipal storm drain. Diversion dikes should be inspected regularly and after each rain event.

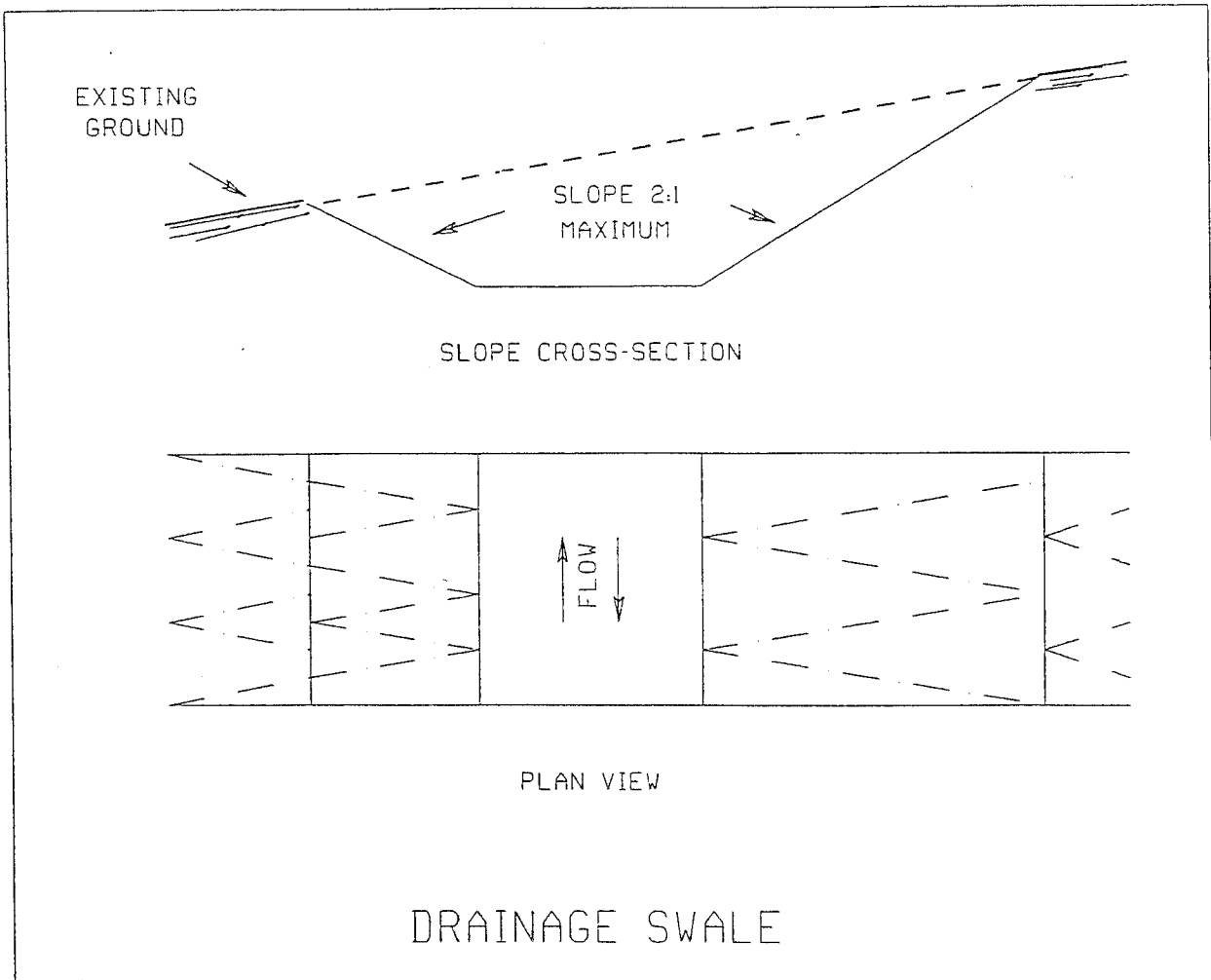

APPENDIX C - EROSION AND SEDIMENTATION CONTROLS - Continued

Drainage Swale

A drainage swale is a constructed channel with a lining of vegetation, riprap, concrete, asphalt or geotextile applied to provide stabilization and prevent channel erosion. Drainage swales are used to convey runoff without causing erosion, such as from the top or bottom of a slope. Drainage swales discharge a concentrated flow to a sediment trapping device or stable outlet.

Drainage swales should be carefully designed to provide a positive grade and prevent ponding of channel flow. Suitable channel protection depends upon the design flow and grade of the channel. Drainage swales are restricted to use on relatively flat slopes.

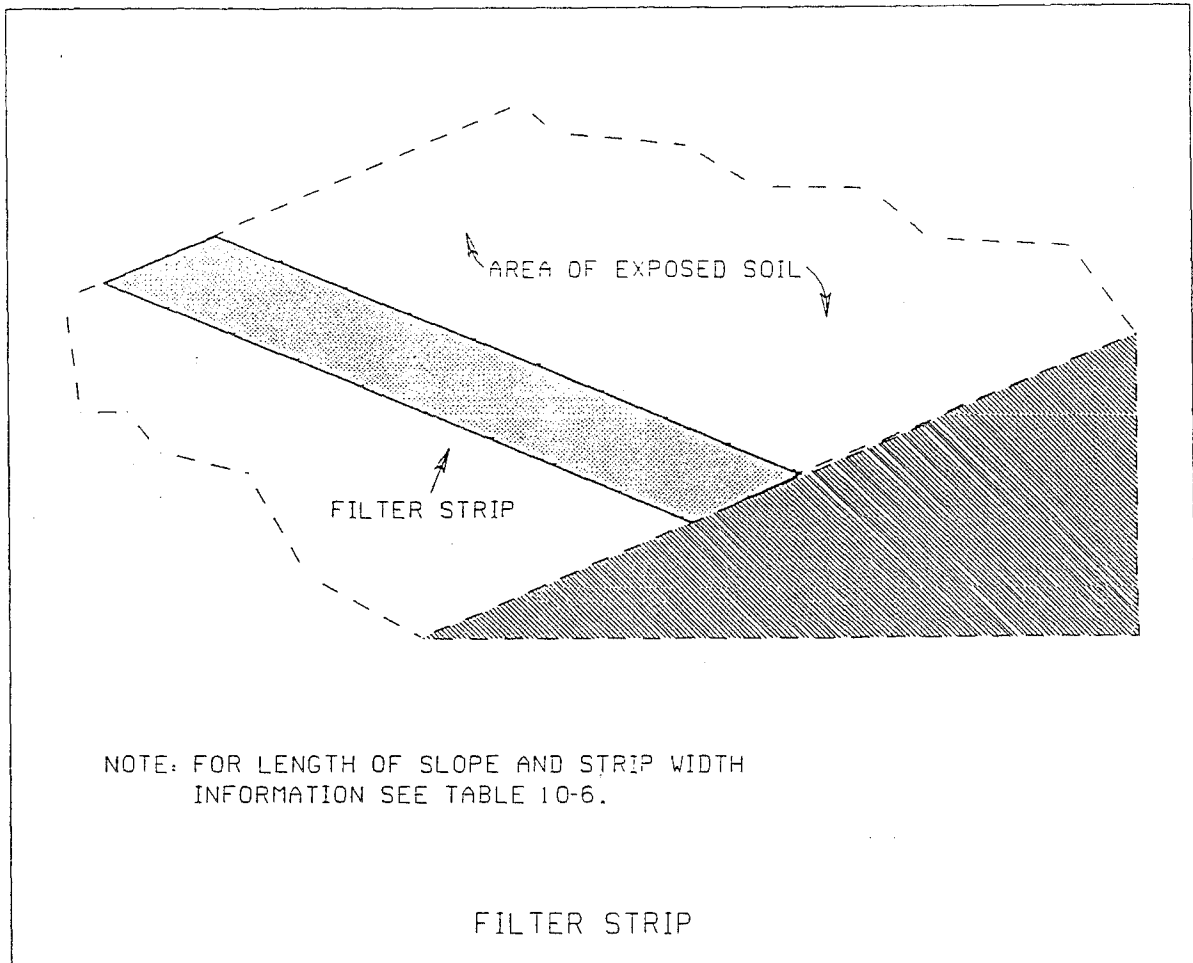

APPENDIX C - EROSION AND SEDIMENTATION CONTROLS - Continued

Filter Strips

Filter strips are undisturbed vegetated strips of land which control erosion by reducing the speed of runoff and allowing runoff to infiltrate into the ground. Filter strips should be aligned perpendicular to the line of flow and are effective on gentle slopes where adequate space exists to leave undisturbed areas.

Filter strips are also effective along the perimeter of the development site, preventing off-site sedimentation. A minimum width of twenty-five feet is required for filter strips. Filter strips require no maintenance, but must be undisturbed by construction activities to remain effective.

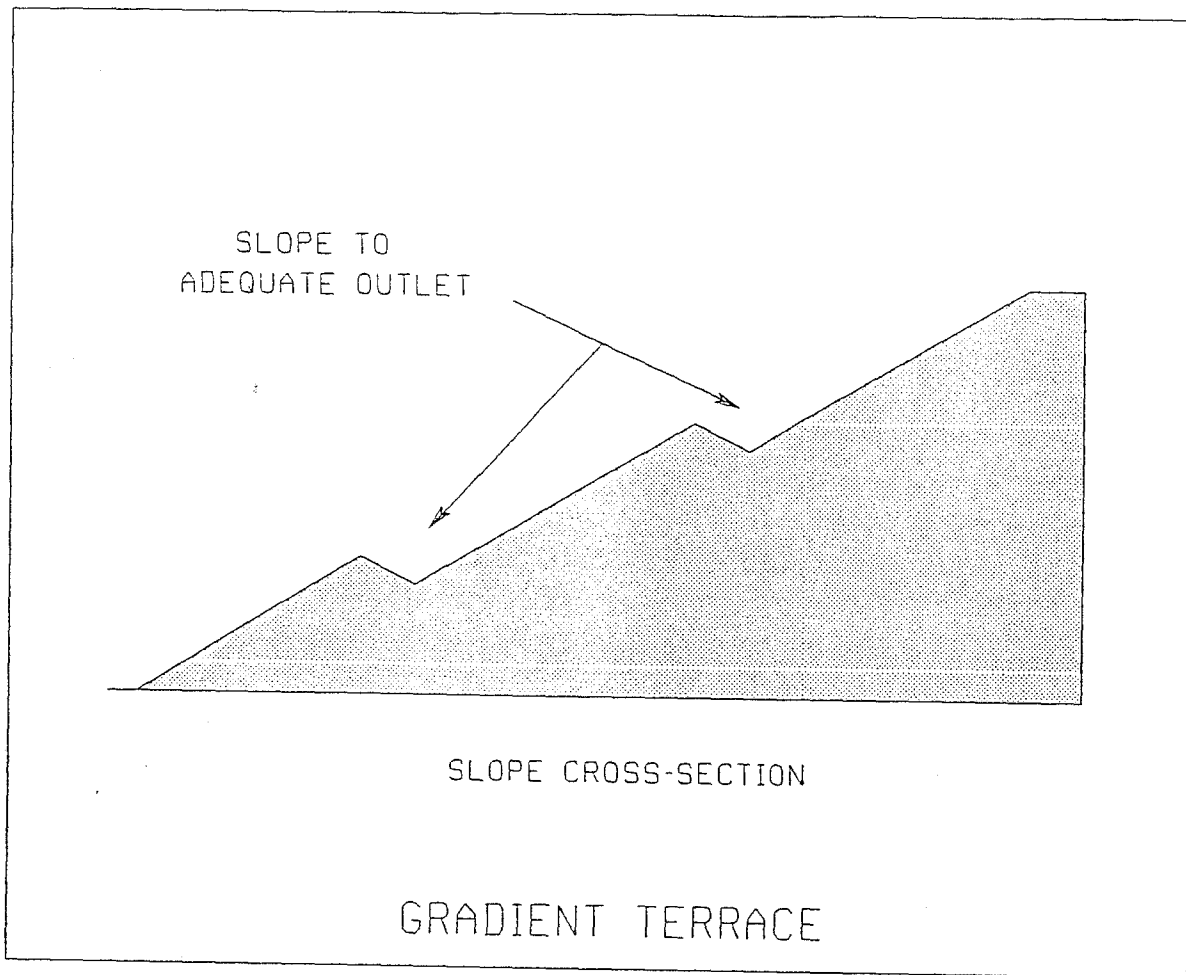

APPENDIX C - EROSION AND SEDIMENTATION CONTROLS - Continued

Gradient Terraces

Gradient terraces are earthen embankments constructed at regular intervals along the face of a slope. Gradient terraces must be built with a positive grade which directs flow to a stable outlet at a speed which minimizes erosion.

Gradient terraces are used on long, steep slopes where erosion potential is anticipated to be a problem. Gradient terraces can be either temporary or permanent features. Terraces should be inspected at regular intervals and after major rain events to insure proper operation.

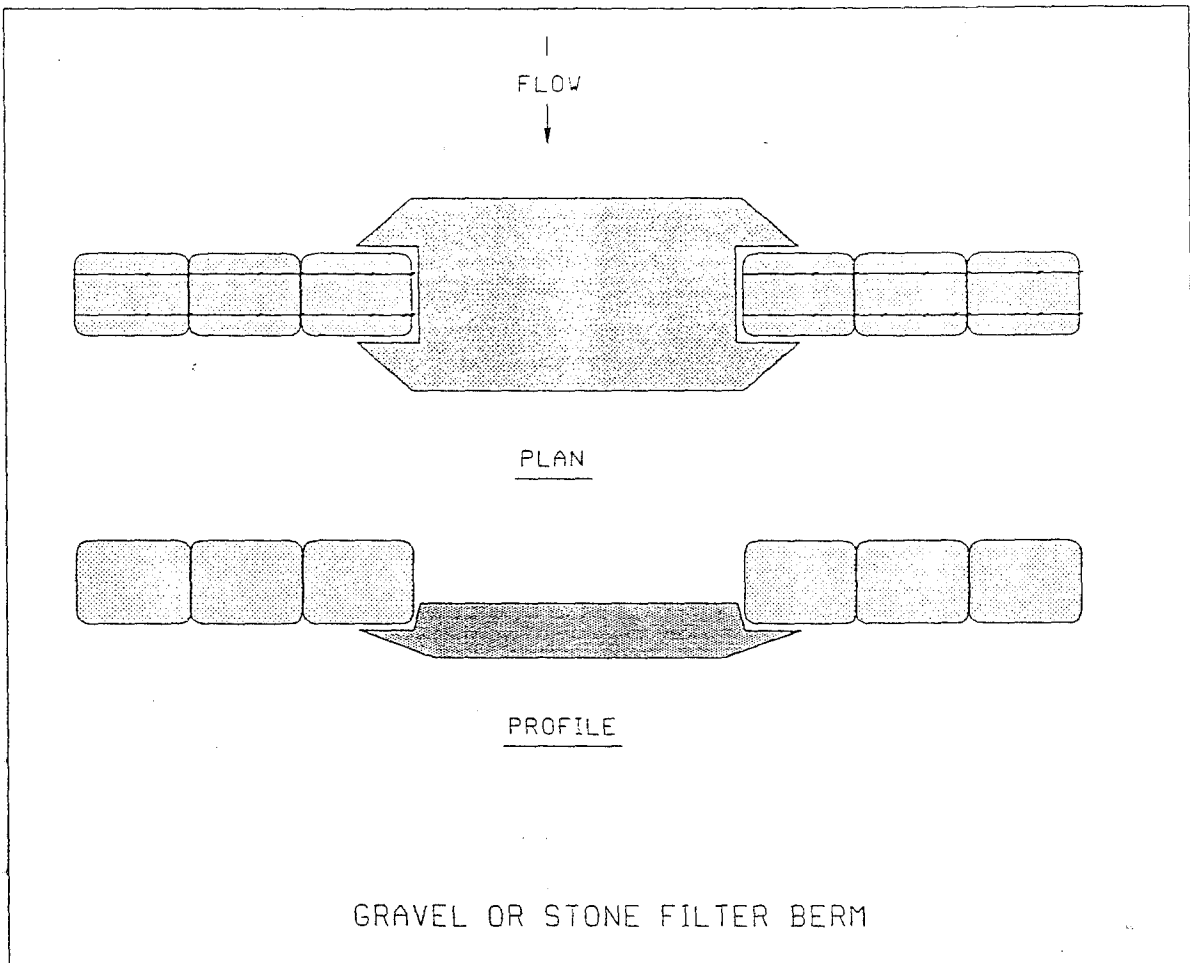

APPENDIX C - EROSION AND SEDIMENTATION CONTROLS - Continued

Gravel or Stone Filter Berm

A gravel or stone filter berm is a temporary ridge constructed of loose gravel, crushed rock or stone. A gravel or stone filter berm slows and filters flow, reducing the amount of sediment carried off-site.

Berm are meant for use in areas with gentle slopes. Berm materials should be well graded gravel or crushed stone. The berm should be inspected regularly and after each rain event. Accumulated sediment should be removed and properly disposed of, and the filter material should be cleaned or replaced regularly.

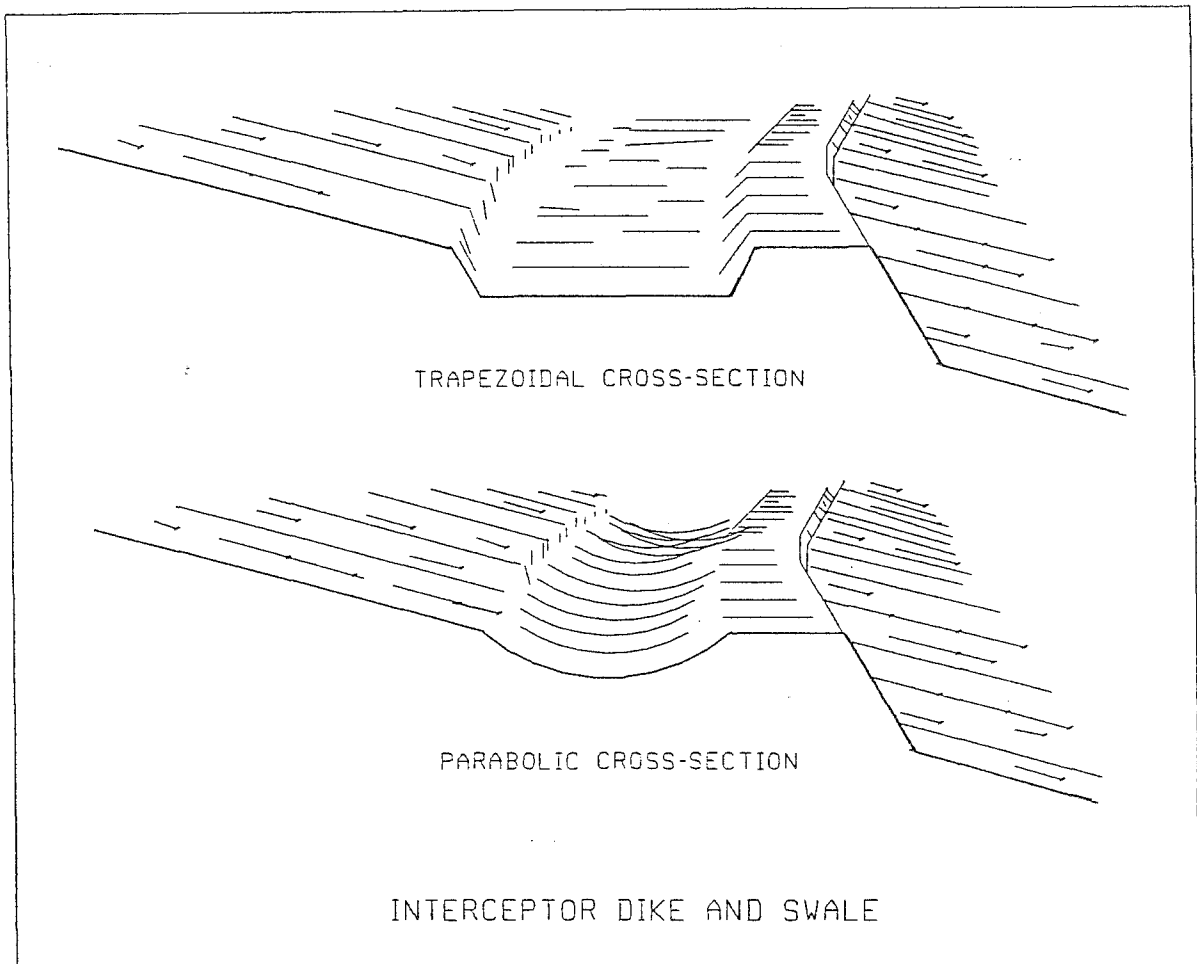

APPENDIX C - EROSION AND SEDIMENTATION CONTROLS - Continued

Interceptor Dikes and Swales

Interceptor dikes and swales are used to keep up-slope runoff from crossing areas exposed by construction. Interceptor dikes and swales reduce the speed of flow and direct it to a stabilized outlet. Interceptor dikes and swales can be either temporary or permanent controls.

Interceptor dikes and swales can be placed around the perimeter of the construction site, to divert flow away from disturbed areas and to direct sediment-laden flow from disturbed areas to sediment trapping devices. Interceptor dikes and swales must be constructed with a positive grade, and the speed of flow within the swale must not cause erosion. All dikes and swales should be inspected weekly and after rain events, and temporary dikes and swales should be rebuilt every two weeks during the construction period.

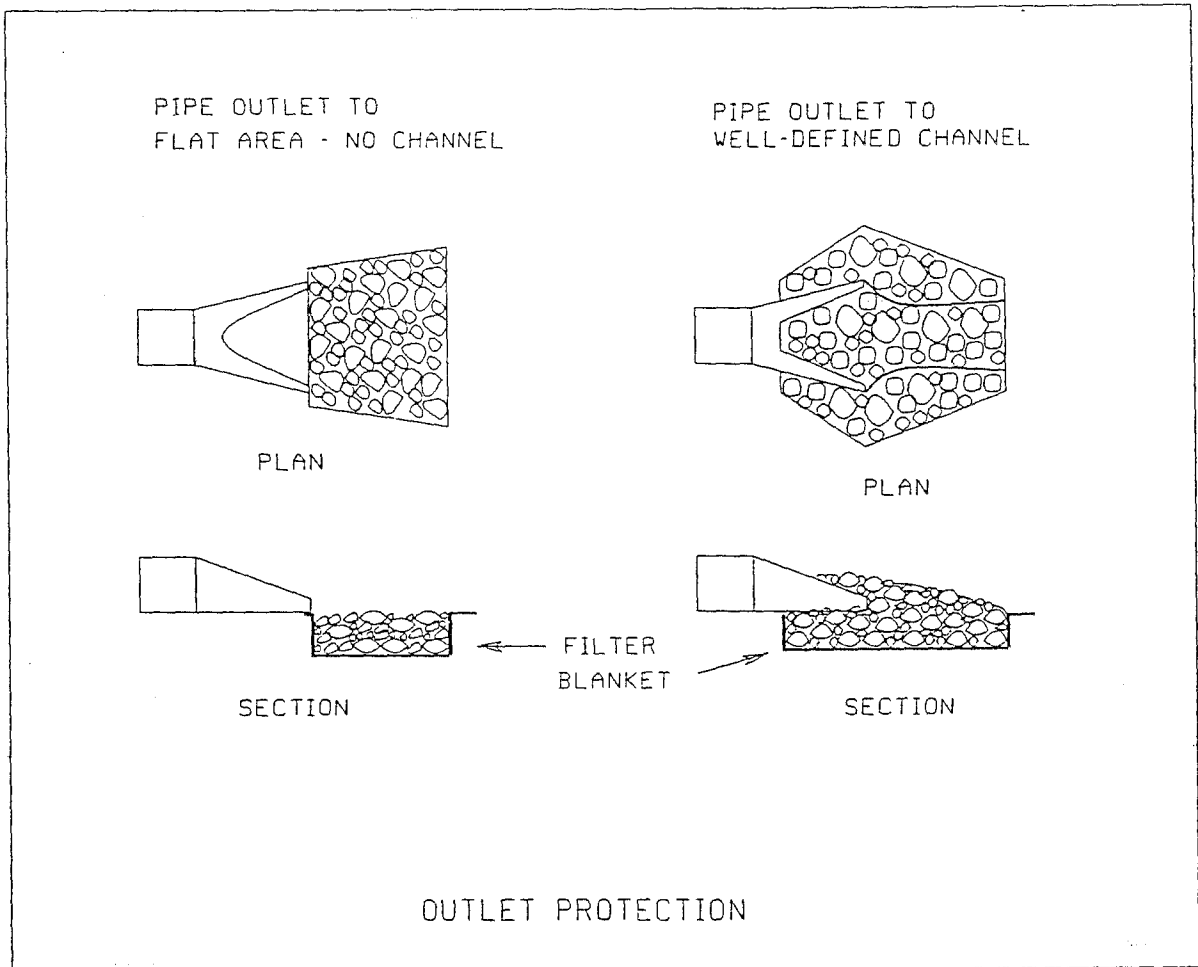

APPENDIX C - EROSION AND SEDIMENTATION CONTROLS - Continued

Outlet Protection

Outlet protection reduces erosion and scouring at stormwater outlets by lowering the speed of concentrated flows. This also reduces the potential for erosion downstream and on adjacent properties. Outlet protection can include stone or riprap, concrete aprons, paving or settling basins below outfalls. Outlet protection is generally a permanent control.

Outlet protection should be provided wherever pipe, dike and swale, or channel section outlet velocities may cause erosion. Outlet protection should be inspected regularly for erosion and scouring, and repaired immediately.

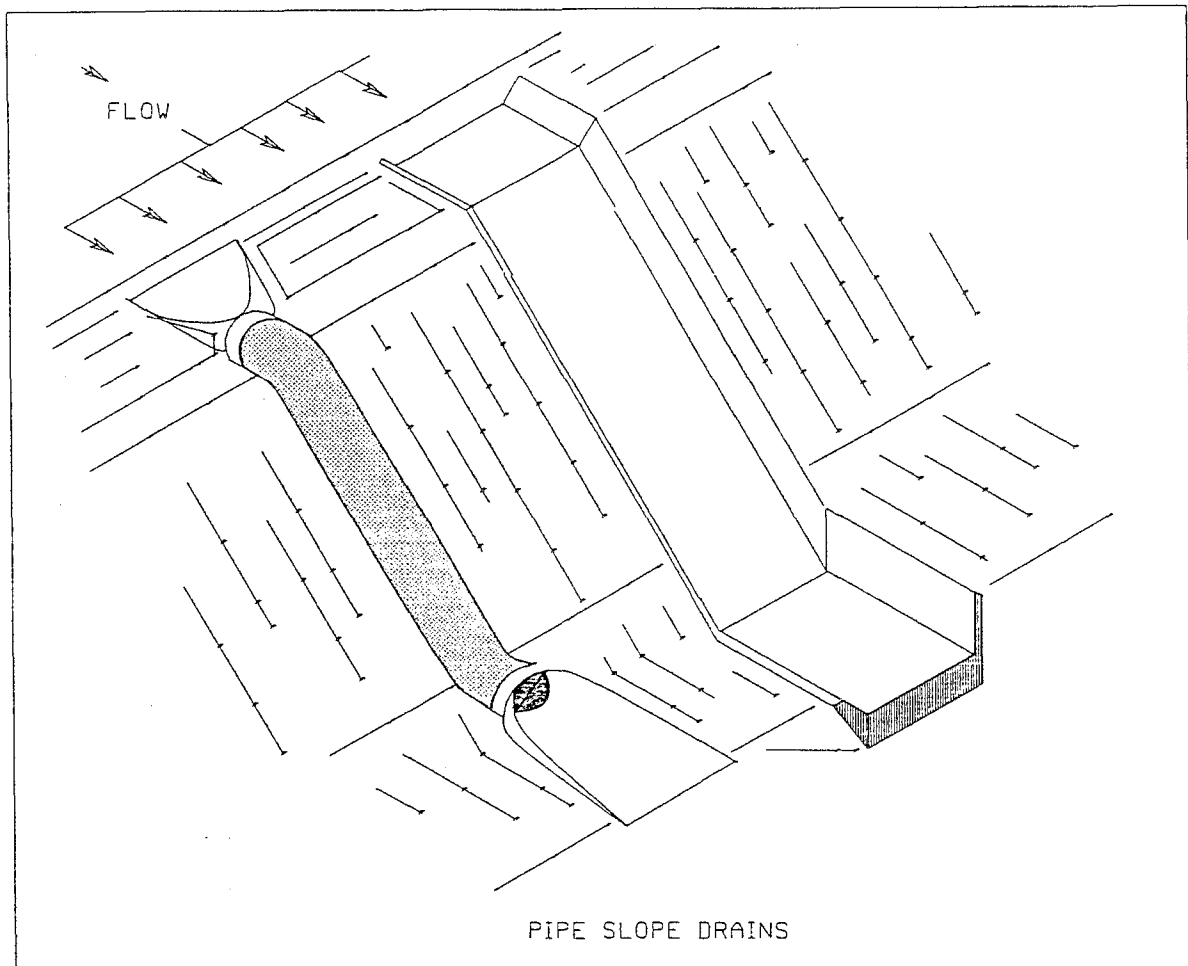

APPENDIX C - EROSION AND SEDIMENTATION CONTROLS - Continued

Pipe Slope Drains

Pipe slope drains reduce runoff potential by transporting runoff to stabilized areas or outfalls. They may be constructed of flexible or rigid pipe, or open swales, and can be either temporary or permanent control features. Pipe slope drains are effective in transporting runoff away from saturated slopes which have a potential for failure.

Pipe slope drains must be designed for the anticipated volume of flow. Both the inlet and outlet structures must be stabilized with end sections, riprap or geotextiles to prevent scouring and erosion. The pipe slope drain should be regularly inspected for erosion, undercutting, breaks and clogs. Repairs should be made immediately.

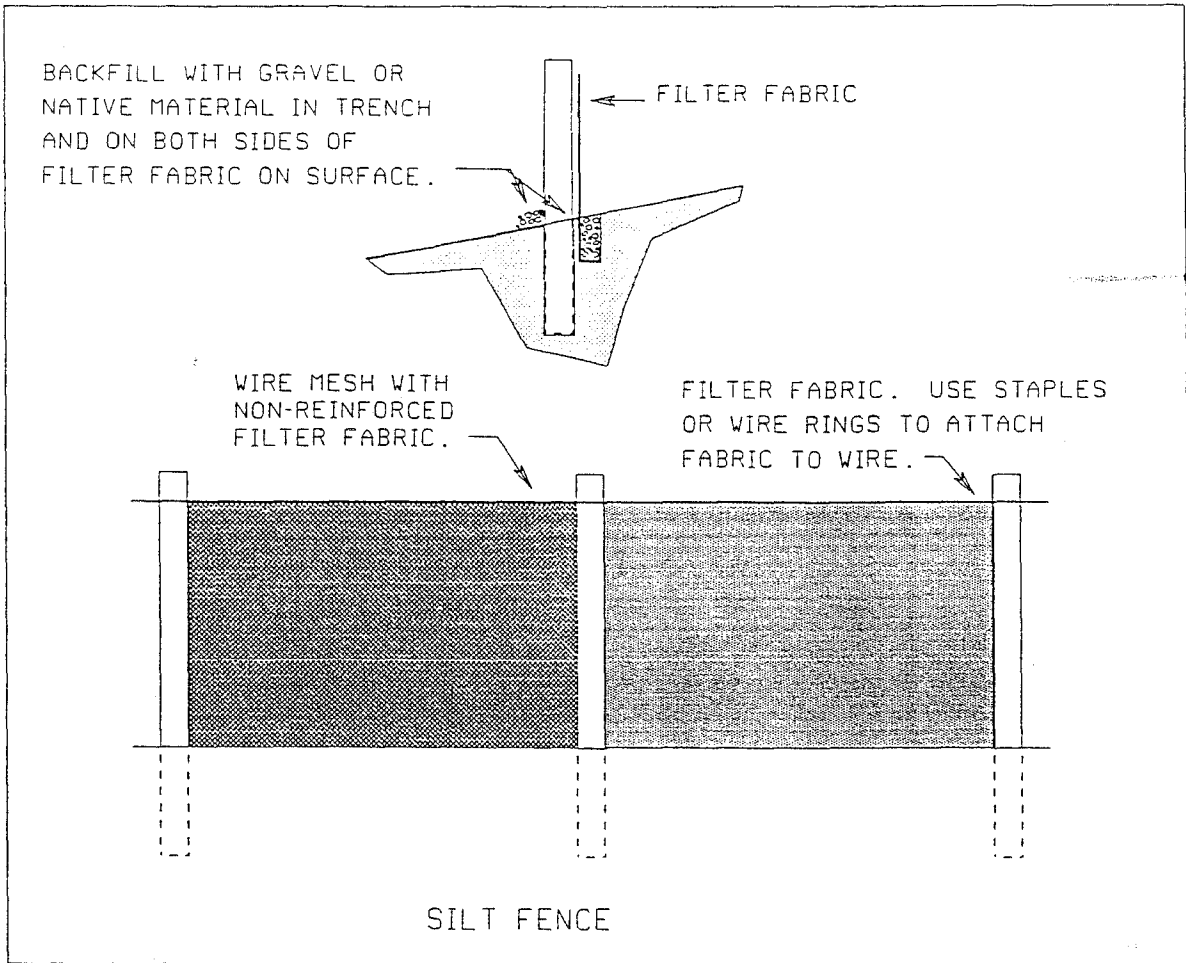

APPENDIX C - EROSION AND SEDIMENTATION CONTROLS - Continued

Silt Fence

Silt fence, filter fence or filter fabric is a temporary sediment control measure for construction sites. Silt fence is usually constructed of filter fabric (with or without wire mesh fencing for support) placed on fence posts, with the lower edge vertically trenched and backfilled. Silt fencing is effective in filtering overland flow from small drainage areas.

Silt fencing should be installed prior to land disturbance activities, along a line of uniform elevation. Silt fence is effective along the bottom of slopes and around the perimeter of the construction site. Silt fence must be properly installed and frequently inspected for sags and erosion under the fence. Silt should be removed from the fence line and properly disposed of when it reaches one-third the height of the fence.

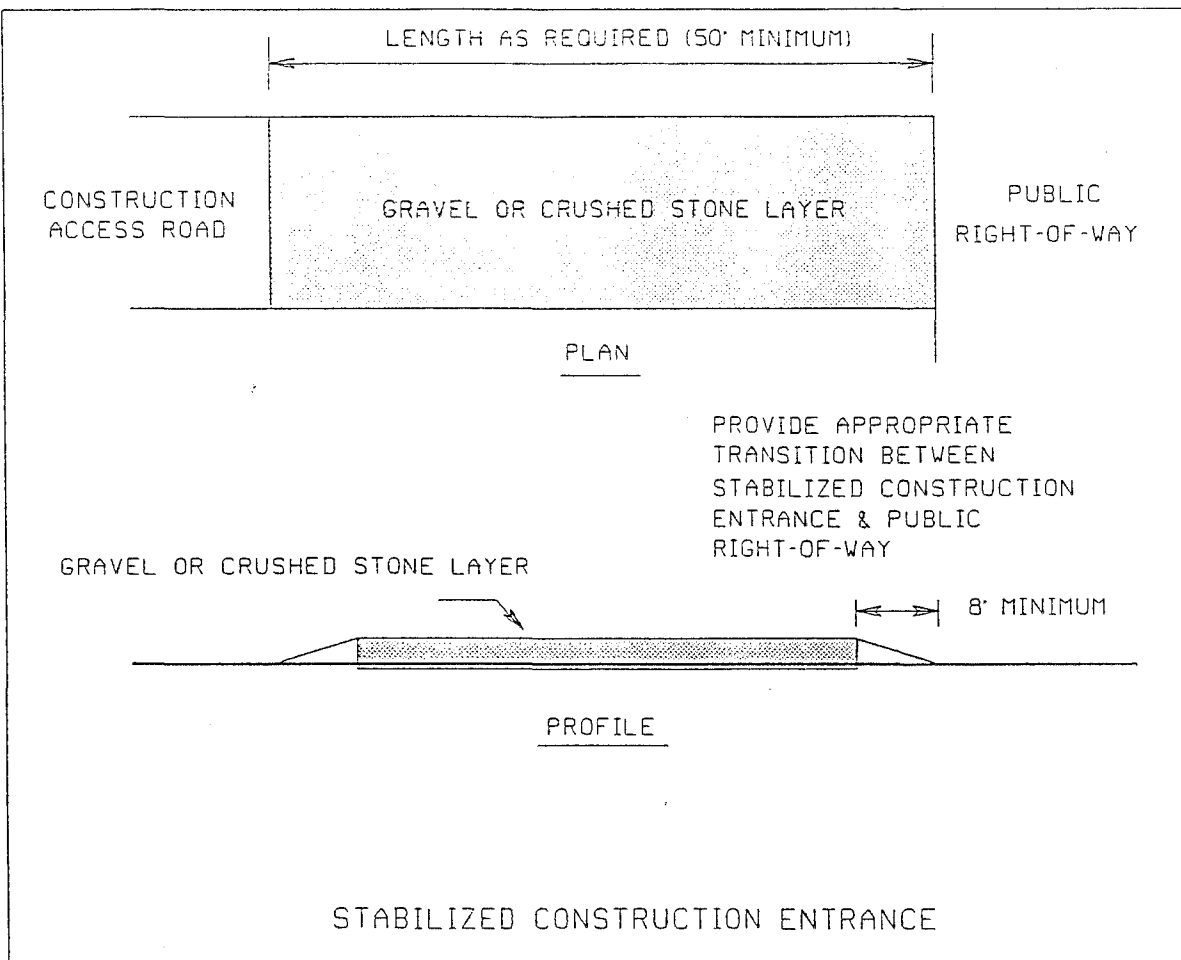

APPENDIX C - EROSION AND SEDIMENTATION CONTROLS - Continued

Stabilized Construction Entrance

A stabilized construction entrance is a portion of the construction access road adjacent to public rights-of-way which is constructed of geotextile (filter fabric) and large stone. A stabilized construction entrance reduces the amount of soil tracked off-site by construction vehicles and equipment. The stone base also protects the portion of the road where the control is placed from erosion and rutting.

Stabilized construction entrances should be constructed before site work begins at every point where vehicles will leave the site. The entrance should be constructed with adequate width and length to accommodate the largest construction equipment being used at the site. Vehicle washing may also be employed over stabilized construction entrances. The stone base should be maintained and kept free of sediment accumulation.

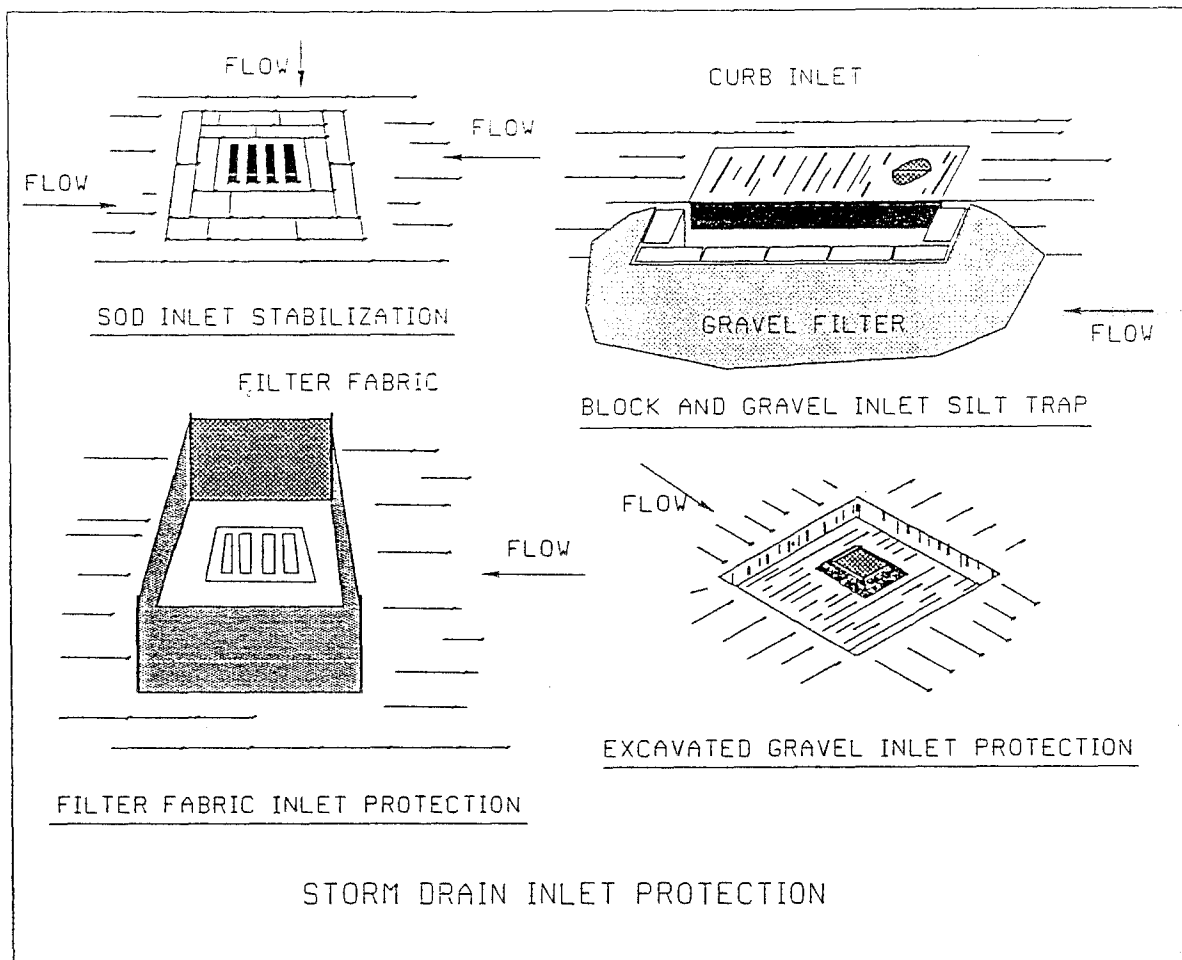

APPENDIX C - EROSION AND SEDIMENTATION CONTROLS - Continued

Storm Drain Inlet Protection

Storm drain inlet protection is a filtering measure placed around existing or constructed inlets and drains to trap sediment. This prevents silting-up of the storm drainage system and receiving streams. Inlet protection can be constructed with stone or gravel and wire mesh, concrete block and gravel, sod and/or filter fabric. Inlet protection is a temporary control during construction.

Storm drain inlet protection is not meant for drainage areas larger than one acre, or for concentrated flows. Inlet protection is used in combination with other controls, such as sediment trapping devices. Repairs and silt removal should be performed as needed, and the inlet protection should be regularly inspected.

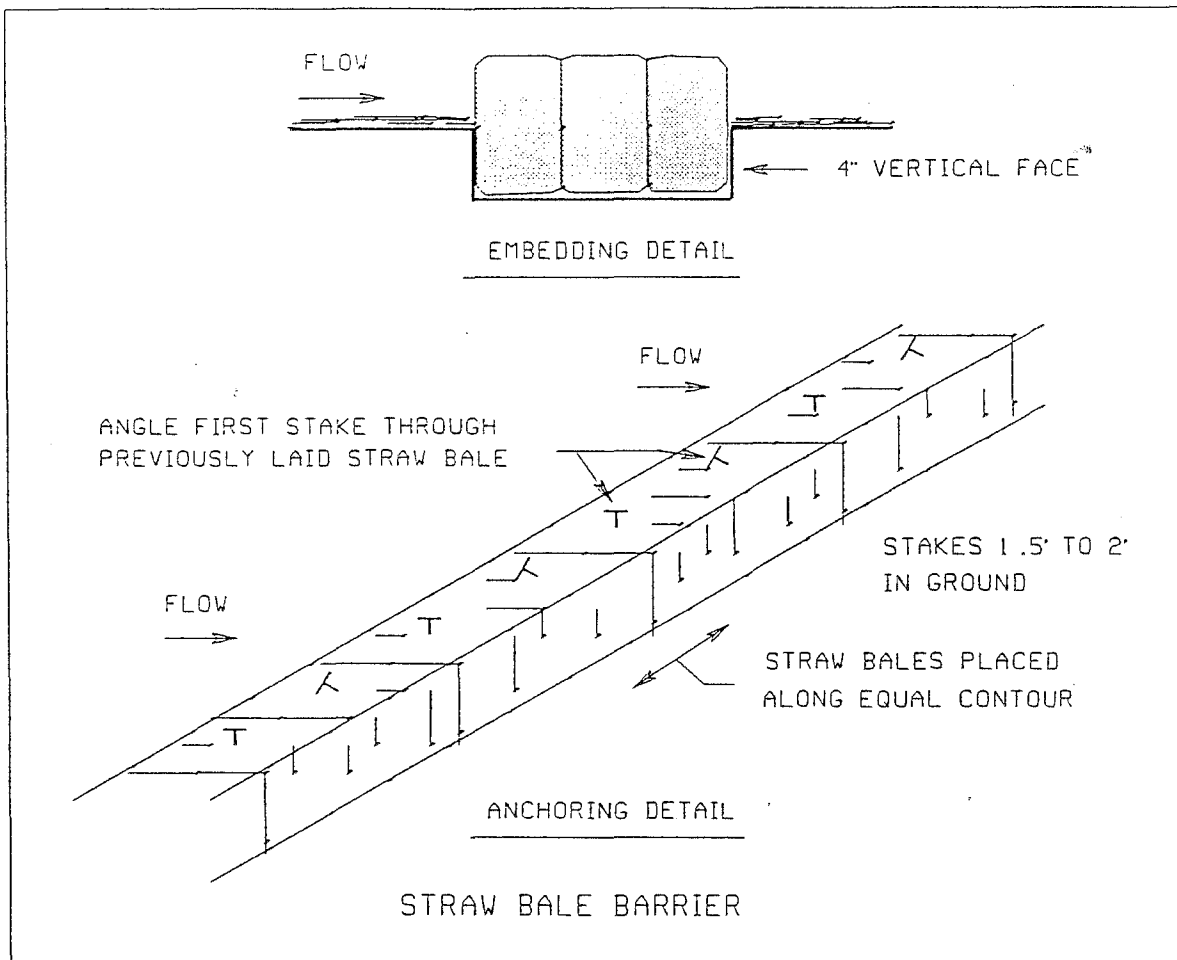

APPENDIX C - EROSION AND SEDIMENTATION CONTROLS - Continued

Straw Bale Barrier

Straw bale barriers act as diversion dikes where site conditions prohibit the use of on-site soil in the construction of dikes and swales. Straw bale barriers are also effective above site slopes on undisturbed areas, and can be used below the site to divert flow to stabilized outlets or sediment trapping devices. Straw bale barriers are a temporary control during construction.

Straw bale barriers placed in disturbed areas should be embedded. Where straw bale barriers are placed on undisturbed ground, embedding is not necessary. All straw bale barriers must be properly installed and staked in place. Straw bale barriers should be inspected regularly and repaired or replaced when necessary.

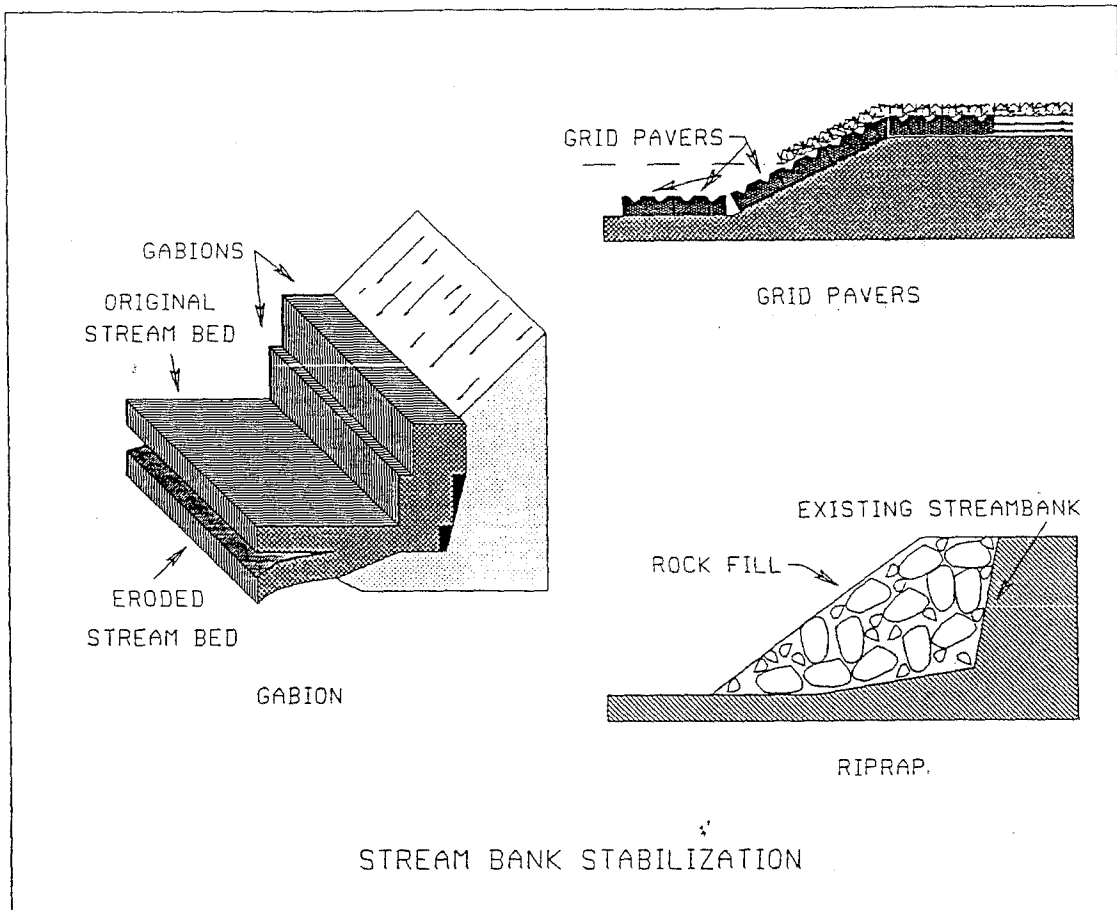

APPENDIX C - EROSION AND SEDIMENTATION CONTROLS - Continued

Stream Bank Stabilization

Stream bank stabilization is used to prevent erosion of existing stream banks from increased flows and runoff speeds caused by development. Stream bank stabilization is necessary where vegetative controls are not practical. Stream bank stabilization can be either temporary or permanent, and can include riprap, gabions, grid pavers, asphalt or other materials.

Stream bank stabilization should be designed by a professional engineer. Clearance and permits should be obtained as necessary from local, state and federal agencies before stream bank stabilization measures are used. Once placed, stream bank stabilization measures should be inspected regularly and repaired as necessary.

APPENDIX D - REFERENCES

City of Little Rock, "Stormwater Management And Drainage Manual", Department of Public Works, Engineering Division, Little Rock, Arkansas, 1985.

City of Little Rock, "Site Development Guide", Department of Public Works and Others, Little Rock, Arkansas, January, 1993.

United States Environmental Protection Agency, Office of Water, "Storm Water Management For Construction Activities", Developing Pollution Prevention Plans And Best Management Practices, EPA 832-R-92-005, Washington, D.C., September 1992.

Wischmeier, W.H., and Smith, D.D.. "Predicting Rainfall Erosion Losses - A Guide To Conservation Planning", Agriculture Handbook Number 537, United States Department of Agriculture, Science and Education Administration, Washington, D.C. 1978.

XI - MISCELLANEOUS